

ZFT460-FT LED

Street and Area Lighting

we-ef



Description

IP66. Post top luminaire with shielded light source and canopy highlight feature.

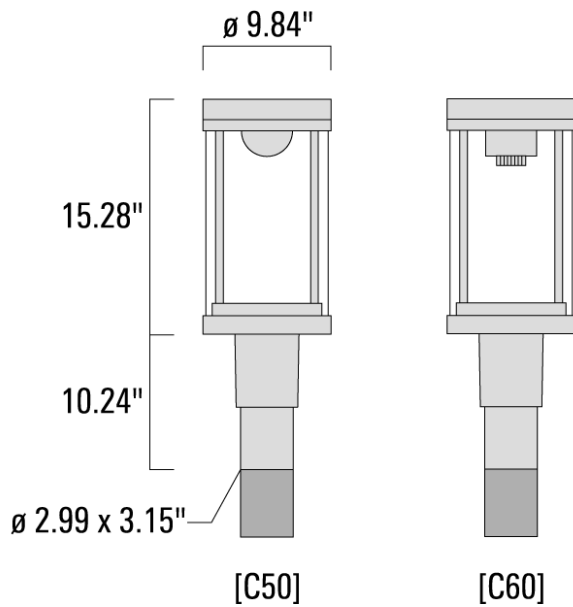

WE-EF LIGHTING USA, LLC

410-D Keystone Drive, 15086 Warrendale, PA 15086 - Phone: +1 724 742 0030
customersupport.usa@we-ef.com - <https://we-ef.com/us>





Subject to technical changes and errors. - Generated on 10/23/2024

ZFT460-FT LED

Street and Area Lighting

Specifications

Material description

Body	Marine-grade, die-cast aluminium alloy
Lens	PMMA
Colors	 RAL9004 Black  RAL9007 Grey Metallic  RAL9016 White  RAL8019 Dark Bronze
Gasket	Silicone CCG® Controlled Compression Gasket
Fasteners	PCS Polymer Coated Stainless Steel Hardware
Ingress protection	IP66
Impact resistance	IK08
Corrosion resistance	5CE
Windage	0.162 m ²

Electrical description

Power supply	220-240V / 50-60 Hz
Driver / Ballast	Integral EC electronic converter
Power factor	> 0.9

Additional information

Lifetime	Ta=25°/40° L70B50 > 50000h
----------	----------------------------

WE-EF LIGHTING USA, LLC

410-D Keystone Drive, 15086 Warrendale, PA 15086 - Phone: +1 724 742 0030

customersupport.usa@we-ef.com - <https://we-ef.com/us>

Subject to technical changes and errors. - Generated on 10/23/2024

ZFT460-FT LED

Street and Area Lighting



Options

Light distribution Color temperature Nominal Watt

WE-EF LIGHTING USA, LLC

410-D Keystone Drive, 15086 Warrendale, PA 15086 - Phone: +1 724 742 0030

customersupport.usa@we-ef.com - <https://we-ef.com/us>

Subject to technical changes and errors. - Generated on 10/23/2024

ZFT460-FT LED

Street and Area Lighting



Configurations

Light distribution	Part ID	Light source	Rated lumens	Rated input power	CRI	Weight (lb)
--------------------	---------	--------------	--------------	-------------------	-----	-------------

WE-EF LIGHTING USA, LLC

410-D Keystone Drive, 15086 Warrendale, PA 15086 - Phone: +1 724 742 0030

customersupport.usa@we-ef.com - <https://we-ef.com/us>

Subject to technical changes and errors. - Generated on 10/23/2024

Mounting Accessories

Wall and pole brackets RZ

Description	Part ID	C1	D1	D2	D x L1	M1	Weight (lb)
RZ0-400 Wall bracket, single	115-1324	10.90"	9.1"	7.67"	3" x 3"	0.47"	7.72 lbs

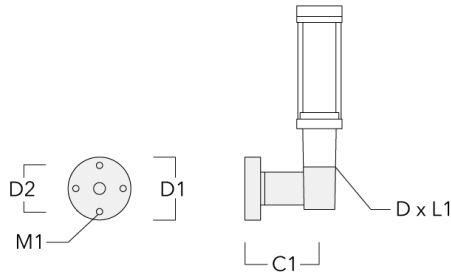

RZ2-400 Pole bracket, double	115-1323	10.16"			3" x 3"		10.8 lbs
------------------------------	----------	--------	--	--	---------	--	----------

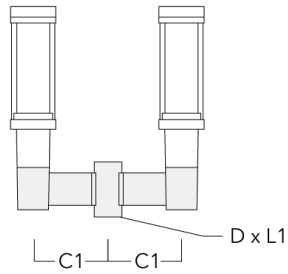

ZFT460-FT LED
Street and Area Lighting

WE-EF LIGHTING USA, LLC

410-D Keystone Drive, 15086 Warrendale, PA 15086
Phone: +1 724 742 0030

customersupport.usa@we-ef.com
<https://we-ef.com/us>

Subject to technical changes and errors.
Generated on 10/23/2024