

# ZFT470-FT LED

Pole mounted

**we-ef**

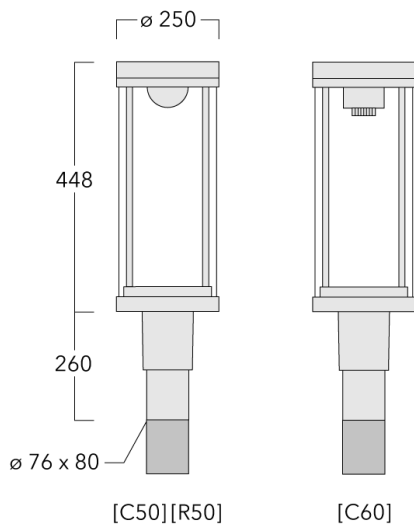





## Description

IP66, Class I. Class II on request. IK08. Marine-grade, die-cast aluminium alloy. 5CE superior corrosion protection including PCS hardware. Silicone CCG<sup>®</sup> Controlled Compression Gasket. PMMA main lens. The luminaire is factory sealed and does not need to be opened during installation. Integral EC converter. Factory installed LED circuit board. Removable LED boards for upgrading. CAD-optimised indirect optics for superior illumination and glare control.

**Pole mounted****Specifications****Material description**

---

Body	Marine-grade, die-cast aluminium alloy
Lens	PMMA
Colours	 RAL9004 Signal black  RAL9006 White aluminium  RAL9007 Grey aluminium  RAL7016 Anthracite grey  RAL9016 Traffic white
Gasket	Silicone CCG® Controlled Compression Gasket
Fasteners	PCS Polymer Coated Stainless Steel Hardware
Ingress protection	IP66
Impact resistance	IK08
Corrosion resistance	5CE
Windage	0.177 m <sup>2</sup>

---

**Electrical description**

---

Power supply	220-240V / 50-60 Hz
Driver / Ballast	Integral EC electronic converter
Power factor	> 0.9
Surge protection	6/6 kV (optional SP10)

---

**Additional information**

---

Lifetime	Ta=25° L70B50 > 50000h
Energy efficiency class	C-D (Light source)

---

# ZFT470-FT LED

Pole mounted

**we-ef**

## Options

### Light distribution



symmetric distribution [C60]



controlled symmetric distribution [C50]



rectangular [R50]

### Colour temperature



4000 K



3000 K





2700 K

### Nominal Watt

0 W

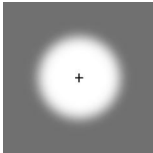
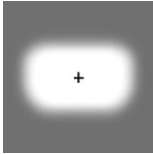
## Configurations

Light distribution	Part ID	Light source	Rated lumens	Rated input power	CRI	Weight (kg)
controlled symmetric distribution [C50] 	115-1549	LED-FT-24W / 700 mA - 3000 K	3345.5	27 W	80	7.90
	115-1550	LED-FT-24W / 700 mA - 4000 K	3488.2	27 W	80	7.90
	115-1551	LED-FT-37W / 700 mA - 3000 K	5018.3	42 W	80	7.90
	115-1552	LED-FT-37W / 700 mA - 4000 K	5307.7	42 W	80	7.90
	115-1595	LED-FT-24W / 700 mA - 2700 K	3210.8	27 W	80	7.90
	115-1596	LED-FT-37W / 700 mA - 2700 K	4871.6	42 W	80	7.90
rectangular [R50] 	115-1844	LED-FT-24W / 700 mA - 3000 K	3347.6	27 W	80	7.90
	115-1874	LED-FT-24W / 700 mA - 4000 K	3490.3	27 W	80	7.90
	115-1875	LED-FT-24W / 700 mA - 2700 K	3212.7	27 W	80	7.90
	115-1876	LED-FT-37W / 700 mA - 3000 K	5021.3	42 W	80	7.90
	115-1877	LED-FT-37W / 700 mA - 4000 K	5310.9	42 W	80	7.90
	115-1878	LED-FT-37W / 700 mA - 2700 K	4874.6	42 W	80	7.90
symmetric distribution [C60] 	115-1353	LED-FT-24W / 700 mA - 3000 K	3404.4	27 W	80	7.90
	115-1354	LED-FT-24W / 700 mA - 4000 K	3549.6	27 W	80	7.90
	115-1355	LED-FT-37W / 700 mA - 3000 K	5106.6	42 W	80	7.90
	115-1356	LED-FT-37W / 700 mA - 4000 K	5401	42 W	80	7.90
	115-1597	LED-FT-24W / 700 mA - 2700 K	3267.2	27 W	80	7.90
	115-1598	LED-FT-37W / 700 mA - 2700 K	4957.3	42 W	80	7.90

# ZFT470-FT LED

Pole mounted

**we-ef**

## Control

### Eco Step Dim® Basic

Description	Part ID
Eco Step Dim® Basic LED	430-0001

### Eco Step Dim® Advanced

Description	Part ID
Eco Step Dim® Advanced LED	430-0002

**Fagerhult Lighting Ltd**

33-34 Dolben Street, SE1 0UQ London, United Kingdom

<https://we-ef.com/uk>

Subject to technical changes and errors. - Generated on 23/10/2024

Pole mounted

## Mounting Accessories

### Wall and pole brackets RZ

Description	Part ID	C1	D1	D2	D × L1	M1	Weight (kg)
RZ0-400 Wall bracket, single	115-1324	277	231	195	76 x 80	12	3.50

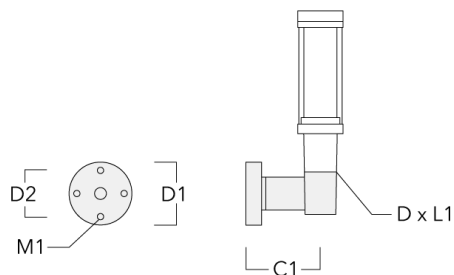

RZ2-400 Pole bracket, double	115-1323	258			76 x 100		4.90
------------------------------	----------	-----	--	--	----------	--	------

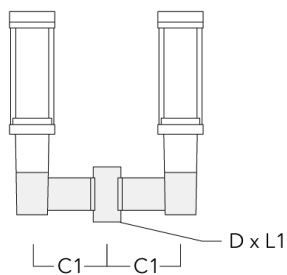

Pole mounted

### Optical Accessories

#### Light shield

---

Description	Part ID	H1
LS180-[C60]	159-0321	120

---

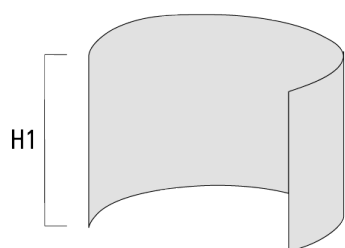

**ZFT470-FT LED**

**Pole mounted**

**Fagerhult Lighting Ltd**

33-34 Dolben Street, SE1 0UQ London, United Kingdom

<https://we-ef.com/uk>

Subject to technical changes and errors.  
Generated on 23/10/2024