

EFL540 LED

Pole mounted

we-ef

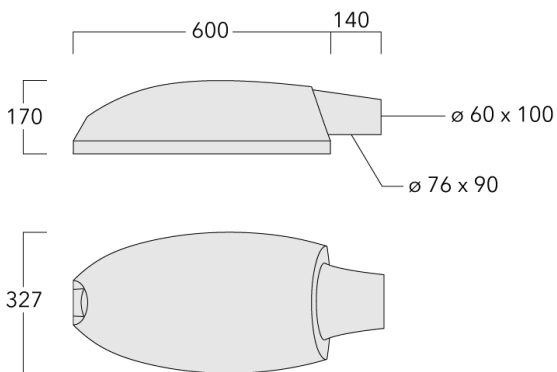

Description

IP66, Class I. IK08. Marine-grade die-cast aluminium alloy. 5CE superior corrosion protection including PCS hardware. Silicone CCG[®] Controlled Compression Gasket. Safety glass lens, hinged. Integral EC electronic converter. CAD- optimised OLC[®] PMMA lens. Integrated surge protection 6/6kV. Optional 2200 K version available. To be specified at time of ordering.

WE-EF LIGHTING (Thailand) Co., Ltd.

57 Moo 5, Kingkaew Rd., Bangplee, 10540 Samutprakarn - Phone: +66 2 738 96 20 - Fax: +66 2 738 96 29

<https://we-ef.com/asia>

Subject to technical changes and errors. - Generated on 23/11/2024





EFL540 LED

Pole mounted

we-ef

Specifications

Material description

Body	Marine-grade, die-cast aluminium alloy
Lens	Safety glass lens, hinged
Colours	 RAL9004 Signal black  RAL9007 Grey aluminium  RAL7016 Anthracite grey  RAL9016 Traffic white
Gasket	Silicone CCG® Controlled Compression Gasket
Fasteners	PCS Polymer Coated Stainless Steel Hardware
Ingress protection	IP66
Impact resistance	IK08
Corrosion resistance	5CE
Windage	0.098 m ²

Electrical description

Power supply	220-240V / 50-60 Hz
Driver / Ballast	Integral EC electronic converter
Power factor	> 0.9

Additional information

Lifetime	Ta=25° L90B10 > 90000h
----------	------------------------

WE-EF LIGHTING (Thailand) Co., Ltd.

57 Moo 5, Kingkaew Rd., Bangplee, 10540 Samutprakarn - Phone: +66 2 738 96 20 - Fax: +66 2 738 96 29

<https://we-ef.com/asia>

Subject to technical changes and errors. - Generated on 23/11/2024

EFL540 LED

Pole mounted

Options

Light distribution



asymmetric, side throw [S65]



rectangular, side throw [R65]

Colour temperature



2700 K

Nominal Watt

43 W

61 W

EFL540 LED

Pole mounted

we-ef

Configurations

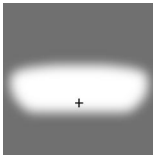
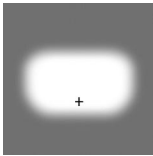
Light distribution	Part ID	Light source	Rated lumens	Rated input power	CRI	Weight (kg)
asymmetric, side throw [S65] 	107-0112	LED-18/36W / 700 mA - 2700 K	3894.3	41 W	80	9.90
	107-0113	LED-18/54W / 1050 mA - 2700 K	5913.5	59 W	80	9.90
rectangular, side throw [R65] 	107-0114	LED-18/36W / 700 mA - 2700 K	3547.9	41 W	80	9.90
	107-0115	LED-18/54W / 1050 mA - 2700 K	5387.5	59 W	80	9.90

WE-EF LIGHTING (Thailand) Co., Ltd.

57 Moo 5, Kingkaew Rd., Bangplee, 10540 Samutprakarn - Phone: +66 2 738 96 20 - Fax: +66 2 738 96 29

<https://we-ef.com/asia>

Subject to technical changes and errors. - Generated on 23/11/2024

Mounting Accessories

Wall and pole brackets RE

Description	Part ID	C1	D1	D2	D × L1	H1	M1	Weight (kg)	C	H
Wall bracket RE0-540	111-0084	180	230	195			12	2.60	140	

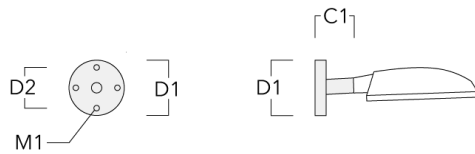

Pole bracket RE1-540, single	111-0042	200			76 x 130	550		7.30	200	550
------------------------------	----------	-----	--	--	----------	-----	--	------	-----	-----

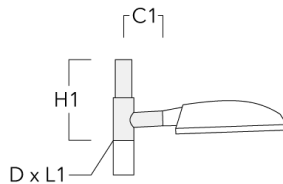

EFL540 LED

Pole mounted

Description	Part ID	C1	D1	D2	D × L1	H1	M1	Weight (kg)	C	H
Pole bracket RE2-540, double	111-0043	200			76 x 130	550		8.40	200	550

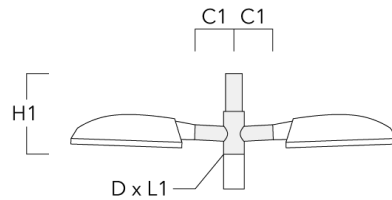

Wall and pole brackets RV

Description	Part ID	Additional information	C1	C2	C3	D1	D × L1	H1	H2	M1	M2	Weight (kg)	C	D	H
RV0 Wall bracket	108-0979-AP	RV0 Wall bracket	108	100	45			200	160	40	12	2.80	108		



EFL540 LED

Pole mounted

Description	Part ID	Additional information	C1	C2	C3	D1	D x L1	H1	H2	M1	M2	Weight (kg)	C	D	H
RV2-76 Pole bracket, double	108-0980	147					76 x 100					8.10	147	76	200

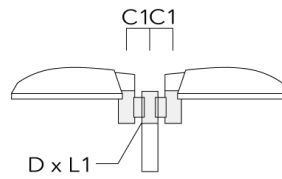

RV2-60 Pole bracket, double	108-0981	147					60 x 100					8.50	147	60	200
-----------------------------	----------	-----	--	--	--	--	----------	--	--	--	--	------	-----	----	-----

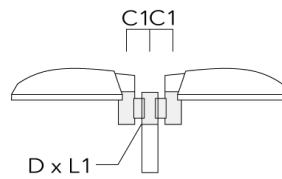

EFL540 LED

Pole mounted

Description	Part ID	Additional information	C1	C2	C3	D1	D × L1	H1	H2	M1	M2	Weight (kg)	C	D	H
RV5 Pole bracket	108-0982		108			76-240						2.30	106		200

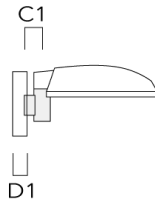

Pole brackets RF

Description	Part ID	C1	D × L1	H1	Weight (kg)	C	H
Pole bracket RF1-540, single	111-0046	200	76 x 80	200	5.60	200	300



EFL540 LED

Pole mounted

Description	Part ID	C1	D × L1	H1	Weight (kg)	C	H
Pole bracket RF2-540, double	111-0047	200	76 x 80	200	6.20	200	300



Tilt brackets TB

Description	Part ID	A	D1	D2	L	Weight (kg)
TB-540.60-10 Tilt bracket 10°	111-0636	10°	60 x 90	60 x 100	205	0.70



EFL540 LED

Pole mounted

Description	Part ID	A	D1	D2	L	Weight (kg)
TB-540.60-15 Tilt bracket 15°	111-0637	15°	60 x 90	60 x 100	205	0.70

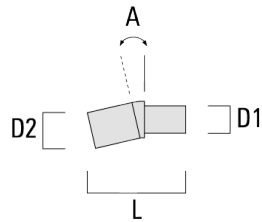

AKV

Description	Part ID	C1	D × L1	D × L2	H1	Weight (kg)
AKV2-76	300-0053	180	76x100	67x	235	1.50

