

PIA230 LED

Wall luminaires surface mounted

we-ef



WE-EF LEUCHTEN GmbH

Töpinger Straße 16, 29646 Bispingen, Germany - Phone: +49 5194 909-0
info@we-ef.com - <https://we-ef.com>

Subject to technical changes and errors. - Generated on 23/11/2024

PIA230 LED

Wall luminaires surface mounted

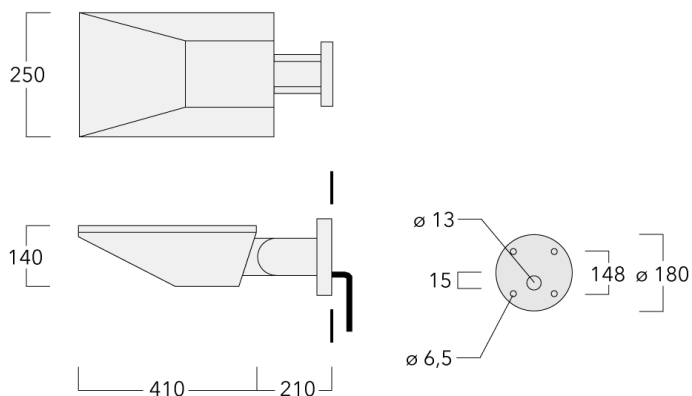





Description

IP66, Class I. Class II on request. IK08. Marine-grade, die-cast aluminium alloy. 5CE superior corrosion protection including PCS hardware. Silicone CCG® Controlled Compression Gasket. Safety glass, hinged. Integral EC electronic converter. CAD-optimised optics for superior illumination and glare control. OLC® One LED Concept. Factory installed LED circuit board. Luminaire +/-30° tiltable.

Optional 2200 K version available. To be specified at time of ordering.

Specifications

Material description

Body	Marine-grade die-cast aluminium alloy
Lens	Safety glass lens, hinged
Colours	 RAL9004 Signal black  RAL9006 White aluminium  RAL9007 Grey aluminium  RAL7016 Anthracite grey  RAL9016 Traffic white
Gasket	Silicone CCG® Controlled Compression Gasket
Fasteners	PCS Polymer Coated Stainless Steel Hardware
Ingress protection	IP66
Impact resistance	IK08
Corrosion resistance	5CE

Electrical description

Power supply	220-240V / 50-60 Hz
Driver / Ballast	Integral EC electronic converter

Additional information

Lifetime	Ta=25° L90B10 > 90000h
Energy efficiency class	C-D (Light source)

PIA230 LED

Wall luminaires surface mounted

Options

Light distribution



asymmetric, side throw beam [S65]



rectangular, side throw [R65]



asymmetric, forward throw [A60]

Colour temperature



3000 K



4000 K



2700 K

Nominal Watt

0 W

Configurations

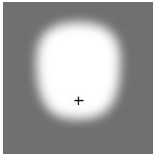
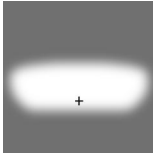
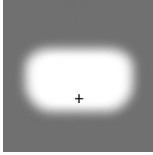
Light distribution	Part ID	Light source	Rated lumens	Rated input power	CRI	Weight (kg)
asymmetric, forward throw [A60] 	108-1666	LED-12/24W / 700 mA - 3000 K	2606.4	27 W	80	8.50
	108-1667	LED-12/24W / 700 mA - 4000 K	2786.2	27 W	80	8.50
	108-1751	LED-18/36W / 700 mA - 3000 K	3909.6	41 W	80	8.50
	108-1752	LED-18/36W / 700 mA - 4000 K	4179.3	41 W	80	8.50
	108-2537	LED-12/24W / 700 mA - 2700 K	2426.7	27 W	80	8.50
	108-2538	LED-18/36W / 700 mA - 2700 K	3640	41 W	80	8.50
asymmetric, side throw beam [S65] 	108-1660	LED-12/24W / 700 mA - 3000 K	2780.3	27 W	80	8.50
	108-1661	LED-12/24W / 700 mA - 4000 K	2972.1	27 W	80	8.50
	108-1747	LED-18/36W / 700 mA - 3000 K	4170.5	41 W	80	8.50
	108-1748	LED-18/36W / 700 mA - 4000 K	4458.1	41 W	80	8.50
	108-2535	LED-12/24W / 700 mA - 2700 K	2588.6	27 W	80	8.50
	108-2536	LED-18/36W / 700 mA - 2700 K	3882.9	41 W	80	8.50
rectangular, side throw [R65] 	108-1664	LED-12/24W / 700 mA - 3000 K	2434.4	27 W	80	8.50
	108-1665	LED-12/24W / 700 mA - 4000 K	2602.3	27 W	80	8.50
	108-1749	LED-18/36W / 700 mA - 3000 K	3651.7	41 W	80	8.50
	108-1750	LED-18/36W / 700 mA - 4000 K	3903.5	41 W	80	8.50
	108-2539	LED-12/24W / 700 mA - 2700 K	2266.5	27 W	80	8.50
	108-2540	LED-18/36W / 700 mA - 2700 K	3399.8	41 W	80	8.50