

PIA240 LED

Wall luminaires surface mounted

we-ef



Fagerhult Lighting Ltd

33-34 Dolben Street, SE1 0UQ London, United Kingdom

<https://we-ef.com/uk>

Subject to technical changes and errors. - Generated on 23/11/2024

PIA240 LED

Wall luminaires surface mounted

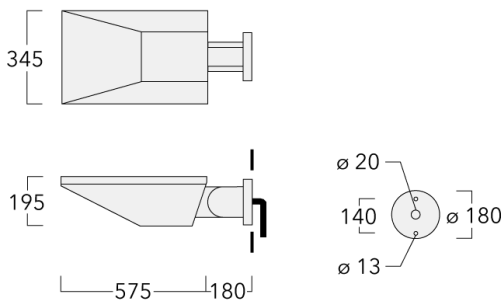





Description

IP66, Class I. Class II on request. IK08. Marine-grade, die-cast aluminium alloy. 5CE superior corrosion protection including PCS hardware. Silicone CCG® Controlled Compression Gasket. Safety glass, hinged. Integral EC electronic converter. CAD-optimised optics for superior illumination and glare control. OLC® One LED Concept. Factory installed LED circuit board. Luminaire +15°/-30° tiltable.

Optional 2200 K version available. To be specified at time of ordering.

Specifications**Material description**

Body	Marine-grade die-cast aluminium alloy
Lens	Safety glass lens, hinged
Colours	 RAL9004 Signal black  RAL9006 White aluminium  RAL9007 Grey aluminium  RAL7016 Anthracite grey  RAL9016 Traffic white
Gasket	Silicone CCG® Controlled Compression Gasket
Fasteners	PCS Polymer Coated Stainless Steel Hardware
Ingress protection	IP66
Impact resistance	IK08
Corrosion resistance	5CE

Electrical description

Power supply	220-240V / 50-60 Hz
Driver / Ballast	Integral EC electronic converter

Additional information

Lifetime	Ta=25° L90B10 > 90000h
Energy efficiency class	C-D (Light source)

PIA240 LED

Wall luminaires surface mounted

Options

Light distribution



asymmetric, side throw beam [S65]



rectangular, side throw [R65]



asymmetric, forward throw [A60]

Colour temperature



3000 K



4000 K



2700 K

Nominal Watt

0 W

Configurations

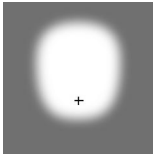
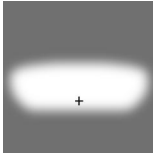
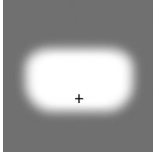
Light distribution	Part ID	Light source	Rated lumens	Rated input power	CRI	Weight (kg)
asymmetric, forward throw [A60] 	108-1655	LED-18/54W / 1050 mA - 3000 K	5782.2	59 W	80	12.70
	108-1656	LED-18/54W / 1050 mA - 4000 K	6051.1	59 W	80	12.70
	108-1763	LED-24/72W / 1050 mA - 3000 K	7709.6	81 W	80	12.70
	108-1764	LED-24/72W / 1050 mA - 4000 K	8068.2	81 W	80	12.70
	108-2543	LED-18/54W / 1050 mA - 2700 K	5513.2	59 W	80	12.70
	108-2544	LED-24/72W / 1050 mA - 2700 K	7351	81 W	80	12.70
asymmetric, side throw beam [S65] 	108-1649	LED-18/54W / 1050 mA - 3000 K	6202.2	59 W	80	12.70
	108-1650	LED-18/54W / 1050 mA - 4000 K	6490.7	59 W	80	12.70
	108-1759	LED-24/72W / 1050 mA - 3000 K	8269.6	81 W	80	12.70
	108-1760	LED-24/72W / 1050 mA - 4000 K	8654.2	81 W	80	12.70
	108-2541	LED-18/54W / 1050 mA - 2700 K	5913.7	59 W	80	12.70
	108-2542	LED-24/72W / 1050 mA - 2700 K	7885	81 W	80	12.70
rectangular, side throw [R65] 	108-1653	LED-18/54W / 1050 mA - 3000 K	6004.1	59 W	80	12.70
	108-1654	LED-18/54W / 1050 mA - 4000 K	6283.3	59 W	80	12.70
	108-1761	LED-24/72W / 1050 mA - 3000 K	8005.4	81 W	80	12.70
	108-1762	LED-24/72W / 1050 mA - 4000 K	8377.8	81 W	80	12.70
	108-2545	LED-18/54W / 1050 mA - 2700 K	5724.8	59 W	80	12.70
	108-2546	LED-24/72W / 1050 mA - 2700 K	7633.1	81 W	80	12.70