



**Description**

IP66, Class I. Class II on request. IK10. Marine-grade, all aluminium construction. 5CE superior corrosion protection including PCS hardware. Silicone CCG® Controlled Compression Gasket. Satinised safety glass lens. Integral EC electronic converter in thermally-separated compartment. CAD-optimised indirect optics for superior illumination and glare control. Factory installed LED circuit board. Pre-wired post complete with cable connecting box and fuse for mains connection.

Optional 2200 K version available. To be specified at time of ordering.

Optional Eco Step Dim® Motion version available. To be specified at time of ordering.

Bollards and pathway luminaires**Specifications****Material description**

Body	Marine-grade, all-aluminium construction
Lens	Satinised safety glass
Colours	 RAL9004 Signal black  RAL9006 White aluminium  RAL9007 Grey aluminium  RAL7016 Anthracite grey  RAL9016 Traffic white
Gasket	Silicone CCG® Controlled Compression Gasket
Fasteners	PCS Polymer Coated Stainless Steel Hardware
Ingress protection	IP66
Impact resistance	IK10
Corrosion resistance	5CE

Electrical description

Power supply	220-240V / 50-60 Hz
Driver / Ballast	Standard. Optional DALI version available. To be specified at time of ordering.
Surge protection	10/10kV (SP10)

Additional information

Lifetime	Ta=25° L90B10 > 90000h
Energy efficiency class	D (Light source)

CFY259 LED

Bollards and pathway luminaires

Options

Light distribution



asymmetric, forward-throw, one-sided



asymmetric, forward-throw, two-sided

Colour temperature



3000 K



4000 K



2700 K

Nominal Watt

0 W

Configurations

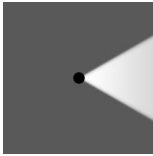
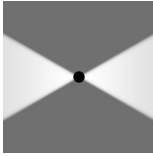
Light distribution	Part ID	Light source	Rated lumens	Rated input power	CRI	Weight (kg)
asymmetric, forward-throw, one-sided 	117-0211	LED-6/12W / 700 mA - 3000 K	368.3	14.5 W	80	15.00
	117-0212	LED-6/12W / 700 mA - 4000 K	393.7	14.5 W	80	15.00
	117-0213	LED-6/18W / 1050 mA - 3000 K	546.1	21 W	80	15.00
	117-0214	LED-6/18W / 1050 mA - 4000 K	571.5	21 W	80	15.00
	117-0328	LED-6/12W / 700 mA - 2700 K	342.9	14.5 W	80	15.00
	117-0329	LED-6/18W / 1050 mA - 2700 K	520.7	21 W	80	15.00
asymmetric, forward-throw, two-sided 	117-0273	LED-2x6/24W / 700 mA - 3000 K	736.6	27 W	80	15.00
	117-0274	LED-2x6/24W / 700 mA - 4000 K	787.4	27 W	80	15.00
	117-0275	LED-2x6/36W / 1050 mA - 3000 K	1092.3	41 W	80	15.00
	117-0276	LED-2x6/36W / 1050 mA - 4000 K	1143.1	41 W	80	15.00
	117-0330	LED-2x6/24W / 700 mA - 2700 K	685.8	27 W	80	15.00
	117-0331	LED-2x6/36W / 1050 mA - 2700 K	1041.5	41 W	80	15.00

Mounting Accessories

Planted root

Description	Part ID	D1	D2	D3	D4	H1	H2	M1	M2	Weight (kg)
Planted root ESV4	300-0464	220	190	102	108	400	350	8	6	4.30

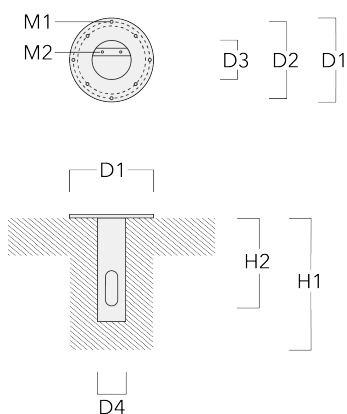

Control

Eco Step Dim® Motion

Description	Part ID
Eco Step Dim® Motion - Linked-Primary	430-0030

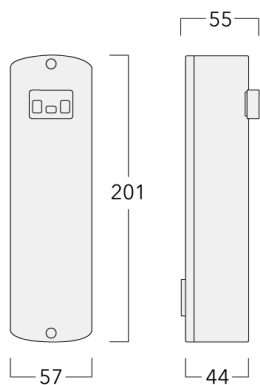

Eco Step Dim® Motion - Linked-Secondary	430-0031
---	----------

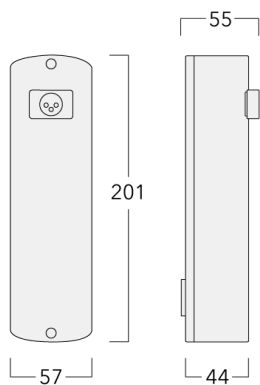

CFY259 LED

Bollards and pathway luminaires

Description	Part ID
Eco Step Dim® Motion - Stand-Alone	430-0037

