

**PFL240 LED**

**Pole mounted**

**we-ef**

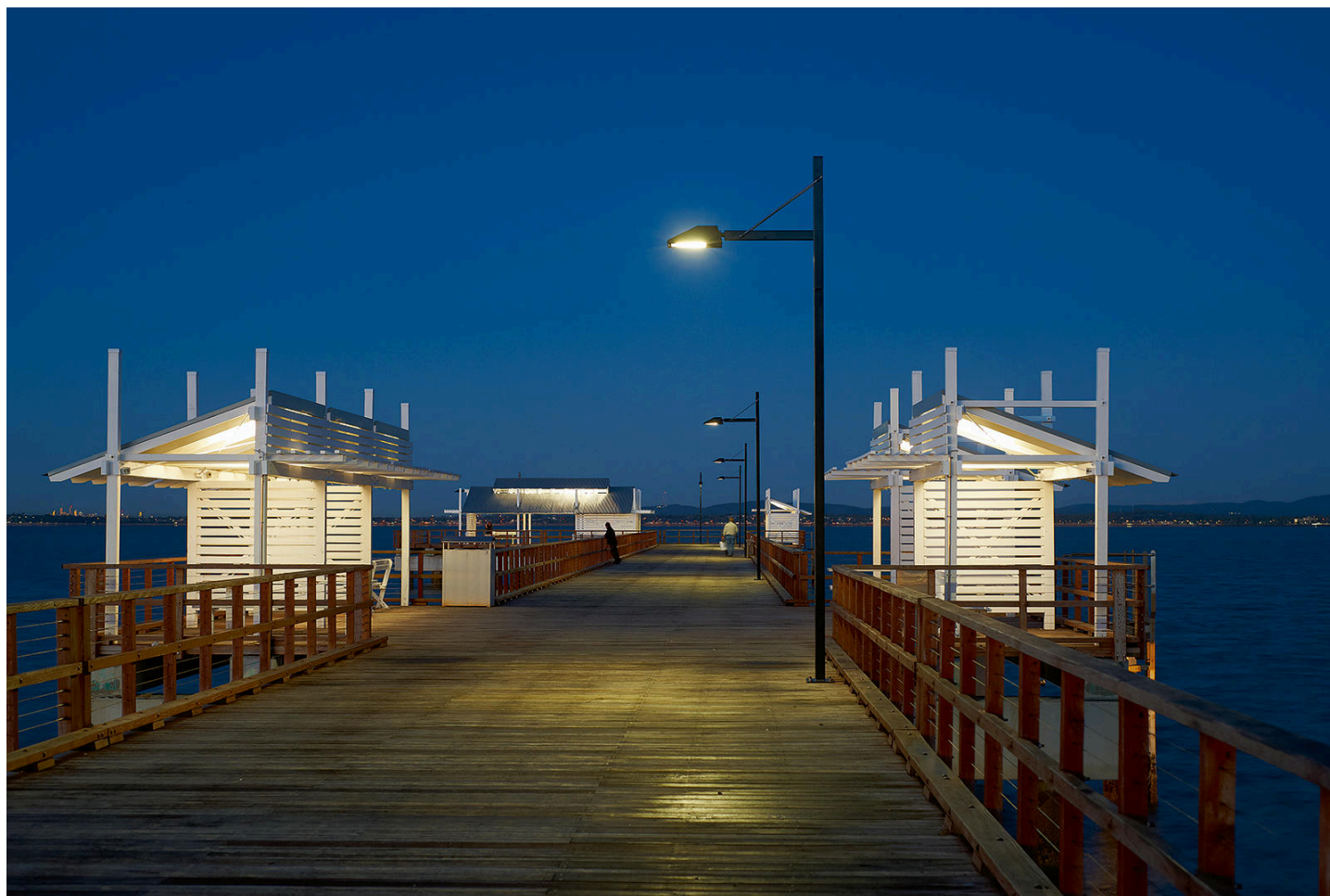

**Fagerhult Lighting Ltd**

33-34 Dolben Street, SE1 0UQ London, United Kingdom

<https://we-ef.com/uk>

Subject to technical changes and errors. - Generated on 23/11/2024

# PFL240 LED

Pole mounted

**we-ef**

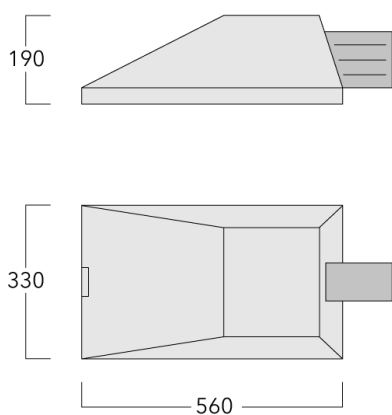

## Description

IP66, Class I. Class II on request. IK08. Marine-grade die-cast aluminium alloy. 5CE superior corrosion protection including PCS hardware. Silicone CCG® Controlled Compression Gasket. Safety glass lens, hinged. PMMA OLC® optics for superior illumination and glare control.

Optional 2200 K version up to max. 1050mA available. To be specified at time of ordering.

Brackets to be ordered separately.

## Fagerhult Lighting Ltd





33-34 Dolben Street, SE1 0UQ London, United Kingdom

<https://we-ef.com/uk>

Subject to technical changes and errors. - Generated on 23/11/2024

**Specifications****Material description**

---

Body	Marine-grade, die-cast aluminium alloy
Lens	Safety glass lens, hinged
Colours	 RAL9004 Signal black  RAL9006 White aluminium  RAL9007 Grey aluminium  RAL7016 Anthracite grey  RAL9016 Traffic white
Gasket	Silicone CCG® Controlled Compression Gasket
Fasteners	PCS Polymer Coated Stainless Steel Hardware
Ingress protection	IP66
Impact resistance	IK08
Corrosion resistance	5CE
Windage	0.075 m <sup>2</sup>

---

**Electrical description**

---

Power supply	220-240V / 50-60 Hz
Driver / Ballast	Integral EC electronic converter. DALI
Power factor	> 0.9
Surge protection	6/6 kV (optional SP10)

---

**Additional information**

---

Lifetime	Ta=25° L90B10 > 90000h
Energy efficiency class	C-D (Light source)

---

# PFL240 LED

Pole mounted

**we-ef**

## Options

### Light distribution



asymmetric, side throw beam [S65]



rectangular, side throw [R65]



asymmetric, forward throw [A60]



pedestrian crossing, left-hand traffic [P45L]



pedestrian crossing, right-hand traffic [P45R]

### Colour temperature



3000 K



4000 K



2700 K

### Nominal Watt

43 W

55 W

59 W

83 W

54 W

## Configurations

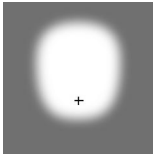
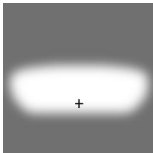
Light distribution	Part ID	Light source	Rated lumens	Rated input power	CRI	Weight (kg)
asymmetric, forward throw [A60] 	108-1638	LED-24/72W / 1050 mA - 3000 K	7709.3	81 W	80	13.50
	108-1638-70	LED-24/72W / 1050 mA - 3000 K	8785	81 W	70	13.50
	108-1643	LED-24/72W / 1050 mA - 4000 K	8067.9	81 W	80	13.50
	108-1643-70	LED-24/72W / 1050 mA - 4000 K	9143.6	81 W	70	13.50
	108-1681	LED-24/48W / 700 mA - 3000 K	5199.3	54 W	80	13.50
	108-1681-70	LED-24/48W / 700 mA - 3000 K	5916.4	54 W	70	13.50
	108-1682	LED-24/48W / 700 mA - 4000 K	5557.9	54 W	80	13.50
	108-1682-70	LED-24/48W / 700 mA - 4000 K	6275	54 W	70	13.50
	108-1691	LED-18/54W / 1050 mA - 3000 K	5782	59 W	80	13.50
	108-1691-70	LED-18/54W / 1050 mA - 3000 K	6588.8	59 W	70	13.50
	108-1692	LED-18/54W / 1050 mA - 4000 K	6050.9	59 W	80	13.50
	108-1692-70	LED-18/54W / 1050 mA - 4000 K	6857.7	59 W	70	13.50
	108-1703	LED-18/36W / 700 mA - 3000 K	3899.5	41 W	80	13.50
	108-1703-70	LED-18/36W / 700 mA - 3000 K	4437.3	41 W	70	13.50
	108-1704	LED-18/36W / 700 mA - 4000 K	4168.4	41 W	80	13.50
	108-1704-70	LED-18/36W / 700 mA - 4000 K	4706.3	41 W	70	13.50
	108-2512	LED-18/36W / 700 mA - 2700 K	3630.5	41 W	80	13.50
	108-2512-70	LED-18/36W / 700 mA - 2700 K	3899.5	41 W	70	13.50
	108-2513	LED-18/54W / 1050 mA - 2700 K	5513	59 W	80	13.50
	108-2513-70	LED-18/54W / 1050 mA - 2700 K	6319.8	59 W	70	13.50
108-2514	LED-24/48W / 700 mA - 2700 K	4840.7	54 W	80	13.50	
108-2514-70	LED-24/48W / 700 mA - 2700 K	5199.3	54 W	70	13.50	
108-2515	LED-24/72W / 1050 mA - 2700 K	7350.7	81 W	80	13.50	
108-2515-70	LED-24/72W / 1050 mA - 2700 K	8426.4	81 W	70	13.50	
asymmetric, side throw beam [S65] 	108-1635	LED-24/72W / 1050 mA - 3000 K	8269.3	81 W	80	13.50
	108-1635-70	LED-24/72W / 1050 mA - 3000 K	9423.2	81 W	70	13.50
	108-1641	LED-24/72W / 1050 mA - 4000 K	8654	81 W	80	13.50
	108-1641-70	LED-24/72W / 1050 mA - 4000 K	9807.8	81 W	70	13.50
	108-1677	LED-24/48W / 700 mA - 3000 K	5577	54 W	80	13.50
	108-1677-70	LED-24/48W / 700 mA - 3000 K	6346.2	54 W	70	13.50
	108-1678	LED-24/48W / 700 mA - 4000 K	5961.6	54 W	80	13.50
	108-1678-70	LED-24/48W / 700 mA - 4000 K	6730.9	54 W	70	13.50
	108-1687	LED-18/54W / 1050 mA - 3000 K	6202	59 W	80	13.50
	108-1687-70	LED-18/54W / 1050 mA - 3000 K	7067.4	59 W	70	13.50
	108-1688	LED-18/54W / 1050 mA - 4000 K	6490.5	59 W	80	13.50

# PFL240 LED

## Pole mounted

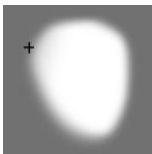
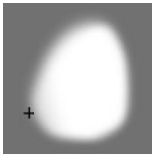
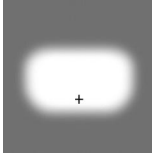
Light distribution	Part ID	Light source	Rated lumens	Rated input power	CRI	Weight (kg)
	108-1688-70	LED-18/54W / 1050 mA - 4000 K	7355.9	59 W	70	13.50
	108-1699	LED-18/36W / 700 mA - 3000 K	4182.7	41 W	80	13.50
	108-1699-70	LED-18/36W / 700 mA - 3000 K	4759.7	41 W	70	13.50
	108-1700	LED-18/36W / 700 mA - 4000 K	4471.2	41 W	80	13.50
	108-1700-70	LED-18/36W / 700 mA - 4000 K	5048.1	41 W	70	13.50
	108-2504	LED-18/36W / 700 mA - 2700 K	3894.3	41 W	80	13.50
	108-2504-70	LED-18/36W / 700 mA - 2700 K	4182.7	41 W	70	13.50
	108-2505	LED-18/54W / 1050 mA - 2700 K	5913.5	59 W	80	13.50
	108-2505-70	LED-18/54W / 1050 mA - 2700 K	6778.9	59 W	70	13.50
	108-2506	LED-24/48W / 700 mA - 2700 K	5192.4	54 W	80	13.50
	108-2506-70	LED-24/48W / 700 mA - 2700 K	5577	54 W	70	13.50
	108-2507	LED-24/72W / 1050 mA - 2700 K	7884.7	81 W	80	13.50
	108-2507-70	LED-24/72W / 1050 mA - 2700 K	9038.6	81 W	70	13.50
pedestrian crossing, left-hand traffic [P45L] 	108-1979	LED-24/72W / 1050 mA - 3000 K	8027.2	81 W	80	13.50
	108-1979-70	LED-24/72W / 1050 mA - 3000 K	9147.3	81 W	70	13.50
	108-1980	LED-24/72W / 1050 mA - 4000 K	8400.5	81 W	80	13.50
	108-1980-70	LED-24/72W / 1050 mA - 4000 K	9520.6	81 W	70	13.50
pedestrian crossing, right-hand traffic [P45R] 	108-2516	LED-24/72W / 1050 mA - 2700 K	7617.3	81 W	80	13.50
	108-2516-70	LED-24/72W / 1050 mA - 2700 K	8732	81 W	70	13.50
rectangular, side throw [R65] 	108-1634	LED-24/72W / 1050 mA - 3000 K	7533.8	81 W	80	13.50
	108-1634-70	LED-24/72W / 1050 mA - 3000 K	8585	81 W	70	13.50
	108-1639	LED-24/72W / 1050 mA - 4000 K	7884.2	81 W	80	13.50
	108-1639-70	LED-24/72W / 1050 mA - 4000 K	8935.4	81 W	70	13.50
	108-1679	LED-24/48W / 700 mA - 3000 K	5080.9	54 W	80	13.50
	108-1679-70	LED-24/48W / 700 mA - 3000 K	5781.7	54 W	70	13.50
	108-1680	LED-24/48W / 700 mA - 4000 K	5431.3	54 W	80	13.50
	108-1680-70	LED-24/48W / 700 mA - 4000 K	6132.1	54 W	70	13.50
	108-1689	LED-18/54W / 1050 mA - 3000 K	5650.3	59 W	80	13.50
	108-1689-70	LED-18/54W / 1050 mA - 3000 K	6438.7	59 W	70	13.50
	108-1690	LED-18/54W / 1050 mA - 4000 K	5913.1	59 W	80	13.50
	108-1690-70	LED-18/54W / 1050 mA - 4000 K	6701.5	59 W	70	13.50

# PFL240 LED

## Pole mounted

Light distribution	Part ID	Light source	Rated lumens	Rated input power	CRI	Weight (kg)
	108-1701	LED-18/36W / 700 mA - 3000 K	3810.7	41 W	80	13.50
	108-1701-70	LED-18/36W / 700 mA - 3000 K	4336.3	41 W	70	13.50
	108-1702	LED-18/36W / 700 mA - 4000 K	4073.5	41 W	80	13.50
	108-1702-70	LED-18/36W / 700 mA - 4000 K	4599.1	41 W	70	13.50
	108-2508	LED-18/36W / 700 mA - 2700 K	3547.9	41 W	80	13.50
	108-2508-70	LED-18/36W / 700 mA - 2700 K	3810.7	41 W	70	13.50
	108-2509	LED-18/54W / 1050 mA - 2700 K	5387.5	59 W	80	13.50
	108-2509-70	LED-18/54W / 1050 mA - 2700 K	6175.9	59 W	70	13.50
	108-2510	LED-24/48W / 700 mA - 2700 K	4730.5	54 W	80	13.50
	108-2510-70	LED-24/48W / 700 mA - 2700 K	5080.9	54 W	70	13.50
	108-2511	LED-24/72W / 1050 mA - 2700 K	7183.4	81 W	80	13.50
	108-2511-70	LED-24/72W / 1050 mA - 2700 K	8234.6	81 W	70	13.50

# PFL240 LED

Pole mounted

## Control

### Eco Step Dim® Basic

Description	Part ID
Eco Step Dim® Basic LED	430-0001

### Eco Step Dim® Advanced

Description	Part ID
Eco Step Dim® Advanced LED	430-0002



**Mounting Accessories**

**Wall and pole brackets KI**

Description	Part ID	A	C1	D1	D2	H1	M1	Weight (kg)	Alpha	C	D	H
KI0-240/260 Wall bracket	108-0493	±30°	210	180	140		12	5.70	±3°	210	180	180

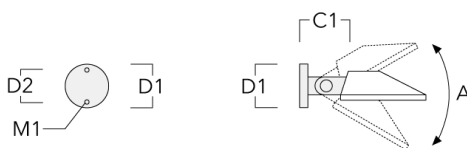

KI1-240 Pole bracket, single	108-0491	±30°	210			525		6.90	+15° / -30°	210		525
------------------------------	----------	------	-----	--	--	-----	--	------	-------------	-----	--	-----

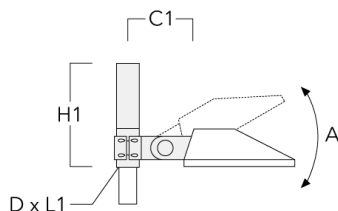

**Pole mounted**

Description	Part ID	A	C1	D1	D2	H1	M1	Weight (kg)	Alpha	C	D	H
KI2-240 Pole bracket, double	108-0492	±30°	210			525		8.60	+15° / -30°	210		525

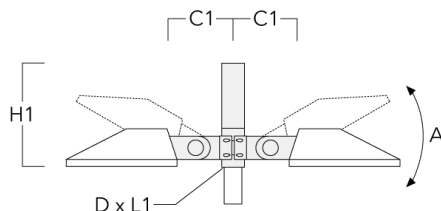

**Pole brackets KL**

Description	Part ID	C1	D x L1	H1	Weight (kg)	C	H
KL1-240 Pole bracket, single	108-0342	735	76 x 130	750	9	725	750

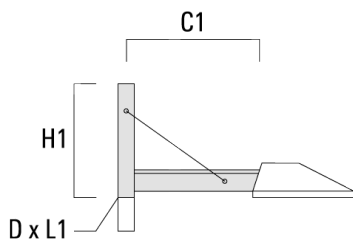

# PFL240 LED

## Pole mounted

Description	Part ID	C1	D × L1	H1	Weight (kg)	C	H
KL2-240 Pole bracket, double	108-0532	735	76 x 130	750	14	725	750

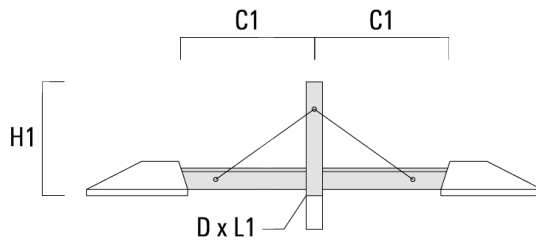

## Wall and pole brackets KP

Description	Part ID	C1	D1	D2	D × L1	H1	M1	Weight (kg)	C	D	H
KP0-240 Wall bracket	108-0103	200	230	195			12 2		175	230	230

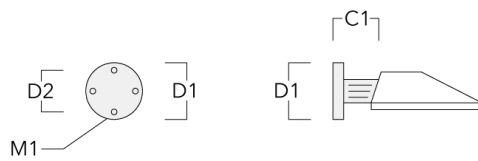

**Pole mounted**

Description	Part ID	C1	D1	D2	D x L1	H1	M1	Weight (kg)	C	D	H
KP1-240 Pole bracket, single	108-0104	215			76 x 80	575		3.80	175		575

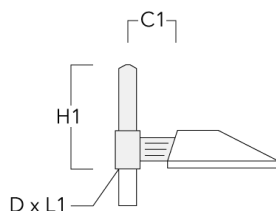

KP2-240 Pole bracket, double	108-0105	215			76 x 80	575		3.80	175		575
------------------------------	----------	-----	--	--	---------	-----	--	------	-----	--	-----

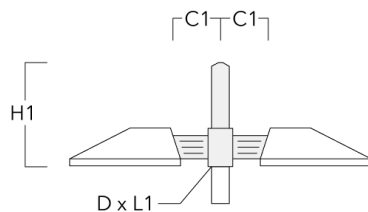

**Pole brackets KP\_L**

Description	Part ID	C1	D x L1	H1	Weight (kg)	C	H
KP1-L-240 Pole bracket, single	108-0268	635	76 x 130	575	9.10	175	575

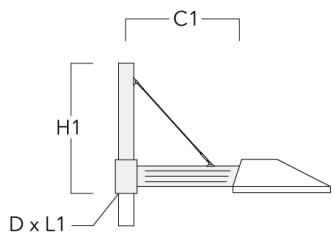

KP2-L-240 Pole bracket, double	108-0373	635	76 x 130	575	15	175	575
--------------------------------	----------	-----	----------	-----	----	-----	-----

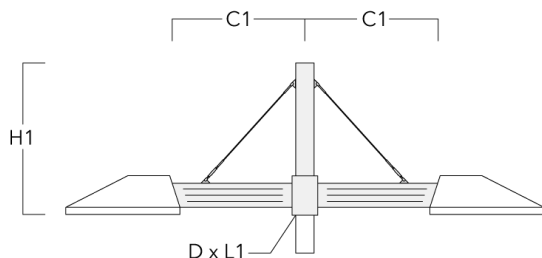

**Pole brackets KX**

Description	Part ID	C1	D x L1	H1	Weight (kg)	C	H
KX1-240 Pole bracket, single	108-0343	735	76 x 130	410	7	725	410

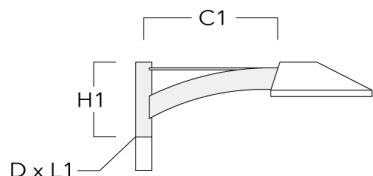

KX2-240 Pole bracket, double	108-0534	735	76 x 130	410	11	725	410
------------------------------	----------	-----	----------	-----	----	-----	-----

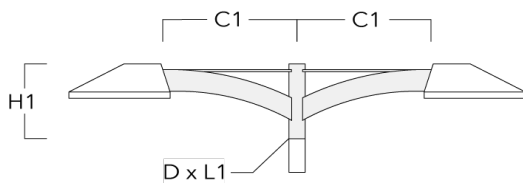

**Pole brackets KY**

Description	Part ID	A	C1	D x L1	H1	Weight (kg)	Alpha	C	H
KY1-240 Pole bracket, single	108-0500	±30°	210	76 x 80	930	9.90	+15° / -30°	210	575

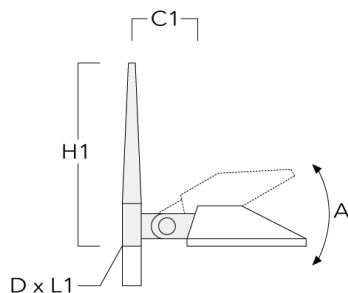

KY2-240 Pole bracket, double	108-0501	±30°	210	76 x 80	730	12.80	+15° / -30°	210	575
------------------------------	----------	------	-----	---------	-----	-------	-------------	-----	-----

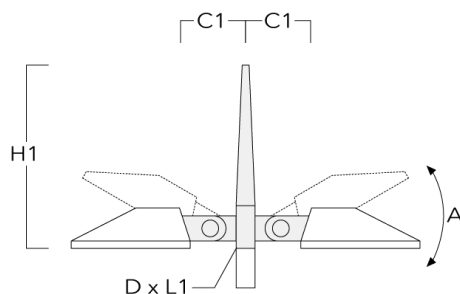

**Pole clamp SI**

Description	Part ID	C1	D1	Weight (kg)	C
SI1-240/260 Pole clamp, single (Ø 76-89)	108-0482	210	76-89	3.60	210

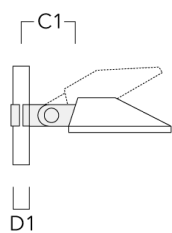

SI1-240/260 Pole clamp, single (Ø 114-133)	108-0483	210	114-133	4.40	210
--------------------------------------------	----------	-----	---------	------	-----

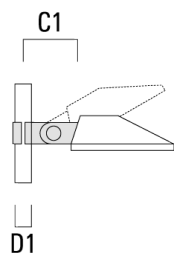



**Pole mounted**

Description	Part ID	C1	D1	Weight (kg)	C
SI1-240/260 Pole clamp, single (Ø 102-114)	108-0781	210	102-114	4	210

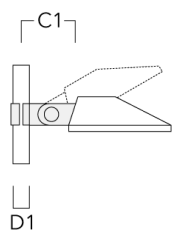

SI2-240/260 Pole clamp, double (Ø 76-89)	108-0484	210	76-89	5.20	210
------------------------------------------	----------	-----	-------	------	-----

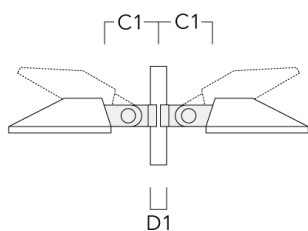

**Pole mounted**

Description	Part ID	C1	D1	Weight (kg)	C
SI2-240/260 Pole clamp, double (Ø 114-133)	108-0485	210	114-133	6.20	210

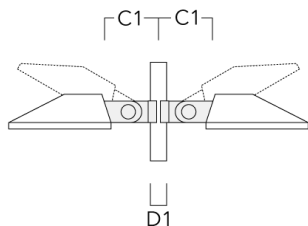

SI2-240/260 Pole clamp, double (Ø 102-114)	108-0783	210	102-114	5.70	210
--------------------------------------------	----------	-----	---------	------	-----

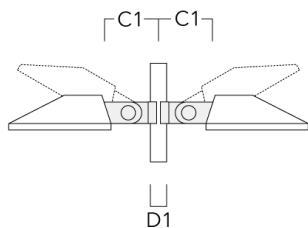

**Pole clamp SK**

Description	Part ID	C1	D1	Weight (kg)	C
SK1-240 Pole clamp, single (Ø 102-114)	108-0782	175	102-114	3.40	175

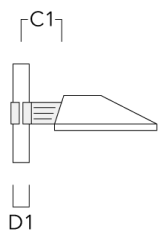

SK1-240 Pole clamp, single (Ø 76-89)	108-0788	175	76-89	3	175
--------------------------------------	----------	-----	-------	---	-----

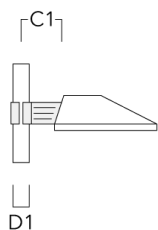

**Pole mounted**

Description	Part ID	C1	D1	Weight (kg)	C
SK1-240 Pole clamp, single (Ø 114-133)	108-0789	175	114-133	3.80	175

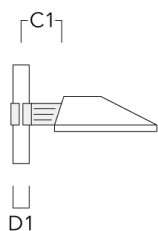

SK2-240 Pole clamp, double (Ø 102-114)	108-0784	175	102-114	4.30	175
----------------------------------------	----------	-----	---------	------	-----

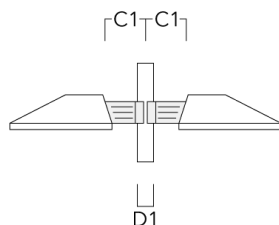

**Pole mounted**

Description	Part ID	C1	D1	Weight (kg)	C
SK2-240 Pole clamp, double (Ø 76-89)	108-0790	175	76-89	3.90	175

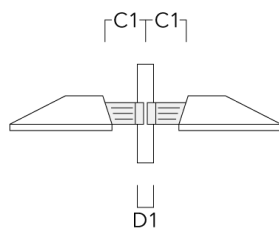

SK2-240 Pole clamp, double (Ø 114-133)	108-0791	175	114-133	4.70	175
----------------------------------------	----------	-----	---------	------	-----

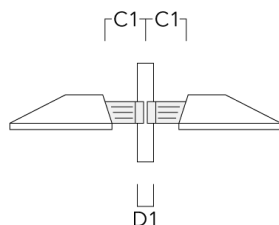

**Optical Accessories****Light shield**

Description	Part ID	Additional information
LS180-[A60]	430-0038	Light shield LS180 to greatly reduce or eliminate light pollution. PA injection moulded component, black matt. Suitable for asymmetric light distribution [A60].
LS180	430-0029	Glare Shield for backlight spill. Glare Shield factory-installed or available as retrofit kit. Suitable for [S60], [S65], [S70], [R65], [P65] lenses. Must be specified at time of ordering.