

PFL240 LED

Pole mounted

we-ef

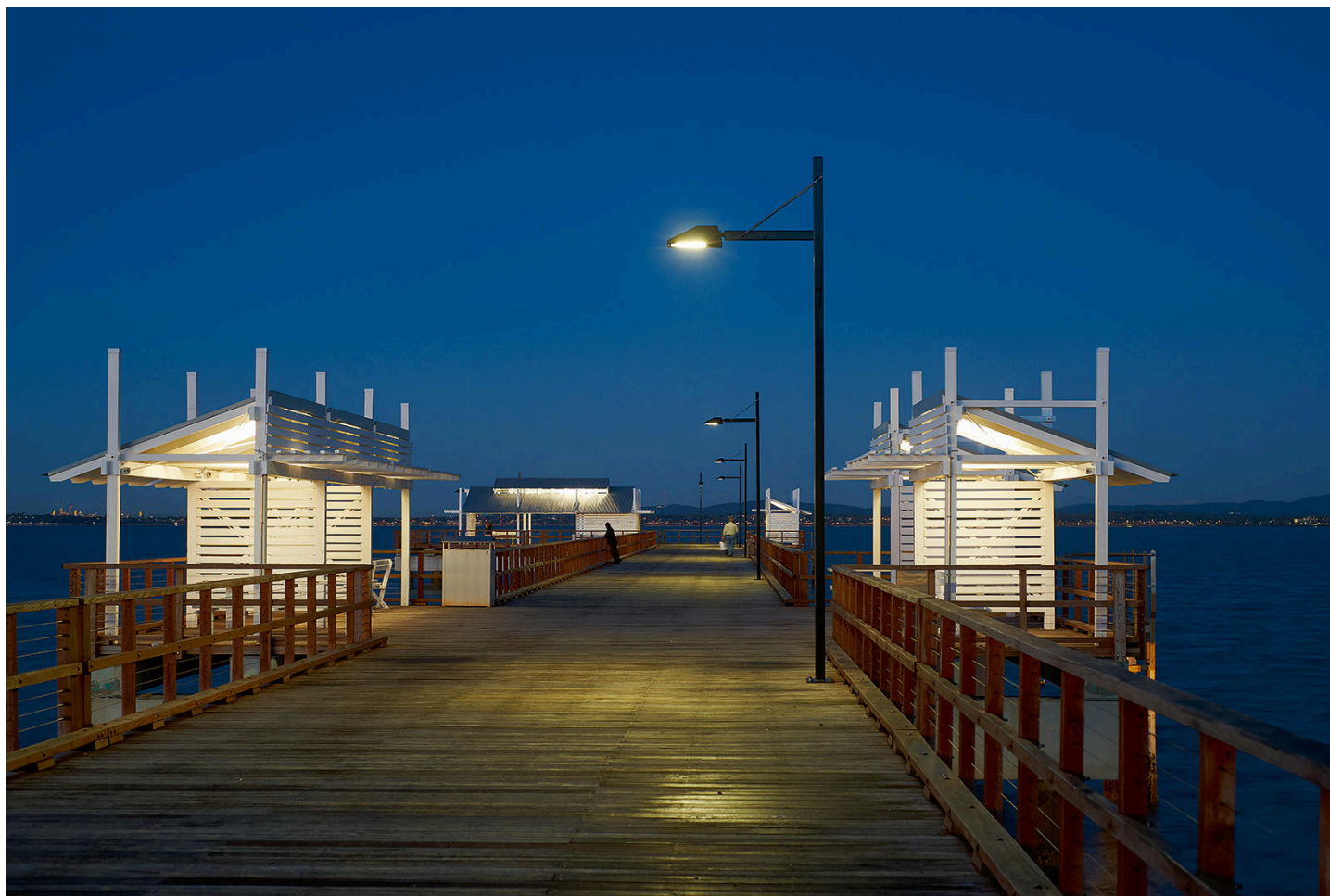

WE-EF LIGHTING (Thailand) Co., Ltd.

57 Moo 5, Kingkaew Rd., Bangplee, 10540 Samutprakarn - Phone: +66 2 738 96 20 - Fax: +66 2 738 96 29

<https://we-ef.com/asia>

Subject to technical changes and errors. - Generated on 23/11/2024

PFL240 LED

Pole mounted

we-ef

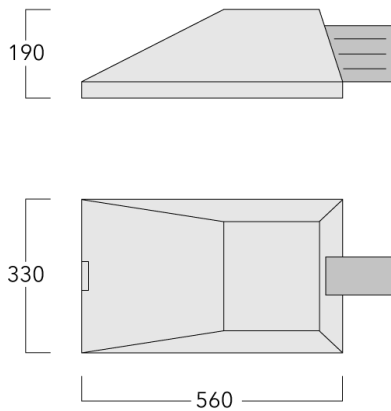

Description

IP66. IK08. Marine-grade, die-cast aluminium alloy. 5CE superior corrosion protection including PCS hardware. Safety glass lens, hinged. Silicone CCG® Controlled Compression Gasket.

Integral electronic converter with DALI interface. Advanced thermal management protects LEDs while optimising lumens output. Removable LED boards for upgrading. CAD-optimised optics for superior illumination and glare control. OLC® One LED Concept. Optional 2200 K version up to max. 1050mA available. To be specified at time of ordering.

Including 0.5 m cable with a cable connector.

Maximum spacing for streetlighting applications depends on wattage and light distribution: 5.5 to 9 times the mounting height.

WE-EF LIGHTING (Thailand) Co., Ltd.

57 Moo 5, Kingkaew Rd., Bangplee, 10540 Samutprakarn - Phone: +66 2 738 96 20 - Fax: +66 2 738 96 29

<https://we-ef.com/asia>

Subject to technical changes and errors. - Generated on 23/11/2024





PFL240 LED

Pole mounted

we-ef

Specifications

Material description

Body	Marine-grade, die-cast aluminium alloy
Lens	Safety glass lens, hinged
Colours	 RAL9004 Signal black  RAL9007 Grey aluminium  RAL7016 Anthracite grey  RAL9016 Traffic white
Gasket	Silicone CCG® Controlled Compression Gasket
Fasteners	PCS Polymer Coated Stainless Steel Hardware
Ingress protection	IP66
Impact resistance	IK08
Corrosion resistance	5CE
Windage	0.075 m ²

Electrical description

Power supply	220-240V / 50-60 Hz
Driver / Ballast	Integral electronic converter with DALI interface
Power factor	> 0.9

Additional information

Lifetime	Ta=25° L90B10 > 90000h
BUG Rating	Please see individual Spec Sheets for classification of Backlight, Uplight and Glare

WE-EF LIGHTING (Thailand) Co., Ltd.

57 Moo 5, Kingkaew Rd., Bangplee, 10540 Samutprakarn - Phone: +66 2 738 96 20 - Fax: +66 2 738 96 29

<https://we-ef.com/asia>

Subject to technical changes and errors. - Generated on 23/11/2024

PFL240 LED

Pole mounted

we-ef

Options

Light distribution



asymmetric, side throw [S65]



rectangular, side throw [R65]



asymmetric, forward throw [A60]



pedestrian crossing, left-hand traffic [P45L]



pedestrian crossing, right-hand traffic [P45R]

Colour temperature



3000 K



4000 K



2700 K

Nominal Watt

43 W

55 W

59 W

83 W

54 W

Configurations

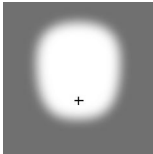
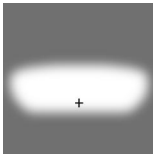
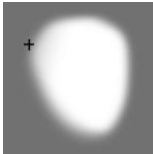
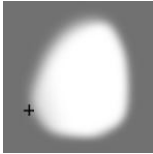
Light distribution	Part ID	Light source	Rated lumens	Rated input power	CRI	Weight (kg)
asymmetric, forward throw [A60] 	108-1638	LED-24/72W / 1050 mA - 3000 K	7709.3	81 W	80	13.50
	108-1643	LED-24/72W / 1050 mA - 4000 K	8067.9	81 W	80	13.50
	108-1681	LED-24/48W / 700 mA - 3000 K	5199.3	54 W	80	13.50
	108-1682	LED-24/48W / 700 mA - 4000 K	5557.9	54 W	80	13.50
	108-1691	LED-18/54W / 1050 mA - 3000 K	5782	59 W	80	13.50
	108-1692	LED-18/54W / 1050 mA - 4000 K	6050.9	59 W	80	13.50
	108-1703	LED-18/36W / 700 mA - 3000 K	3899.5	41 W	80	13.50
	108-1704	LED-18/36W / 700 mA - 4000 K	4168.4	41 W	80	13.50
	108-2512	LED-18/36W / 700 mA - 2700 K	3630.5	41 W	80	13.50
	108-2513	LED-18/54W / 1050 mA - 2700 K	5513	59 W	80	13.50
	108-2514	LED-24/48W / 700 mA - 2700 K	4840.7	54 W	80	13.50
	108-2515	LED-24/72W / 1050 mA - 2700 K	7350.7	81 W	80	13.50
	asymmetric, side throw [S65] 	108-1635	LED-24/72W / 1050 mA - 3000 K	8269.3	81 W	80
108-1641		LED-24/72W / 1050 mA - 4000 K	8654	81 W	80	13.50
108-1677		LED-24/48W / 700 mA - 3000 K	5577	54 W	80	13.50
108-1678		LED-24/48W / 700 mA - 4000 K	5961.6	54 W	80	13.50
108-1687		LED-18/54W / 1050 mA - 3000 K	6202	59 W	80	13.50
108-1688		LED-18/54W / 1050 mA - 4000 K	6490.5	59 W	80	13.50
108-1699		LED-18/36W / 700 mA - 3000 K	4182.7	41 W	80	13.50
108-1700		LED-18/36W / 700 mA - 4000 K	4471.2	41 W	80	13.50
108-2504		LED-18/36W / 700 mA - 2700 K	3894.3	41 W	80	13.50
108-2505		LED-18/54W / 1050 mA - 2700 K	5913.5	59 W	80	13.50
108-2506		LED-24/48W / 700 mA - 2700 K	5192.4	54 W	80	13.50
108-2507		LED-24/72W / 1050 mA - 2700 K	7884.7	81 W	80	13.50
pedestrian crossing, left-hand traffic [P45L] 		108-1979	LED-24/72W / 1050 mA - 3000 K	8027.2	81 W	80
	108-1980	LED-24/72W / 1050 mA - 4000 K	8400.5	81 W	80	13.50
pedestrian crossing, right-hand traffic [P45R] 	108-1981	LED-24/72W / 1050 mA - 3000 K	7988.9	81 W	80	13.50
	108-1982	LED-24/72W / 1050 mA - 4000 K	8360.5	81 W	80	13.50
	108-2516	LED-24/72W / 1050 mA - 2700 K	7617.3	81 W	80	13.50

PFL240 LED

Pole mounted

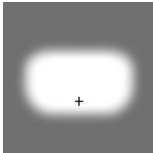
Light distribution	Part ID	Light source	Rated lumens	Rated input power	CRI	Weight (kg)
rectangular, side throw [R65] 	108-1634	LED-24/72W / 1050 mA - 3000 K	7533.8	81 W	80	13.50
	108-1639	LED-24/72W / 1050 mA - 4000 K	7884.2	81 W	80	13.50
	108-1679	LED-24/48W / 700 mA - 3000 K	5080.9	54 W	80	13.50
	108-1680	LED-24/48W / 700 mA - 4000 K	5431.3	54 W	80	13.50
	108-1689	LED-18/54W / 1050 mA - 3000 K	5650.3	59 W	80	13.50
	108-1690	LED-18/54W / 1050 mA - 4000 K	5913.1	59 W	80	13.50
	108-1701	LED-18/36W / 700 mA - 3000 K	3810.7	41 W	80	13.50
	108-1702	LED-18/36W / 700 mA - 4000 K	4073.5	41 W	80	13.50
	108-2508	LED-18/36W / 700 mA - 2700 K	3547.9	41 W	80	13.50
	108-2509	LED-18/54W / 1050 mA - 2700 K	5387.5	59 W	80	13.50
	108-2510	LED-24/48W / 700 mA - 2700 K	4730.5	54 W	80	13.50
	108-2511	LED-24/72W / 1050 mA - 2700 K	7183.4	81 W	80	13.50

Mounting Accessories

Wall and pole brackets KI

Description	Part ID	A	C1	D1	D2	H1	M1	Weight (kg)	Alpha	C	D	H
Wall bracket KI0-240/260	108-0493	±30°	210	180	140		12	5.70	±3°	210	180	180

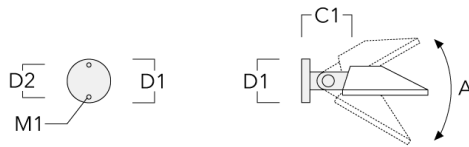

Pole bracket KI1-240, single	108-0491	±30°	210			525		6.90	+15° / -30°	210		525
------------------------------	----------	------	-----	--	--	-----	--	------	-------------	-----	--	-----

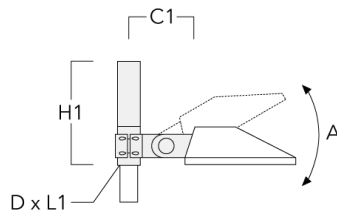

PFL240 LED

Pole mounted

Description	Part ID	A	C1	D1	D2	H1	M1	Weight (kg)	Alpha	C	D	H
Pole bracket KL2-240, double	108-0492	$\pm 30^\circ$	210			525		8.60	$+15^\circ / -30^\circ$	210		525

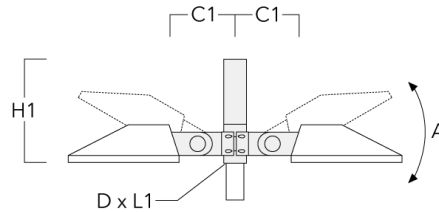

Pole brackets KL

Description	Part ID	C1	D x L1	H1	Weight (kg)	C	H
KL1-240 Pole bracket, single	108-0342	735	76 x 130	750	9	725	750

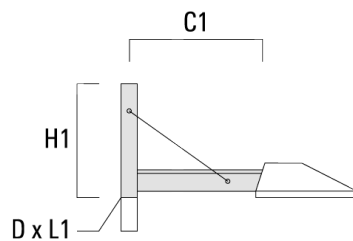

PFL240 LED

Pole mounted

Description	Part ID	C1	D × L1	H1	Weight (kg)	C	H
KL2-240 Pole bracket, double	108-0532	735	76 x 130	750	14	725	750

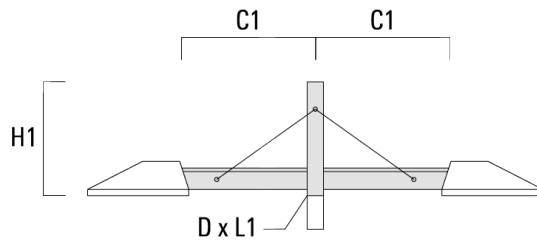

Wall and pole brackets KP

Description	Part ID	C1	D1	D2	D × L1	H1	M1	Weight (kg)	C	D	H
Wall bracket KP0-240	108-0103	200	230	195			12	2	175	230	230

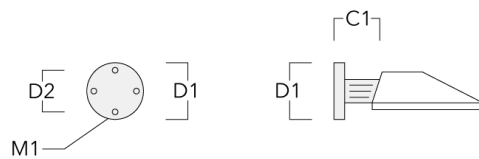

PFL240 LED

Pole mounted

Description	Part ID	C1	D1	D2	D x L1	H1	M1	Weight (kg)	C	D	H
Pole bracket KP1-240, single	108-0104	215			76 x 80	575		3.80	175		575

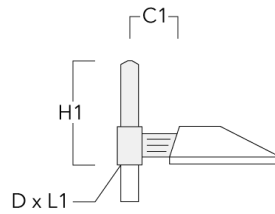

Pole bracket KP2-240, double	108-0105	215			76 x 80	575		3.80	175		575
------------------------------	----------	-----	--	--	---------	-----	--	------	-----	--	-----

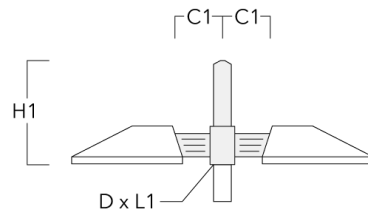

Pole brackets KP_L

Description	Part ID	C1	D x L1	H1	Weight (kg)	C	H
Pole bracket KP1-L-240, single	108-0268	635	76 x 130	575	9.10	175	575

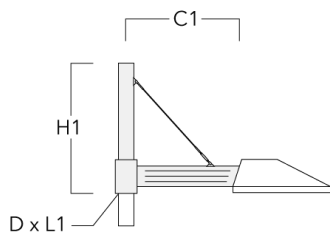

Pole bracket KP2-L-240, double	108-0373	635	76 x 130	575	15	175	575
--------------------------------	----------	-----	----------	-----	----	-----	-----

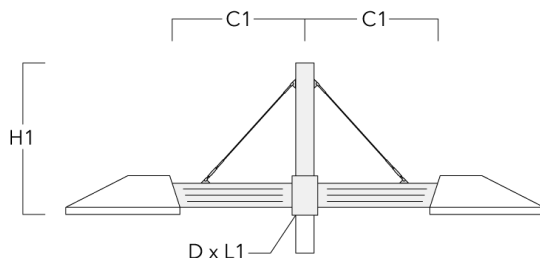

Pole brackets KX

Description	Part ID	C1	D × L1	H1	Weight (kg)	C	H
KX1-240 Pole bracket, single	108-0343	735	76 x 130	410	7	725	410

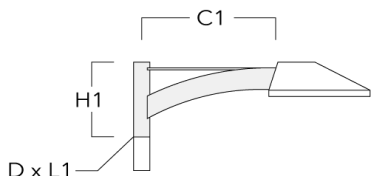

KX2-240 Pole bracket, double	108-0534	735	76 x 130	410	11	725	410
------------------------------	----------	-----	----------	-----	----	-----	-----

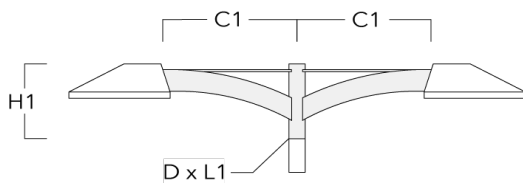

Pole brackets KY

Description	Part ID	A	C1	D x L1	H1	Weight (kg)	Alpha	C	H
KY1-240 Pole bracket, single	108-0500	±30°	210	76 x 80	930	9.90	+15° / -30°	210	575

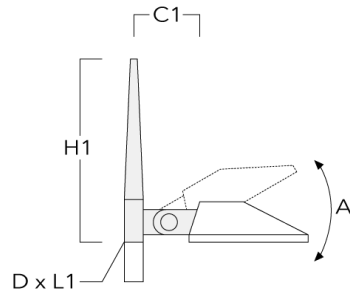

KY2-240 Pole bracket, double	108-0501	±30°	210	76 x 80	730	12.80	+15° / -30°	210	575
------------------------------	----------	------	-----	---------	-----	-------	-------------	-----	-----

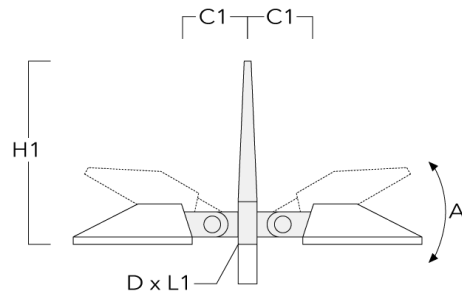

Pole clamp SI

Description	Part ID	C1	D1	Weight (kg)	C
Pole clamp SI1-240/260, single (Ø 76-89)	108-0482	210	76-89	3.60	210

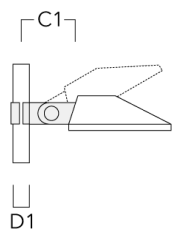

Pole clamp SI1-240/260, single (Ø 114-133)	108-0483	210	114-133	4.40	210
--	----------	-----	---------	------	-----

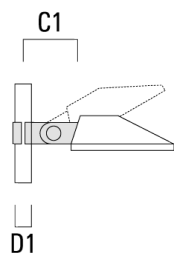

PFL240 LED

Pole mounted

Description	Part ID	C1	D1	Weight (kg)	C
Pole clamp SI2-240/260, double (Ø 76-89)	108-0484	210	76-89	5.20	210

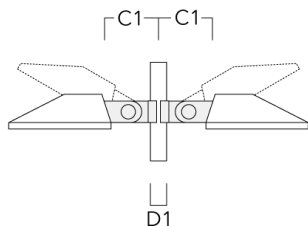

Pole clamp SI2-240/260, double (Ø 114-133)	108-0485	210	114-133	6.20	210
--	----------	-----	---------	------	-----

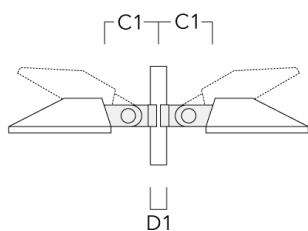

PFL240 LED

Pole mounted

Pole clamp SK

Description	Part ID	C1	D1	Weight (kg)	C
Pole clamp SK1-240, single (Ø 76-89)	108-0788	175	76-89	3	175

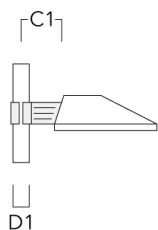

Pole clamp SK1-240, single (Ø 114-133)	108-0789	175	114-133	3.80	175
--	----------	-----	---------	------	-----

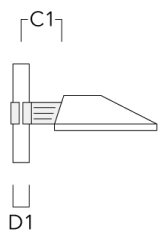

PFL240 LED

Pole mounted

Description	Part ID	C1	D1	Weight (kg)	C
Pole clamp SK2-240, double (Ø 76-89)	108-0790	175	76-89	3.90	175

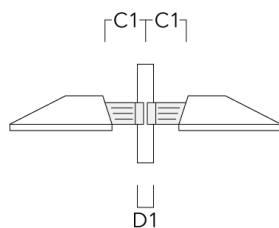

Pole clamp SK2-240, double (Ø 114-133)	108-0791	175	114-133	4.70	175
--	----------	-----	---------	------	-----

