

CFT530 LED

Pole mounted

we-ef

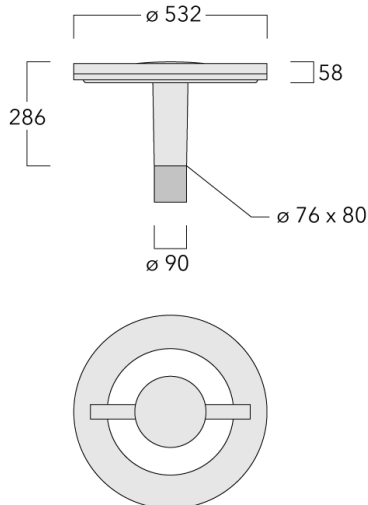

Description

IP66. Class I. IK08. Marine-grade, die-cast aluminium alloy. 5CE superior corrosion protection including PCS hardware. RFC™ Reflection Free Contour main lens. Silicone CCG® Controlled Compression Gasket. The luminaire is factory-sealed and does not need to be opened during installation.

Integral EC electronic converter. DALI interface. Advanced thermal management protects LEDs while optimising lumens output. Removable LED boards for upgrading. CAD-optimised optics for superior illumination and glare control. OLC® One LED Concept. Optional 2200 K version available. To be specified at time of ordering.

Recommended mounting height 3.0-4.5 m, depending on wattage selected.

WE-EF LIGHTING (Thailand) Co., Ltd.

57 Moo 5, Kingkaew Rd., Bangplee, 10540 Samutprakarn - Phone: +66 2 738 96 20 - Fax: +66 2 738 96 29

<https://we-ef.com/asia>

Subject to technical changes and errors. - Generated on 23/11/2024





CFT530 LED

Pole mounted

we-ef

Specifications

Material description

Body	Marine-grade, die-cast aluminium alloy
Lens	RFC™ Reflection Free Contour main lens
Colours	 RAL9004 Signal black  RAL9007 Grey aluminium  RAL7016 Anthracite grey  RAL9016 Traffic white
Gasket	Silicone CCG® Controlled Compression Gasket
Fasteners	PCS hardware
Ingress protection	IP66
Impact resistance	IK08
Corrosion resistance	5CE
Windage	0.16 m ²

Electrical description

Power supply	220-240V / 50-60 Hz
Driver / Ballast	Integral electronic converter with DALI interface
Power factor	> 0.9

Additional information

Lifetime	Ta=25° L90B10 > 90000h
BUG Rating	Please see individual Spec Sheets for classification of Backlight, Uplight and Glare

WE-EF LIGHTING (Thailand) Co., Ltd.

57 Moo 5, Kingkaew Rd., Bangplee, 10540 Samutprakarn - Phone: +66 2 738 96 20 - Fax: +66 2 738 96 29

<https://we-ef.com/asia>

Subject to technical changes and errors. - Generated on 23/11/2024

CFT530 LED

Pole mounted

we-ef

Options

Light distribution



controlled symmetric distribution [C50]



rectangular [R]

Colour temperature



3000 K



4000 K



2700 K

Nominal Watt

0 W

CFT530 LED

Pole mounted

we-ef

Configurations

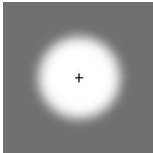
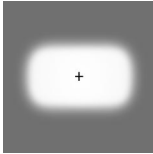
Light distribution	Part ID	Light source	Rated lumens	Rated input power	CRI	Weight (kg)
controlled symmetric distribution [C50] 	105-0092	LED-24/24W / 350 mA - 3000 K	3510.8	26.5 W	80	9.80
	105-0093	LED-24/24W / 350 mA - 4000 K	3850.6	26.5 W	80	9.80
	105-0096	LED-24/48W / 700 mA - 3000 K	6251.1	54 W	80	9.80
	105-0097	LED-24/48W / 700 mA - 4000 K	6682.2	54 W	80	9.80
	105-0237	LED-24/24W / 350 mA - 2700 K	3284.3	26.5 W	80	9.80
	105-0238	LED-24/48W / 700 mA - 2700 K	5820	54 W	80	9.80
rectangular [R] 	105-0094	LED-24/24W / 350 mA - 3000 K	3472.4	26.5 W	80	9.80
	105-0095	LED-24/24W / 350 mA - 4000 K	3808.5	26.5 W	80	9.80
	105-0098	LED-24/48W / 700 mA - 3000 K	6182.6	54 W	80	9.80
	105-0099	LED-24/48W / 700 mA - 4000 K	6609	54 W	80	9.80
	105-0239	LED-24/24W / 350 mA - 2700 K	3248.4	26.5 W	80	9.80
	105-0240	LED-24/48W / 700 mA - 2700 K	5756.2	54 W	80	9.80

WE-EF LIGHTING (Thailand) Co., Ltd.

57 Moo 5, Kingkaew Rd., Bangplee, 10540 Samutprakarn - Phone: +66 2 738 96 20 - Fax: +66 2 738 96 29

<https://we-ef.com/asia>

Subject to technical changes and errors. - Generated on 23/11/2024