

### Description





IP66, Class I. Class II on request.

IK07. Marine-grade, die-cast aluminium alloy. 5CE superior corrosion protection including PCS hardware. Silicone CCG® Controlled Compression Gasket. Safety glass lens. One cable gland. Second gland for through wiring on request. Integral EC electronic converter, thermally separated. CAD-optimised optics for superior illumination and glare control. OLC® One LED Concept. Factory installed LED circuit board. 1-10V, DALI Interface or Eco Step Dim® on request. Maximum one internal optical accessory possible.

Optional 2200 K version up to max. 1050mA available, except version [EES]. To be specified at time of ordering.

**Specifications****Material description**

---

Body	Marine-grade, die-cast aluminium alloy
Lens	Safety glass lens
Colours	 RAL9004 Signal black  RAL9006 White aluminium  RAL9007 Grey aluminium  RAL7016 Anthracite grey  RAL9016 Traffic white
Gasket	Silicone CCG® Controlled Compression Gasket
Fasteners	PCS Polymer Coated Stainless Steel Hardware
Ingress protection	IP66
Impact resistance	IK07
Corrosion resistance	5CE
Windage	0.054 m <sup>2</sup>

---

**Electrical description**

---

Power supply	220-240V / 50-60 Hz
Driver / Ballast	Standard. Optional DALI version available. To be specified at time of ordering.
Power factor	> 0.9
Surge protection	6/6 kV (optional SP10)

---

**Additional information**

---

Lifetime	Ta=25° L90B10 > 90000h
Energy efficiency class	C-D (Light source)

---

### Options

#### Light distribution



symmetric, medium beam [M]



symmetric, narrow beam [E]



symmetric, very narrow beam [EE]



symmetric, wide beam [B]



linear spread, very narrow beam [EE]



wallwash



symmetric, very narrow beam, sharp cut-off [EES]

#### Colour temperature



3000 K



4000 K



2700 K

#### Nominal Watt



0 W



36 W

48 W

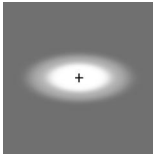
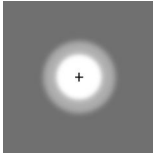
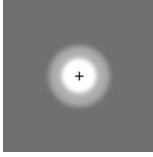
72 W

### Configurations

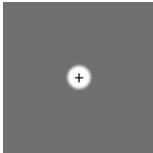
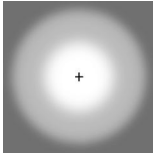
Light distribution	Part ID	Light source	Rated lumens	Rated input power	CRI	Weight (kg)
linear spread, very narrow beam [EE] 	139-1834+139-1849	LED-12/24W / 700 mA - 3000 K	2973.9	27 W	80	7.60
	139-1835+139-1849	LED-12/24W / 700 mA - 4000 K	3179	27 W	80	7.60
	139-1840+139-1849	LED-12/36W / 1050 mA - 3000 K	4409.6	41 W	80	7.60
	139-1841+139-1849	LED-12/36W / 1050 mA - 4000 K	4614.7	41 W	80	7.60
	139-1846+139-1849	LED-12/52W / 1400 mA - 3000 K	5425.3	55 W	80	7.60
	139-1847+139-1849	LED-12/52W / 1400 mA - 4000 K	5671.9	55 W	80	7.60
	139-2077+139-1849	LED-12/36W / 1050 mA - 2700 K	4204.5	41 W	80	7.60
	139-2191+139-1849	LED-12/52W / 1400 mA - 2700 K	5129.4	55 W	80	7.60
	139-2263+139-1849	LED-12/24W / 700 mA - 2700 K	4971.9	54 W	80	7.60
symmetric, medium beam [M] 	139-1830	LED-12/24W / 700 mA - 3000 K	3152.3	27 W	80	7.60
	139-1831	LED-12/24W / 700 mA - 4000 K	3369.7	27 W	80	7.60
	139-1836	LED-12/36W / 1050 mA - 3000 K	4674.1	41 W	80	7.60
	139-1837	LED-12/36W / 1050 mA - 4000 K	4891.5	41 W	80	7.60
	139-1842	LED-12/52W / 1400 mA - 3000 K	5748.8	55 W	80	7.60
	139-1843	LED-12/52W / 1400 mA - 4000 K	6010.1	55 W	80	7.60
	139-2108	LED-12/52W / 1400 mA - 2700 K	5435.2	55 W	80	7.60
	139-2151	LED-12/24W / 700 mA - 2700 K	2934.9	27 W	80	7.60
	139-2240	LED-12/36W / 1050 mA - 2700 K	4456.7	41 W	80	7.60
symmetric, narrow beam [E] 	139-1832	LED-12/24W / 700 mA - 3000 K	2965.5	27 W	80	7.60
	139-1833	LED-12/24W / 700 mA - 4000 K	3170	27 W	80	7.60
	139-1838	LED-12/36W / 1050 mA - 3000 K	4397.1	41 W	80	7.60
	139-1839	LED-12/36W / 1050 mA - 4000 K	4601.7	41 W	80	7.60
	139-1844	LED-12/52W / 1400 mA - 3000 K	5412.2	55 W	80	7.60
	139-1845	LED-12/52W / 1400 mA - 4000 K	5658.2	55 W	80	7.60
	139-2079	LED-12/36W / 1050 mA - 2700 K	4192.6	41 W	80	7.60
	139-2079+139-1849	LED-12/36W / 1050 mA - 2700 K	4192.6	41 W	80	7.60
	139-2214	LED-12/52W / 1400 mA - 2700 K	5117	55 W	80	7.60
symmetric, very narrow beam [EE] 	139-1834	LED-12/24W / 700 mA - 3000 K	3120.5	27 W	80	7.60
	139-1835	LED-12/24W / 700 mA - 4000 K	3335.7	27 W	80	7.60
	139-1840	LED-12/36W / 1050 mA - 3000 K	4627	41 W	80	7.60
	139-1841	LED-12/36W / 1050 mA - 4000 K	4842.2	41 W	80	7.60
	139-1846	LED-12/52W / 1400 mA - 3000 K	5800	55 W	80	7.60
	139-1847	LED-12/52W / 1400 mA - 4000 K	6063.7	55 W	80	7.60
	139-2077	LED-12/36W / 1050 mA - 2700 K	4411.8	41 W	80	7.60

Light distribution	Part ID	Light source	Rated lumens	Rated input power	CRI	Weight (kg)	
symmetric, very narrow beam, sharp cut-off [EES] 	139-2191	LED-12/52W / 1400 mA - 2700 K	5483.7	55 W	80	7.60	
	139-2263	LED-12/24W / 700 mA - 2700 K	2905.3	27 W	80	7.60	
	139-3125	LED-24/36W / 500 mA - 2700K	3249.5	39 W	80	7.60	
	139-3126	LED-24/36W / 500 mA - 3000 K	3473.6	39 W	80	7.60	
	139-3127	LED-24/36W / 500 mA - 4000 K	3473.6	39 W	80	7.60	
	139-3129	LED-24/48W / 700 mA - 2700 K	4257.9	54 W	80	7.60	
	139-3130	LED-24/48W / 700 mA - 3000 K	4594.1	54 W	80	7.60	
	139-3131	LED-24/48W / 700 mA - 4000 K	4594.1	54 W	80	7.60	
	139-3133	LED-24/72W / 1050 mA - 2700 K	4257.9	81 W	80	7.60	
	139-3134	LED-24/72W / 1050 mA - 3000 K	4594.1	81 W	80	7.60	
	139-3135	LED-24/72W / 1050 mA - 4000 K	4594.1	81 W	80	7.60	
	symmetric, wide beam [B] 	139-1907	LED-12/24W / 700 mA - 3000 K	2990.7	27 W	80	7.60
		139-1908	LED-12/24W / 700 mA - 4000 K	3197	27 W	80	7.60
139-1909		LED-12/36W / 1050 mA - 3000 K	4434.5	41 W	80	7.60	
139-1910		LED-12/36W / 1050 mA - 4000 K	4640.7	41 W	80	7.60	
139-1911		LED-12/52W / 1400 mA - 3000 K	5480.4	55 W	80	7.60	
139-1912		LED-12/52W / 1400 mA - 4000 K	5729.5	55 W	80	7.60	
139-2226		LED-12/52W / 1400 mA - 2700 K	5181.4	55 W	80	7.60	
139-2239		LED-12/36W / 1050 mA - 2700 K	4228.2	41 W	80	7.60	
139-2241		LED-12/24W / 700 mA - 2700 K	2784.4	27 W	80	7.60	
wallwash 		139-1830+139-1848	LED-12/24W / 700 mA - 3000 K	2617.9	27 W	80	7.60
		139-1831+139-1848	LED-12/24W / 700 mA - 4000 K	2798.5	27 W	80	7.60
	139-1836+139-1848	LED-12/36W / 1050 mA - 3000 K	3881.7	41 W	80	7.60	
	139-1837+139-1848	LED-12/36W / 1050 mA - 4000 K	4062.3	41 W	80	7.60	
	139-1842+139-1848	LED-12/52W / 1400 mA - 3000 K	4774.1	55 W	80	7.60	
	139-1843+139-1848	LED-12/52W / 1400 mA - 4000 K	4991.1	55 W	80	7.60	
	139-2108+139-1848	LED-12/52W / 1400 mA - 2700 K	4513.7	55 W	80	7.60	
	139-2151+139-1848	LED-12/24W / 700 mA - 2700 K	2437.4	27 W	80	7.60	
	139-2240+139-1848	LED-12/36W / 1050 mA - 2700 K	3701.2	41 W	80	7.60	

**Mounting Accessories**

**Short post EM**

Description	Part ID	D1	D2	H1	M1	Weight (kg)
EM1-M16 AL	270-9038	160	130	203	9	2

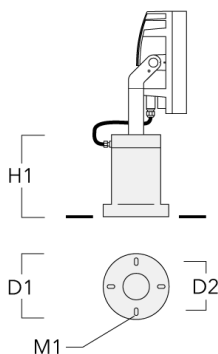

**Floodlight mounting bracket TA**

Description	Part ID	A	C1	D x L1	Weight (kg)	D x S
TA1 Mounting bracket, single (Ø 108 x 200)	147-0096		130	108 x 200	7.50	108 x 200

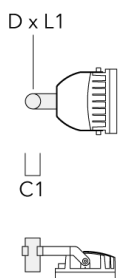

Description	Part ID	A	C1	D × L1	Weight (kg)	D × S
TA2 Mounting bracket, double (Ø 108 x 200)	147-0097		130	108 x 200	7.50	108 x 200

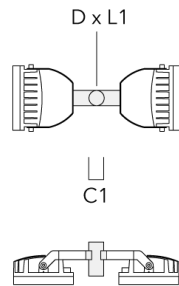

TA2-L Mounting bracket, double (Ø 108 x 200)	147-0148	±90°	420	108 x 200	20.20	108 x 200
--	----------	------	-----	-----------	-------	-----------

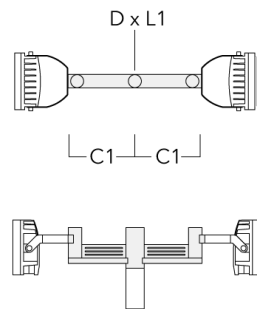

**Projectors**

Description	Part ID	A	C1	D x L1	Weight (kg)	D x S
TA2-L Mounting bracket, double (Ø 76 x 200)	147-0105	±90°	420	76 x 200	16.10	76 x 200

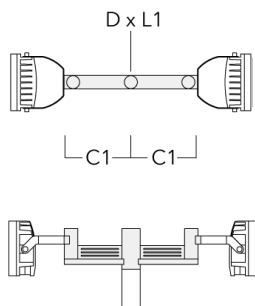

TA3 Mounting bracket, triple (Ø 89 x 200)	147-0025	±90°	650	89 x 200	17.90	89 x 200
---	----------	------	-----	----------	-------	----------

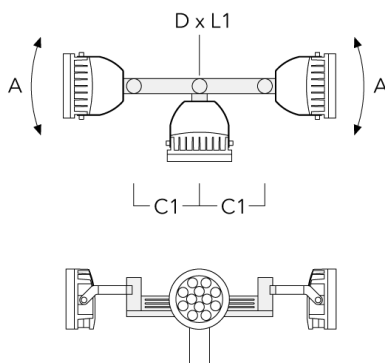



## Projectors

Description	Part ID	A	C1	D x L1	Weight (kg)	D x S
TA3 Mounting bracket, triple (Ø 108 x 200)	147-0098	±90°	650	108 x 200	24.20	108 x 200

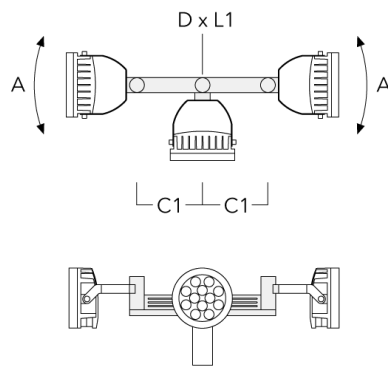

TA4 Mounting bracket, quad (Ø 89 x 200)	147-0099	±90°	650	89 x 200	20.80	89 x 200
---	----------	------	-----	----------	-------	----------

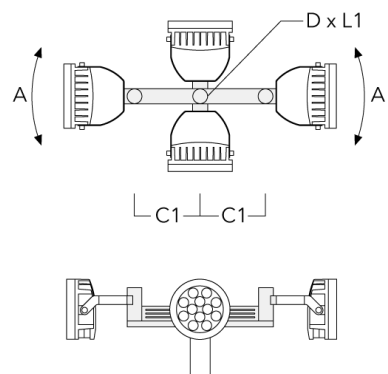

Description	Part ID	A	C1	D x L1	Weight (kg)	D x S
TA4 Mounting bracket, quad (Ø 108 x 200)	147-0100	±90°	650	108 x 200	24.20	108 x 200

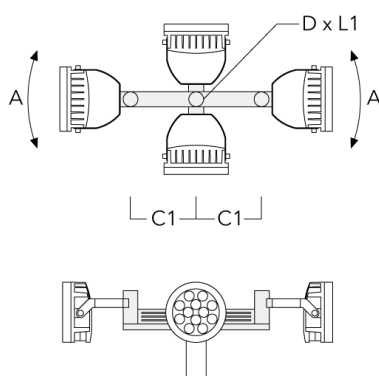

TA2 Mounting bracket, double* (Ø 76 x 200)	147-0024		130	76 x 200	1.90	76 x 200
--	----------	--	-----	----------	------	----------

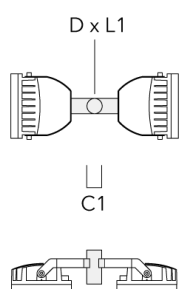

## Projectors

Description	Part ID	A	C1	D × L1	Weight (kg)	D × S
TA1 Mounting bracket, single* (Ø 76 x 200)	147-0023		130	76 x 200	1.50	76 x 200

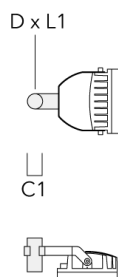

## Pole clamp TS

Description	Part ID	D1	Weight (kg)	D
TS1-2/M12 Pole clamp, single (Ø 102-114)	147-0526	102-114	1.50	102-114

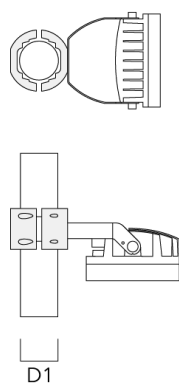

## Projectors

Description	Part ID	D1	Weight (kg)	D
TS1-2/M12 Pole clamp, single (Ø 114-133)	147-0544	114-133	1.70	114-133

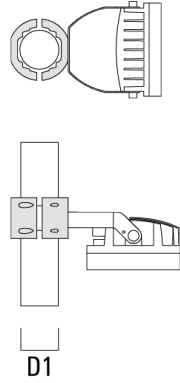

TS1-2/M12 Pole clamp, single (Ø 76-89)	147-0543	76-89	1.40	76-89
--	----------	-------	------	-------

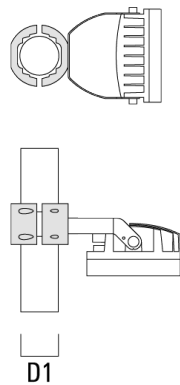

## Projectors

Description	Part ID	D1	Weight (kg)	D
TS2-2/M12 Pole clamp, double (Ø 76-89)	147-0545	76-89	1.40	76-89

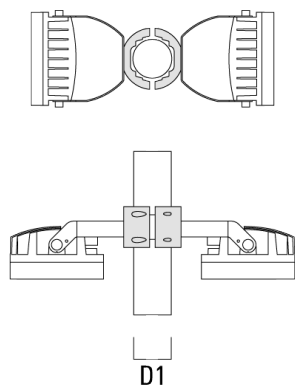

TS2-2/M12 Pole clamp, double (Ø 114-133)	147-0546	114-133	1.60	114-133
--	----------	---------	------	---------

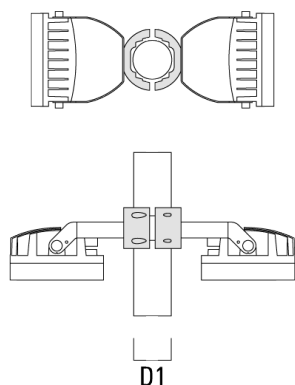

**Projectors**

Description	Part ID	D1	Weight (kg)	D
TS2-2/M12 Pole clamp, double (Ø 102-114)	147-0527	102-114	1.50	102-114

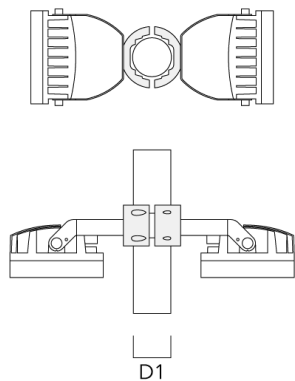

**Planted root**

Description	Part ID	D1	D2	D3	D4	H1	H2	M1	Weight (kg)
Planted root ESV4	300-0461	145	130	102	108	400	350	8	7.05

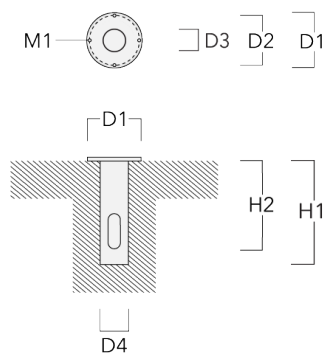

**Pole clamp PC**

Description	Part ID	D1	Weight (kg)
PC2 76-89/60 Pole clamp, double (Ø 76-89)	139-2703	76-89	1.00

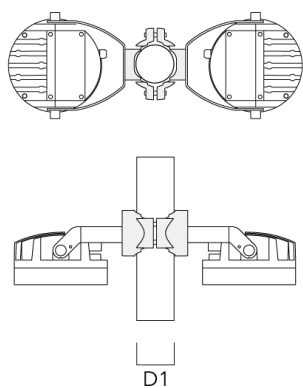

PC1 76-89/60 Pole clamp, single (Ø 76-89)	139-2702	76-89	1.00
---	----------	-------	------

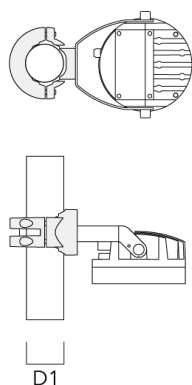

Description	Part ID	D1	Weight (kg)
PC2 102-114/60 Pole clamp, double (Ø 102-114)	139-2707	102-114	1.20



PC1 102-114/60 Pole clamp, single (Ø 102-114)	139-2706	102-114	1.20
--	----------	---------	------





Description	Part ID	D1	Weight (kg)
PC2 114-133/60 Pole clamp, double (Ø 114-133)	139-2709	114-133	1.40

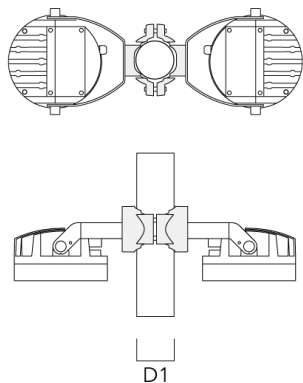

PC1 114-133/60 Pole clamp, single (Ø 114-133)	139-2708	114-133	1.40
--	----------	---------	------

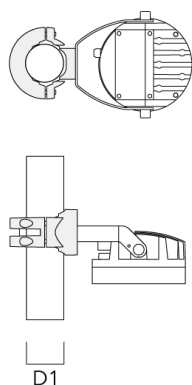

Description	Part ID	D1	Weight (kg)
PC2 82-109/60 Pole camp, double (Ø 82-109)	139-2705	82-109	1.10

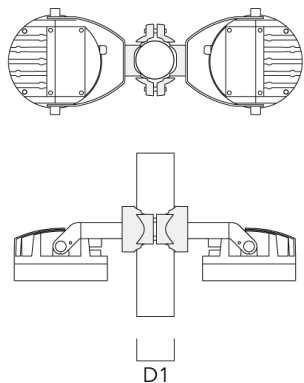

PC1 82-109/60 Pole camp, single (Ø 82-109)	139-2704	82-109	1.10
--	----------	--------	------

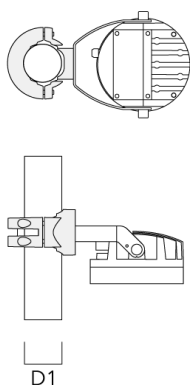

**Control****Eco Step Dim® Basic**

Description	Part ID
Eco Step Dim® Basic LED	430-0001

**Eco Step Dim® Advanced**

Description	Part ID
Eco Step Dim® Advanced LED	430-0002

**R2C Ready to Connect**

Description	Part ID
R2C Ready to Connect (top)	430-0019

**Optical Accessories****Linear spread lens**

---

Description	Part ID	C1
IO-180-FLC230-LED	139-1849	199

---

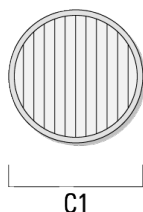

---

**Flood lens**

---

Description	Part ID	C1
IO-360-FLC230-LED	139-1850	199

---

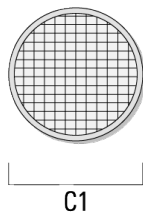

**Honeycomb louvre**

Description	Part ID	C1
IW-FLC230-LED - [E][EE][EES]	139-1851	199

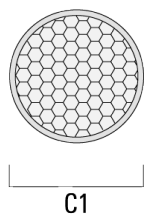

**Glare shield**

Description	Part ID	A	C1
ES-FLC230-LED	139-1852	159	266

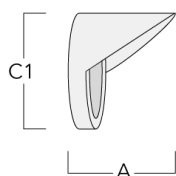

### Snoot

Description	Part ID	A	C1
ET-FLC230-LED	139-1853	160	266

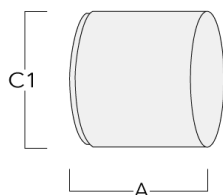

### Wallwash lens

Description	Part ID	C1
IO-20-FLC230-LED	139-1848	199

