



**Beschreibung**

IP66, SKI. SKII auf Anfrage. IK07. Korrosionsbeständiger Aluminiumguss. PCS beschichtete Edelstahlschrauben. 5CE Korrosionsschutz. CCG® Controlled Compression Gasket Silikondichtung. Sicherheitsglas. Eine Kabelverschraubung, eine zweite Kabelverschraubung zur Durchverdrahtung auf Anfrage. Eingebaute elektronische Betriebsgeräte, thermisch getrennt. CAD-optimierte OLC® One LED Concept Technik zur Lichtlenkung und Entblendung. Eingebaute LED Platine. 1-10V, DALI Schnittstelle oder Eco Step Dim® auf Anfrage. Maximal ein internes Zubehörteil möglich. Variante mit 2200 K bis max. 1050 mA erhältlich, nicht für [EES] Version. Bei Bestellung bitte angeben.

Spezifikationen**Materialbeschreibung**

Gehäuse	Korrosionsbeständiger Aluminiumguss
Abdeckung	Sicherheitsglasscheibe
Farben	 RAL9004 Signalschwarz  RAL9006 Weißaluminium  RAL9007 Graualuminium  RAL7016 Anthrazitgrau  RAL9016 Verkehrsweiß
Dichtung	CCG® Silikondichtung
Schrauben	PCS beschichtete Edelstahlschrauben
Schutzart	IP66
Schlagfestigkeit	IK07
Korrosionsbeständigkeit	5CE
Windangriffsfläche	0.054 m ²

Elektrische Beschreibung

Netz	220-240V / 50-60 Hz
Netzgerät / Vorschaltgerät	Standard. Variante mit DALI erhältlich, bei Bestellung bitte angeben.
Leistungsfaktor	> 0,9
Überspannungsschutz	6/6 kV (SP10 optional)

Weitere Informationen

Lebensdauer	Ta=25° L90B10 > 90000h
Energieeffizienzklasse	C-D (Lichtquelle)

Auswahl

Lichtverteilung



symmetrisch mediumstrahlend [M]



symmetrisch engstrahlend [E]



symmetrisch extrem engstrahlend [EE]



symmetrisch breitstrahlend [B]



bandförmig extrem engstrahlend [EE]



wallwash



symmetrisch extrem engstrahlend, 'sharp cut-off' [EES]

Farbtemperaturen



3000 K



4000 K



2700 K

Nominal Watt



0 W

36 W

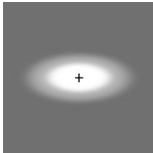
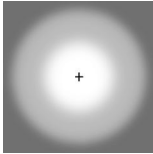

48 W

72 W

Konfigurationen

Lichtverteilung	Artikelnummer	Lichtquelle	Bemes- sungslicht- strom	Bemes- sungslei- stung	CRI	Gewicht (kg)
bandförmig extrem engstrahlend [EE] 	139-1834+139-1849	LED-12/24W / 700 mA - 3000 K	2973.9	27 W	80	7.60
	139-1835+139-1849	LED-12/24W / 700 mA - 4000 K	3179	27 W	80	7.60
	139-1840+139-1849	LED-12/36W / 1050 mA - 3000 K	4409.6	41 W	80	7.60
	139-1841+139-1849	LED-12/36W / 1050 mA - 4000 K	4614.7	41 W	80	7.60
	139-1846+139-1849	LED-12/52W / 1400 mA - 3000 K	5425.3	55 W	80	7.60
	139-1847+139-1849	LED-12/52W / 1400 mA - 4000 K	5671.9	55 W	80	7.60
	139-2077+139-1849	LED-12/36W / 1050 mA - 2700 K	4204.5	41 W	80	7.60
	139-2191+139-1849	LED-12/52W / 1400 mA - 2700 K	5129.4	55 W	80	7.60
	139-2263+139-1849	LED-12/24W / 700 mA - 2700 K	4971.9	54 W	80	7.60
symmetrisch breitstrahlend [B] 	139-1907	LED-12/24W / 700 mA - 3000 K	2990.7	27 W	80	7.60
	139-1908	LED-12/24W / 700 mA - 4000 K	3197	27 W	80	7.60
	139-1909	LED-12/36W / 1050 mA - 3000 K	4434.5	41 W	80	7.60
	139-1910	LED-12/36W / 1050 mA - 4000 K	4640.7	41 W	80	7.60
	139-1911	LED-12/52W / 1400 mA - 3000 K	5480.4	55 W	80	7.60
	139-1912	LED-12/52W / 1400 mA - 4000 K	5729.5	55 W	80	7.60
	139-2226	LED-12/52W / 1400 mA - 2700 K	5181.4	55 W	80	7.60
	139-2239	LED-12/36W / 1050 mA - 2700 K	4228.2	41 W	80	7.60
	139-2241	LED-12/24W / 700 mA - 2700 K	2784.4	27 W	80	7.60
symmetrisch engstrahlend [E] 	139-1832	LED-12/24W / 700 mA - 3000 K	2965.5	27 W	80	7.60
	139-1833	LED-12/24W / 700 mA - 4000 K	3170	27 W	80	7.60
	139-1838	LED-12/36W / 1050 mA - 3000 K	4397.1	41 W	80	7.60
	139-1839	LED-12/36W / 1050 mA - 4000 K	4601.7	41 W	80	7.60
	139-1844	LED-12/52W / 1400 mA - 3000 K	5412.2	55 W	80	7.60
	139-1845	LED-12/52W / 1400 mA - 4000 K	5658.2	55 W	80	7.60
	139-2079	LED-12/36W / 1050 mA - 2700 K	4192.6	41 W	80	7.60
	139-2079+139-1849	LED-12/36W / 1050 mA - 2700 K	4192.6	41 W	80	7.60
	139-2214	LED-12/52W / 1400 mA - 2700 K	5117	55 W	80	7.60
	139-2242	LED-12/24W / 700 mA - 2700 K	2761	27 W	80	7.60
	symmetrisch extrem engstrahlend [EE] 	139-1834	LED-12/24W / 700 mA - 3000 K	3120.5	27 W	80
139-1835		LED-12/24W / 700 mA - 4000 K	3335.7	27 W	80	7.60
139-1840		LED-12/36W / 1050 mA - 3000 K	4627	41 W	80	7.60
139-1841		LED-12/36W / 1050 mA - 4000 K	4842.2	41 W	80	7.60
139-1846		LED-12/52W / 1400 mA - 3000 K	5800	55 W	80	7.60
139-1847		LED-12/52W / 1400 mA - 4000 K	6063.7	55 W	80	7.60

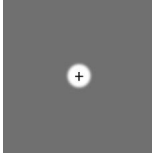
Scheinwerfer symmetrisch

Lichtverteilung	Artikelnummer	Lichtquelle	Bemes- sungslicht- strom	Bemes- sungsleis- tung	CRI	Gewicht (kg)
symmetrisch extrem engstrahlend, 'sharp cut-off' [EES] 	139-2077	LED-12/36W / 1050 mA - 2700 K	4411.8	41 W	80	7.60
	139-2191	LED-12/52W / 1400 mA - 2700 K	5483.7	55 W	80	7.60
	139-2263	LED-12/24W / 700 mA - 2700 K	2905.3	27 W	80	7.60
	139-3125	LED-24/36W / 500 mA - 2700K	3249.5	39 W	80	7.60
	139-3126	LED-24/36W / 500 mA - 3000 K	3473.6	39 W	80	7.60
	139-3127	LED-24/36W / 500 mA - 4000 K	3473.6	39 W	80	7.60
	139-3129	LED-24/48W / 700 mA - 2700 K	4257.9	54 W	80	7.60
	139-3130	LED-24/48W / 700 mA - 3000 K	4594.1	54 W	80	7.60
	139-3131	LED-24/48W / 700 mA - 4000 K	4594.1	54 W	80	7.60
	139-3133	LED-24/72W / 1050 mA - 2700 K	4257.9	81 W	80	7.60
139-3134	LED-24/72W / 1050 mA - 3000 K	4594.1	81 W	80	7.60	
139-3135	LED-24/72W / 1050 mA - 4000 K	4594.1	81 W	80	7.60	
symmetrisch mediumstrahlend [M] 	139-1830	LED-12/24W / 700 mA - 3000 K	3152.3	27 W	80	7.60
	139-1831	LED-12/24W / 700 mA - 4000 K	3369.7	27 W	80	7.60
	139-1836	LED-12/36W / 1050 mA - 3000 K	4674.1	41 W	80	7.60
	139-1837	LED-12/36W / 1050 mA - 4000 K	4891.5	41 W	80	7.60
	139-1842	LED-12/52W / 1400 mA - 3000 K	5748.8	55 W	80	7.60
	139-1843	LED-12/52W / 1400 mA - 4000 K	6010.1	55 W	80	7.60
	139-2108	LED-12/52W / 1400 mA - 2700 K	5435.2	55 W	80	7.60
	139-2151	LED-12/24W / 700 mA - 2700 K	2934.9	27 W	80	7.60
	139-2240	LED-12/36W / 1050 mA - 2700 K	4456.7	41 W	80	7.60
	wallwash 	139-1830+139-1848	LED-12/24W / 700 mA - 3000 K	2617.9	27 W	80
139-1831+139-1848		LED-12/24W / 700 mA - 4000 K	2798.5	27 W	80	7.60
139-1836+139-1848		LED-12/36W / 1050 mA - 3000 K	3881.7	41 W	80	7.60
139-1837+139-1848		LED-12/36W / 1050 mA - 4000 K	4062.3	41 W	80	7.60
139-1842+139-1848		LED-12/52W / 1400 mA - 3000 K	4774.1	55 W	80	7.60
139-1843+139-1848		LED-12/52W / 1400 mA - 4000 K	4991.1	55 W	80	7.60
139-2108+139-1848		LED-12/52W / 1400 mA - 2700 K	4513.7	55 W	80	7.60
139-2151+139-1848		LED-12/24W / 700 mA - 2700 K	2437.4	27 W	80	7.60
139-2240+139-1848	LED-12/36W / 1050 mA - 2700 K	3701.2	41 W	80	7.60	

Montagezubehör

Montagesockel EM

Beschreibung	Artikelnummer	D1	D2	H1	M1	Gewicht (kg)
EM1-M16 AL	270-9038	160	130	203	9	2

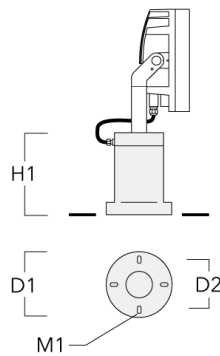

Mastaufsatztraverse TA

Beschreibung	Artikelnummer	A	C1	D x L1	Gewicht (kg)	D x S
TA1 Mastaufsatztraverse, einfach (Ø 108 x 200)	147-0096		130	108 x 200	7.50	108 x 200

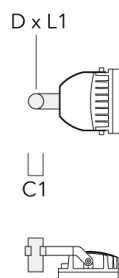

Scheinwerfer symmetrisch

Beschreibung	Artikelnummer	A	C1	D × L1	Gewicht (kg)	D × S
TA2 Mastaufsatztraverse, zweifach (Ø 108 x 200)	147-0097		130	108 x 200	7.50	108 x 200

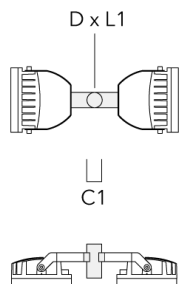

TA2-L Mastaufsatztraverse, zweifach (Ø 108 x 200)	147-0148	±90°	420	108 x 200	20.20	108 x 200
---	----------	------	-----	-----------	-------	-----------

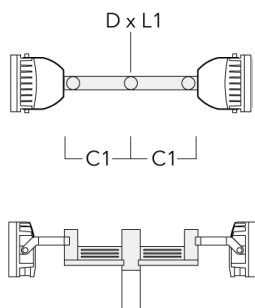

Scheinwerfer symmetrisch

Beschreibung	Artikelnummer	A	C1	D x L1	Gewicht (kg)	D x S
TA2-L Mastaufsatztraverse, zweifach (Ø 76 x 200)	147-0105	±90°	420	76 x 200	16.10	76 x 200

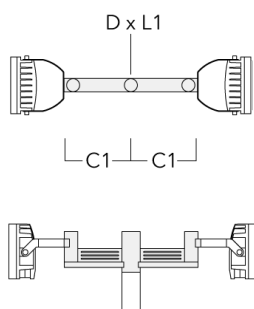

TA3 Mastaufsatztraverse, dreifach (Ø 89 x 200)	147-0025	±90°	650	89 x 200	17.90	89 x 200
--	----------	------	-----	----------	-------	----------

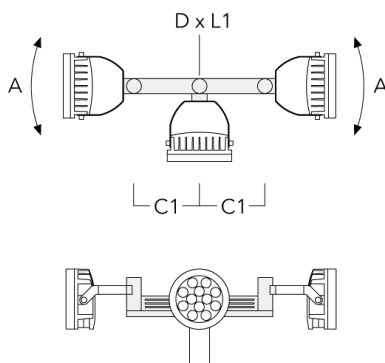

Scheinwerfer symmetrisch

Beschreibung	Artikelnummer	A	C1	D x L1	Gewicht (kg)	D x S
TA3 Mastaufsatztraverse, dreifach (Ø 108 x 200)	147-0098	±90°	650	108 x 200	24.20	108 x 200

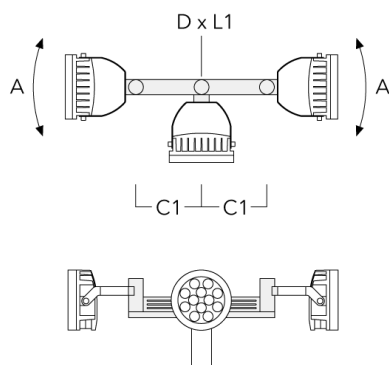

TA4 Mastaufsatztraverse, vierfach (Ø 89 x 200)	147-0099	±90°	650	89 x 200	20.80	89 x 200
--	----------	------	-----	----------	-------	----------

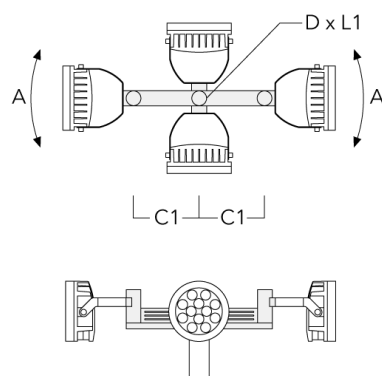

Scheinwerfer symmetrisch

Beschreibung	Artikelnummer	A	C1	D × L1	Gewicht (kg)	D × S
TA4 Mastaufsatztraverse, vierfach (Ø 108 x 200)	147-0100	±90°	650	108 x 200	24.20	108 x 200

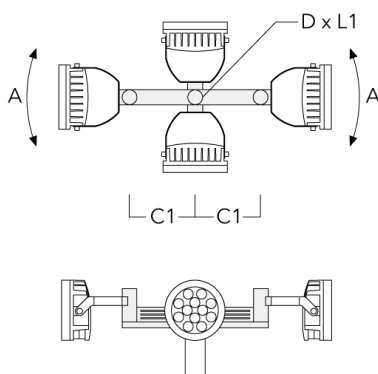

TA2 Mastaufsatztraverse, zweifach (Ø 76 x 200)	147-0024		130	76 x 200	1.90	76 x 200
--	----------	--	-----	----------	------	----------

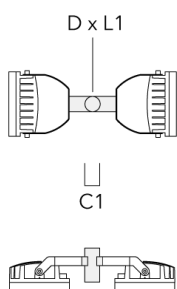

Scheinwerfer symmetrisch

Beschreibung	Artikelnummer	A	C1	D × L1	Gewicht (kg)	D × S
TA1 Mastaufsatztraverse, einfach* (Ø 76 x 200)	147-0023		130	76 x 200	1.50	76 x 200

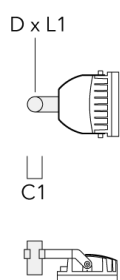

Mastschelle TS

Beschreibung	Artikelnummer	D1	Gewicht (kg)	D
TS1-2/M12 Mastschelle, einfach (Ø 102-114)	147-0526	102-114	1.50	102-114

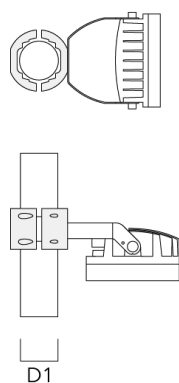

Scheinwerfer symmetrisch

Beschreibung	Artikelnummer	D1	Gewicht (kg)	D
TS1-2/M12 Mastschelle, einfach (Ø 114-133)	147-0544	114-133	1.70	114-133

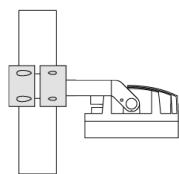
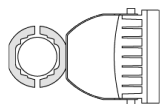

D1

TS1-2/M12 Mastschelle, einfach (Ø 76-89)	147-0543	76-89	1.40	76-89
--	----------	-------	------	-------

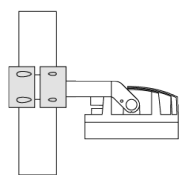
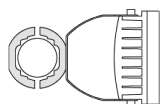

D1

Scheinwerfer symmetrisch

Beschreibung	Artikelnummer	D1	Gewicht (kg)	D
TS2-2/M12 Mastschelle, zweifach (Ø 76-89)	147-0545	76-89	1.40	76-89

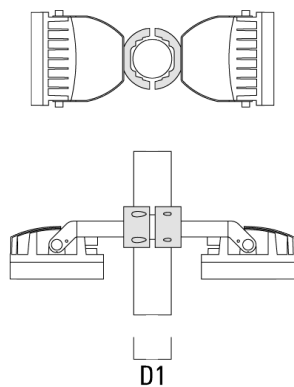

TS2-2/M12 Mastschelle, zweifach (Ø 114-133)	147-0546	114-133	1.60	114-133
---	----------	---------	------	---------

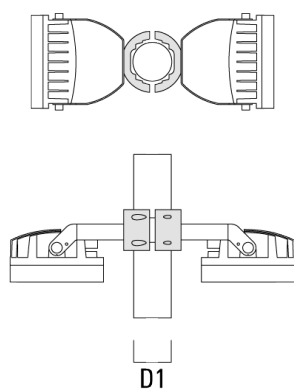

Scheinwerfer symmetrisch

Beschreibung	Artikelnummer	D1	Gewicht (kg)	D
TS2-2/M12 Mastschelle, zweifach (Ø 102-114)	147-0527	102-114	1.50	102-114

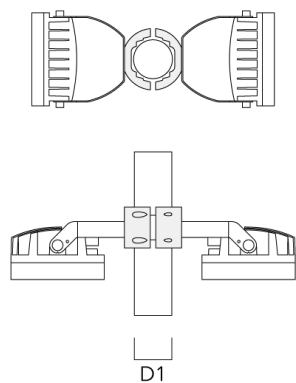

Erdstück

Beschreibung	Artikelnummer	D1	D2	D3	D4	H1	H2	M1	Gewicht (kg)
Erdstück ESV4	300-0461	145	130	102	108	400	350	8	7.05

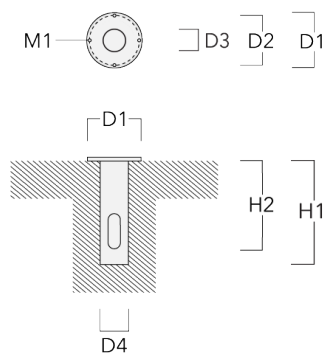

Scheinwerfer symmetrisch

Mastschelle PC

Beschreibung	Artikelnummer	D1	Gewicht (kg)
PC2 76-89/60 Mastschelle, zweifach (Ø 76-89)	139-2703	76-89	1.00

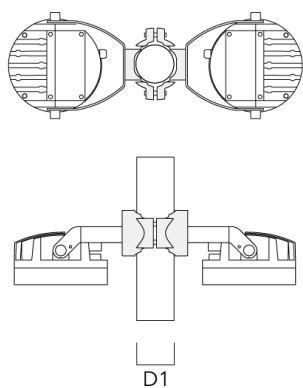

PC1 76-89/60 Mastschelle, einfach (Ø 76-89)	139-2702	76-89	1.00
---	----------	-------	------

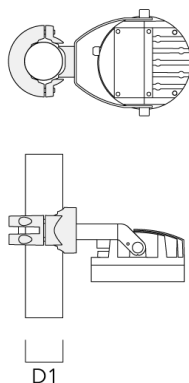

Scheinwerfer symmetrisch

Beschreibung	Artikelnummer	D1	Gewicht (kg)
PC2 102-114/60 Mastschelle, zweifach (Ø 102-114)	139-2707	102-114	1.20

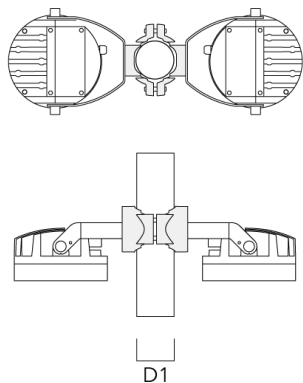

PC1 102-114/60 Mastschelle, einfach (Ø 102-114)	139-2706	102-114	1.20
--	----------	---------	------

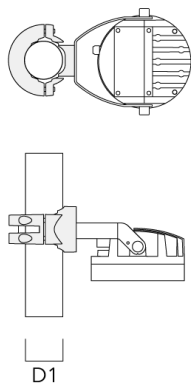

Scheinwerfer symmetrisch

Beschreibung	Artikelnummer	D1	Gewicht (kg)
PC2 114-133/60 Mastschelle, zweifach (Ø 114-133)	139-2709	114-133	1.40

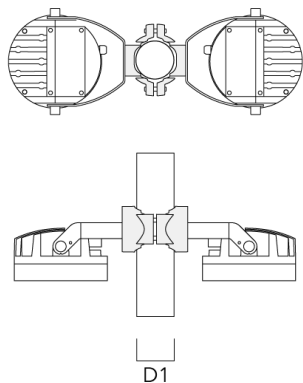

PC1 114-133/60 Mastschelle, einfach (Ø 114-133)	139-2708	114-133	1.40
---	----------	---------	------

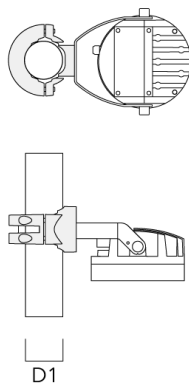

Scheinwerfer symmetrisch

Beschreibung	Artikelnummer	D1	Gewicht (kg)
PC2 82-109/60 Mastschelle, zweifach (Ø 82-109)	139-2705	82-109	1.10

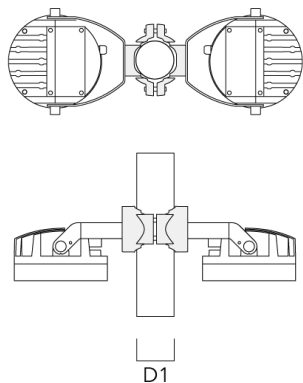

PC1 82-109/60 Mastschelle, einfach (Ø 82-109)	139-2704	82-109	1.10
--	----------	--------	------

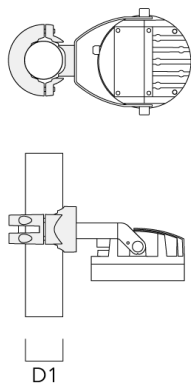

Steuerung**Eco Step Dim® Basic**

Beschreibung	Artikelnummer
Eco Step Dim® Basic LED	430-0001

Eco Step Dim® Advanced

Beschreibung	Artikelnummer
Eco Step Dim® Advanced LED	430-0002

R2C Ready to Connect

Beschreibung	Artikelnummer
R2C Ready to Connect (oben)	430-0019

Optisches Zubehör**Streulinse bandförmig**

Beschreibung	Artikelnummer	C1
IO-180-FLC230-LED	139-1849	199

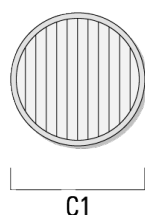

Streulinse allseitig

Beschreibung	Artikelnummer	C1
IO-360-FLC230-LED	139-1850	199

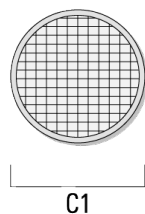

Wabenblende

Beschreibung	Artikelnummer	C1
IW-FLC230-LED - [E][EE][EES]	139-1851	199

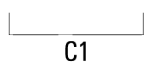
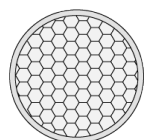

C1

Seitenblende

Beschreibung	Artikelnummer	A	C1
Seitenblende ES	139-1852	159	266

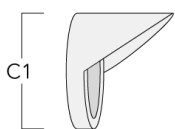

A

Scheinwerfer symmetrisch**Abblendtubus**

Beschreibung	Artikelnummer	A	C1
Abblendtubus ET	139-1853	160	266

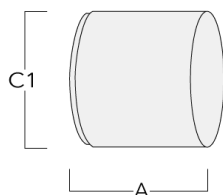
**Wallwash Linse**

Beschreibung	Artikelnummer	C1
IO-20-FLC230-LED	139-1848	199

