





### Description

IP66, Class I. Class II on request. IK07. Marine-grade, die-cast aluminium alloy. 5CE superior corrosion protection including PCS hardware. Silicone CCG® Controlled Compression Gasket. Safety glass lens. One cable gland. Second gland for through wiring on request. Integral EC electronic converter, thermally separated. CAD-optimised optics for superior illumination and glare control. OLC® One LED Concept. Factory installed LED circuit board. 1-10V, DALI Interface or Eco Step Dim® on request. Maximum one internal optical accessory possible.

Optional 2200 K version up to max. 1050mA available, except version [EES]. To be specified at time of ordering.

**Specifications****Material description**

---

|                      |   |
|----------------------|---|
| Body                 | Marine-grade, die-cast aluminium alloy  |
| Lens                 | Safety glass lens   |
| Colours              |  RAL9004 Signal black<br> RAL9006 White aluminium<br> RAL9007 Grey aluminium<br> RAL7016 Anthracite grey<br> RAL9016 Traffic white |
| Gasket               | Silicone rubber gasket  |
| Fasteners            | PCS Polymer Coated Stainless Steel Hardware   |
| Ingress protection   | IP66  |
| Impact resistance    | IK07  |
| Corrosion resistance | 5CE   |
| Windage              | 0.090 m <sup>2</sup>  |

---

**Electrical description**

---

|                  |   |
|------------------|---|
| Power supply     | 220-240V / 50-60 Hz   |
| Driver / Ballast | Standard. Optional DALI version available. To be specified at time of ordering. |
| Power factor     | > 0.9   |
| Surge protection | 6/6 kV (optional SP10)  |

---

**Additional information**

---

|          |                        |
|----------|------------------------|
| Lifetime | Ta=25° L90B10 > 90000h |
|----------|------------------------|

---

### Options

#### Light distribution



symmetric, medium beam [M]



symmetric, narrow beam [E]



symmetric, very narrow beam [EE]



symmetric, wide beam [B]



linear spread, very narrow beam [EE]



wallwash



symmetric, very narrow beam, sharp cut-off [EES]

#### Colour temperature



3000 K



4000 K



2700 K

#### Nominal Watt





0 W

72 W

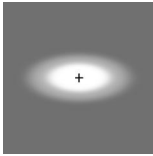

96 W

127 W

### Configurations

| Light distribution   | Part ID           | Light source                   | Rated lumens | Rated input power | CRI | Weight (kg) |
|--|-------------------|--------------------------------|--------------|-------------------|-----|-------------|
| linear spread, very narrow beam [EE]<br> | 139-1816+139-1855 | LED-24/48W / 700 mA - 3000 K   | 5947.8       | 54 W              | 80  | 12.60       |
|  | 139-1817+139-1855 | LED-24/48W / 700 mA - 4000 K   | 6358         | 54 W              | 80  | 12.60       |
|  | 139-1822+139-1855 | LED-24/72W / 1050 mA - 3000 K  | 8819.2       | 81 W              | 80  | 12.60       |
|  | 139-1823+139-1855 | LED-24/72W / 1050 mA - 4000 K  | 9229.4       | 81 W              | 80  | 12.60       |
|  | 139-1828+139-1855 | LED-24/104W / 1400 mA - 3000 K | 10850.7      | 112 W             | 80  | 12.60       |
|  | 139-1829+139-1855 | LED-24/104W / 1400 mA - 4000 K | 11343.9      | 112 W             | 80  | 12.60       |
|  | 139-2265+139-1855 | LED-24/48W / 700 mA - 2700 K   | 5537.7       | 54 W              | 80  | 12.60       |
|  | 139-2272+139-1855 | LED-24/72W / 1050 mA - 2700 K  | 8409         | 81 W              | 80  | 12.60       |
|  | 139-2278+139-1855 | LED-24/104W / 1400 mA - 2700 K | 10258.8      | 112 W             | 80  | 12.60       |
| symmetric, medium beam [M]<br>           | 139-1812          | LED-24/48W / 700 mA - 3000 K   | 6304.7       | 54 W              | 80  | 12.60       |
|  | 139-1813          | LED-24/48W / 700 mA - 4000 K   | 6739.5       | 54 W              | 80  | 12.60       |
|  | 139-1818          | LED-24/72W / 1050 mA - 3000 K  | 9348.3       | 81 W              | 80  | 12.60       |
|  | 139-1819          | LED-24/72W / 1050 mA - 4000 K  | 9783.1       | 81 W              | 80  | 12.60       |
|  | 139-1824          | LED-24/104W / 1400 mA - 3000 K | 11497.6      | 112 W             | 80  | 12.60       |
|  | 139-1825          | LED-24/104W / 1400 mA - 4000 K | 12020.2      | 112 W             | 80  | 12.60       |
|  | 139-2152          | LED-24/72W / 1050 mA - 2700 K  | 8913.5       | 81 W              | 80  | 12.60       |
|  | 139-2228          | LED-24/104W / 1400 mA - 2700 K | 10870.4      | 112 W             | 80  | 12.60       |
|  | 139-2252          | LED-24/48W / 700 mA - 2700 K   | 5869.9       | 54 W              | 80  | 12.60       |
| symmetric, narrow beam [E]<br>         | 139-1814          | LED-24/48W / 700 mA - 3000 K   | 5931         | 54 W              | 80  | 12.60       |
|  | 139-1815          | LED-24/48W / 700 mA - 4000 K   | 6340.1       | 54 W              | 80  | 12.60       |
|  | 139-1820          | LED-24/72W / 1050 mA - 3000 K  | 8794.3       | 81 W              | 80  | 12.60       |
|  | 139-1821          | LED-24/72W / 1050 mA - 4000 K  | 9203.3       | 81 W              | 80  | 12.60       |
|  | 139-1826          | LED-24/104W / 1400 mA - 3000 K | 10824.4      | 112 W             | 80  | 12.60       |
|  | 139-1827          | LED-24/104W / 1400 mA - 4000 K | 11316.5      | 112 W             | 80  | 12.60       |
|  | 139-2229          | LED-24/104W / 1400 mA - 2700 K | 10234        | 112 W             | 80  | 12.60       |
|  | 139-2250          | LED-24/72W / 1050 mA - 2700 K  | 8385.2       | 81 W              | 80  | 12.60       |
|  | 139-2253          | LED-24/48W / 700 mA - 2700 K   | 5522         | 54 W              | 80  | 12.60       |
| symmetric, very narrow beam [EE]<br>   | 139-1816          | LED-24/48W / 700 mA - 3000 K   | 6241         | 54 W              | 80  | 12.60       |
|  | 139-1817          | LED-24/48W / 700 mA - 4000 K   | 6671.5       | 54 W              | 80  | 12.60       |
|  | 139-1822          | LED-24/72W / 1050 mA - 3000 K  | 9254         | 81 W              | 80  | 12.60       |
|  | 139-1823          | LED-24/72W / 1050 mA - 4000 K  | 9684.4       | 81 W              | 80  | 12.60       |
|  | 139-1828          | LED-24/104W / 1400 mA - 3000 K | 11600.1      | 112 W             | 80  | 12.60       |
|  | 139-1829          | LED-24/104W / 1400 mA - 4000 K | 12127.4      | 112 W             | 80  | 12.60       |
|  | 139-2265          | LED-24/48W / 700 mA - 2700 K   | 5810.6       | 54 W              | 80  | 12.60       |
|  | 139-2272          | LED-24/72W / 1050 mA - 2700 K  | 8823.6       | 81 W              | 80  | 12.60       |

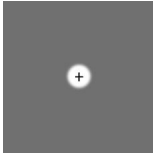
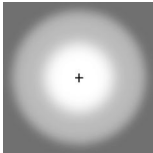
## Projectors

| Light distribution   | Part ID  | Light source                   | Rated lumens                 | Rated input power | CRI  | Weight (kg) |
|--|--|--------------------------------|------------------------------|-------------------|------|-------------|
| symmetric, very narrow beam, sharp cut-off [EES]<br> | 139-2278   | LED-24/104W / 1400 mA - 2700 K | 10967.4                      | 112 W             | 80   | 12.60       |
|  | 139-3137   | LED-48/72W / 500 mA - 2700 K   | 6498.9                       | 77 W              | 80   | 12.60       |
|  | 139-3138   | LED-48/72W / 500 mA - 3000 K   | 6947.1                       | 77 W              | 80   | 12.60       |
|  | 139-3139   | LED-48/72W / 500 mA - 4000 K   | 6947.1                       | 77 W              | 80   | 12.60       |
|  | 139-3141   | LED-48/96W / 700 mA - 2700 K   | 8515.8                       | 105.5 W           | 80   | 12.60       |
|  | 139-3142   | LED-48/96W / 700 mA - 3000 K   | 9188.2                       | 105.5 W           | 80   | 12.60       |
|  | 139-3143   | LED-48/96W / 700 mA - 4000 K   | 9188.2                       | 105.5 W           | 80   | 12.60       |
|  | 139-3145   | LED-48/127W / 900 mA - 2700 K  | 10308.7                      | 139 W             | 80   | 12.60       |
|  | 139-3146   | LED-48/127W / 900 mA - 3000 K  | 10981                        | 139 W             | 80   | 12.60       |
|  | 139-3147   | LED-48/127W / 900 mA - 4000 K  | 10981                        | 139 W             | 80   | 12.60       |
| symmetric, wide beam [B]<br>                         | 139-1921   | LED-24/48W / 700 mA - 3000 K   | 5981.4                       | 54 W              | 80   | 12.60       |
|  | 139-1922   | LED-24/48W / 700 mA - 4000 K   | 6393.9                       | 54 W              | 80   | 12.60       |
|  | 139-1923   | LED-24/72W / 1050 mA - 3000 K  | 8869                         | 81 W              | 80   | 12.60       |
|  | 139-1924   | LED-24/72W / 1050 mA - 4000 K  | 9281.5                       | 81 W              | 80   | 12.60       |
|  | 139-1925   | LED-24/104W / 1400 mA - 3000 K | 10960.8                      | 112 W             | 80   | 12.60       |
|  | 139-1926   | LED-24/104W / 1400 mA - 4000 K | 11459                        | 112 W             | 80   | 12.60       |
|  | 139-2227   | LED-24/104W / 1400 mA - 2700 K | 10362.9                      | 112 W             | 80   | 12.60       |
|  | 139-2249   | LED-24/72W / 1050 mA - 2700 K  | 8456.5                       | 81 W              | 80   | 12.60       |
|  | 139-2251   | LED-24/48W / 700 mA - 2700 K   | 5568.9                       | 54 W              | 80   | 12.60       |
|  | wallwash<br> | 139-1812+139-1854              | LED-24/48W / 700 mA - 3000 K | 5235.8            | 54 W | 80          |
| 139-1813+139-1854  |  | LED-24/48W / 700 mA - 4000 K   | 5596.9                       | 54 W              | 80   | 12.60       |
| 139-1818+139-1854  |  | LED-24/72W / 1050 mA - 3000 K  | 7763.5                       | 81 W              | 80   | 12.60       |
| 139-1819+139-1854  |  | LED-24/72W / 1050 mA - 4000 K  | 8124.5                       | 81 W              | 80   | 12.60       |
| 139-1824+139-1854  |  | LED-24/104W / 1400 mA - 3000 K | 9548.2                       | 112 W             | 80   | 12.60       |
| 139-1825+139-1854  |  | LED-24/104W / 1400 mA - 4000 K | 9982.2                       | 112 W             | 80   | 12.60       |
| 139-2152+139-1854  |  | LED-24/72W / 1050 mA - 2700 K  | 7402.4                       | 81 W              | 80   | 12.60       |
| 139-2228+139-1854  |  | LED-24/104W / 1400 mA - 2700 K | 9027.4                       | 112 W             | 80   | 12.60       |
| 139-2252+139-1854  |  | LED-24/48W / 700 mA - 2700 K   | 4874.7                       | 54 W              | 80   | 12.60       |

**Mounting Accessories**

**Short post EM**

| Description | Part ID  | D1  | D2  | H1  | M1 | Weight (kg) |
|-------------|----------|-----|-----|-----|----|-------------|
| EM1-M16 AL  | 270-9038 | 160 | 130 | 203 | 9  | 2           |

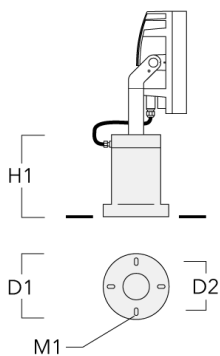

**Floodlight mounting bracket TA**

| Description                                | Part ID  | A | C1  | D x L1   | Weight (kg) | D x S    |
|--|----------|---|-----|----------|-------------|----------|
| TA1 Mounting bracket, single* (Ø 76 x 200) | 147-0023 |   | 130 | 76 x 200 | 1.90        | 76 x 200 |

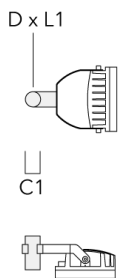

**Projectors**

| Description                                | Part ID  | A | C1  | D × L1   | Weight (kg) | D × S    |
|--|----------|---|-----|----------|-------------|----------|
| TA2 Mounting bracket, double* (Ø 76 x 200) | 147-0024 |   | 130 | 76 x 200 | 1.90        | 76 x 200 |

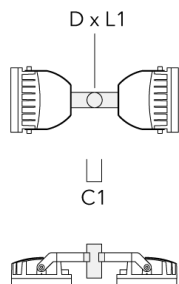

|   |          |      |     |          |       |          |
|---|----------|------|-----|----------|-------|----------|
| TA2-L Mounting bracket, double (Ø 76 x 200) | 147-0105 | ±90° | 420 | 76 x 200 | 16.10 | 76 x 200 |
|---|----------|------|-----|----------|-------|----------|

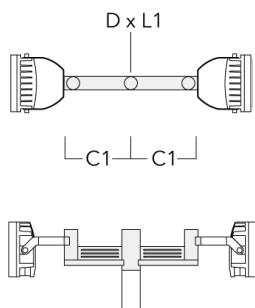

## Projectors

| Description                               | Part ID  | A    | C1  | D x L1   | Weight (kg) | D x S    |
|---|----------|------|-----|----------|-------------|----------|
| TA3 Mounting bracket, triple (Ø 89 x 200) | 147-0025 | ±90° | 650 | 89 x 200 | 17.90       | 89 x 200 |

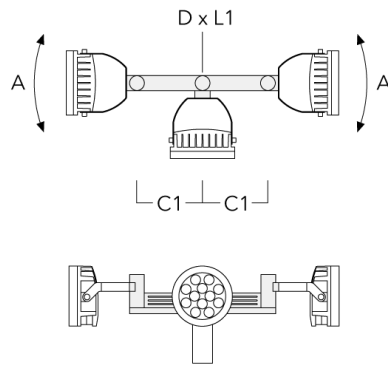

|   |          |      |     |          |       |          |
|---|----------|------|-----|----------|-------|----------|
| TA4 Mounting bracket, quad (Ø 89 x 200) | 147-0099 | ±90° | 650 | 89 x 200 | 20.80 | 89 x 200 |
|---|----------|------|-----|----------|-------|----------|

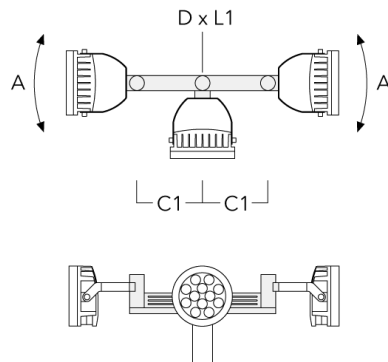



| Description                                | Part ID  | A | C1  | D × L1    | Weight (kg) | D × S     |
|--|----------|---|-----|-----------|-------------|-----------|
| TA1 Mounting bracket, single (Ø 108 x 200) | 147-0096 |   | 130 | 108 x 200 | 7.50        | 108 x 200 |

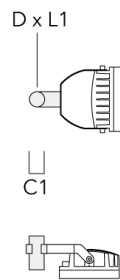

|  |          |  |     |           |      |           |
|--|----------|--|-----|-----------|------|-----------|
| TA2 Mounting bracket, double (Ø 108 x 200) | 147-0097 |  | 130 | 108 x 200 | 7.50 | 108 x 200 |
|--|----------|--|-----|-----------|------|-----------|

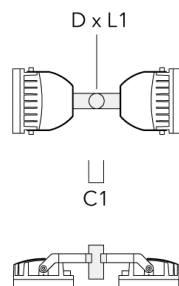

| Description                                  | Part ID  | A    | C1  | D x L1    | Weight (kg) | D x S     |
|--|----------|------|-----|-----------|-------------|-----------|
| TA2-L Mounting bracket, double (Ø 108 x 200) | 147-0148 | ±90° | 420 | 108 x 200 | 20.20       | 108 x 200 |

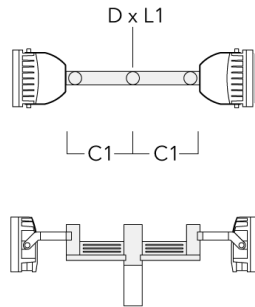

|  |          |      |     |           |       |           |
|--|----------|------|-----|-----------|-------|-----------|
| TA3 Mounting bracket, triple (Ø 108 x 200) | 147-0098 | ±90° | 650 | 108 x 200 | 24.20 | 108 x 200 |
|--|----------|------|-----|-----------|-------|-----------|

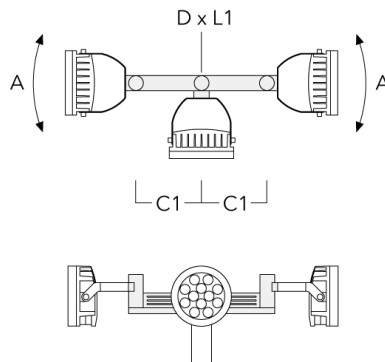

| Description                              | Part ID  | A    | C1  | D × L1    | Weight (kg) | D × S     |
|--|----------|------|-----|-----------|-------------|-----------|
| TA4 Mounting bracket, quad (Ø 108 x 200) | 147-0100 | ±90° | 650 | 108 x 200 | 24.20       | 108 x 200 |

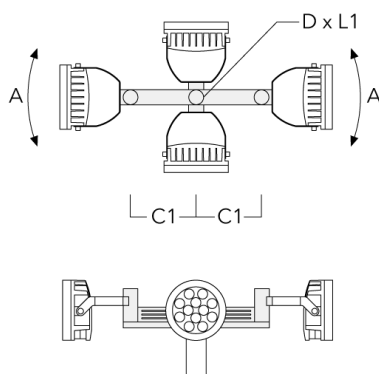

## Pole clamp TS

| Description                            | Part ID  | D1    | Weight (kg) | D     |
|--|----------|-------|-------------|-------|
| TS1-2/M12 Pole clamp, single (Ø 76-89) | 147-0543 | 76-89 | 1.40        | 76-89 |

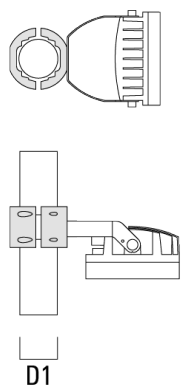

| Description                              | Part ID  | D1      | Weight (kg) | D       |
|--|----------|---------|-------------|---------|
| TS1-2/M12 Pole clamp, single (Ø 102-114) | 147-0526 | 102-114 | 1.50        | 102-114 |

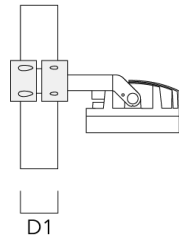
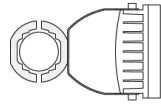

|  |          |         |      |         |
|--|----------|---------|------|---------|
| TS1-2/M12 Pole clamp, single (Ø 114-133) | 147-0544 | 114-133 | 1.70 | 114-133 |
|--|----------|---------|------|---------|

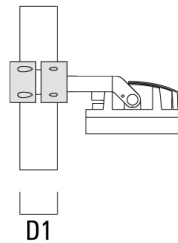
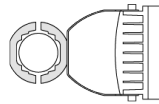

**Projectors**

| Description                            | Part ID  | D1    | Weight (kg) | D     |
|--|----------|-------|-------------|-------|
| TS2-2/M12 Pole clamp, double (Ø 76-89) | 147-0545 | 76-89 | 1.40        | 76-89 |

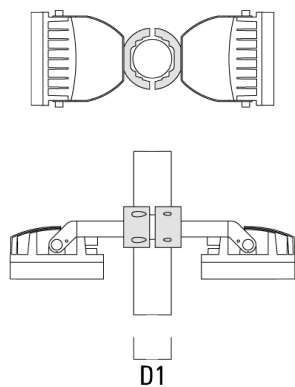

|  |          |         |      |         |
|--|----------|---------|------|---------|
| TS2-2/M12 Pole clamp, double (Ø 102-114) | 147-0527 | 102-114 | 1.50 | 102-114 |
|--|----------|---------|------|---------|

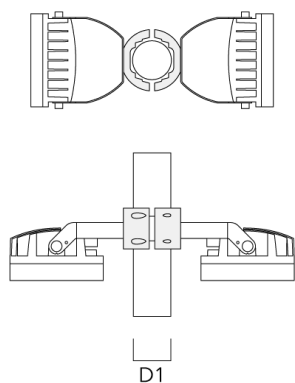

| Description                              | Part ID  | D1      | Weight (kg) | D       |
|--|----------|---------|-------------|---------|
| TS2-2/M12 Pole clamp, double (Ø 114-133) | 147-0546 | 114-133 | 1.60        | 114-133 |

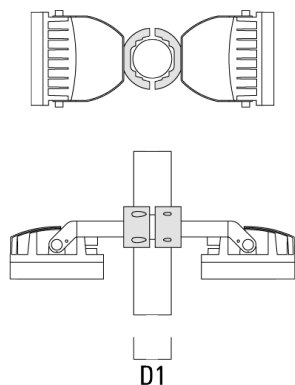

### Planted root

| Description       | Part ID  | D1  | D2  | D3  | D4  | H1  | H2  | M1 | Weight (kg) |
|-------------------|----------|-----|-----|-----|-----|-----|-----|----|-------------|
| Planted root ESV4 | 300-0461 | 145 | 130 | 102 | 108 | 400 | 350 | 8  | 7.05        |

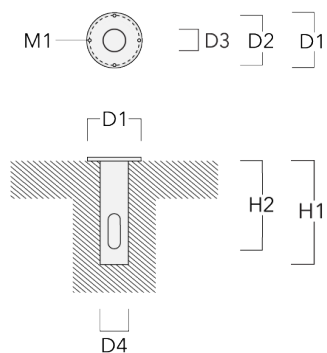

### Pole clamp PC

#### WE-EF LEUCHTEN GmbH

Töpinger Straße 16, 29646 Bispingen, Germany - Phone: +49 5194 909-0

info@we-ef.com - <https://we-ef.com>

Subject to technical changes and errors. - Generated on 23/10/2024

| Description                               | Part ID  | D1    | Weight (kg) |
|---|----------|-------|-------------|
| PC2 76-89/60 Pole clamp, double (Ø 76-89) | 139-2703 | 76-89 | 1.00        |



|   |          |       |      |
|---|----------|-------|------|
| PC1 76-89/60 Pole clamp, single (Ø 76-89) | 139-2702 | 76-89 | 1.00 |
|---|----------|-------|------|



| Description                                      | Part ID  | D1      | Weight (kg) |
|--|----------|---------|-------------|
| PC2 102-114/60 Pole clamp, double<br>(Ø 102-114) | 139-2707 | 102-114 | 1.20        |

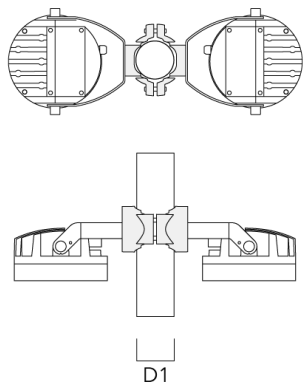

|  |          |         |      |
|--|----------|---------|------|
| PC1 102-114/60 Pole clamp, single<br>(Ø 102-114) | 139-2706 | 102-114 | 1.20 |
|--|----------|---------|------|

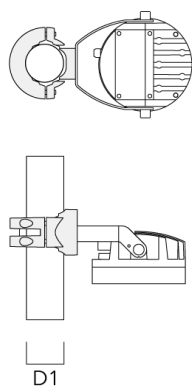



| Description                                      | Part ID  | D1      | Weight (kg) |
|--|----------|---------|-------------|
| PC2 114-133/60 Pole clamp, double<br>(Ø 114-133) | 139-2709 | 114-133 | 1.40        |



|  |          |         |      |
|--|----------|---------|------|
| PC1 114-133/60 Pole clamp, single<br>(Ø 114-133) | 139-2708 | 114-133 | 1.40 |
|--|----------|---------|------|



| Description                                | Part ID  | D1     | Weight (kg) |
|--|----------|--------|-------------|
| PC2 82-109/60 Pole camp, double (Ø 82-109) | 139-2705 | 82-109 | 1.10        |

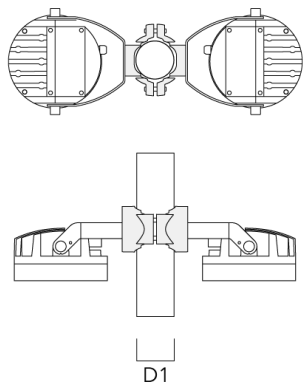

**Control****Eco Step Dim® Basic**

| Description             | Part ID  |
|-------------------------|----------|
| Eco Step Dim® Basic LED | 430-0001 |

**Eco Step Dim® Advanced**

| Description                | Part ID  |
|----------------------------|----------|
| Eco Step Dim® Advanced LED | 430-0002 |

**R2C Ready to Connect**

| Description                | Part ID  |
|----------------------------|----------|
| R2C Ready to Connect (top) | 430-0019 |

**Optical Accessories****Flood lens**

| Description       | Part ID  | C1  |
|-------------------|----------|-----|
| IO-360-FLC240-LED | 139-1856 | 289 |

**Honeycomb louvre**

| Description         | Part ID  | C1  |
|---------------------|----------|-----|
| Honeycomb Louvre IW | 139-1857 | 279 |

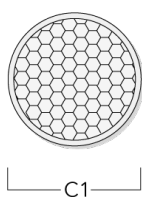
**Snoot****WE-EF LEUCHTEN GmbH**

Töpingen Straße 16, 29646 Bispingen, Germany - Phone: +49 5194 909-0

info@we-ef.com - <https://we-ef.com>

Subject to technical changes and errors. - Generated on 23/10/2024

## Projectors

| Description   | Part ID  | A   | C1  |
|---------------|----------|-----|-----|
| ET-FLC240-LED | 139-1859 | 200 | 346 |

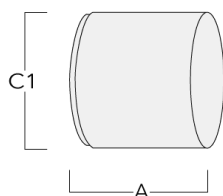

## Glare shield

| Description   | Part ID  | A   | C1  |
|---------------|----------|-----|-----|
| ES-FLC240-LED | 139-1858 | 200 | 346 |

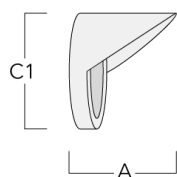

## Wallwash lens

### WE-EF LEUCHTEN GmbH

Töpinger Straße 16, 29646 Bispingen, Germany - Phone: +49 5194 909-0

info@we-ef.com - <https://we-ef.com>

Subject to technical changes and errors. - Generated on 23/10/2024

---

| Description      | Part ID  | Additional information                       | C1  |
|------------------|----------|--|-----|
| IO-20-FLC240-LED | 139-1854 | for symmetric [M] medium beam luminaire only | 289 |

---

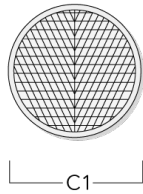

---

**Linear spread lens**

---

| Description               | Part ID  | C1  |
|---------------------------|----------|-----|
| Linear spread lens IO-180 | 139-1855 | 289 |

---

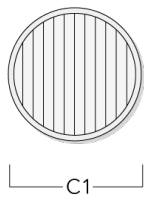

**FLC240 LED**

**Projectors**

**WE-EF LEUCHTEN GmbH**

Töpinger Straße 16, 29646 Bispingen, Germany

Phone: +49 5194 909-0

[info@we-ef.com](mailto:info@we-ef.com)

<https://we-ef.com>

Subject to technical changes and errors.

Generated on 23/10/2024