





Description

IP66, Class I. Class II on request. IK07. Marine-grade, die-cast aluminium alloy. 5CE superior corrosion protection including PCS hardware. Silicone CCG® Controlled Compression Gasket. Safety glass lens. One cable gland. Second gland for through wiring on request. Integral EC electronic converter, thermally separated. CAD-optimised optics for superior illumination and glare control. OLC® One LED Concept. Factory installed LED circuit board. 1-10V, DALI Interface or Eco Step Dim® on request. Maximum one internal optical accessory possible.

Optional 2200 K version up to max. 1050mA available, except version [EES]. To be specified at time of ordering.

Specifications

Material description

Body	Marine-grade, die-cast aluminium alloy
Lens	Safety glass lens
Colours	<div style="display: flex; flex-direction: column; gap: 5px;"> <div> RAL9004 Signal black</div> <div> RAL9006 White aluminium</div> <div> RAL9007 Grey aluminium</div> <div> RAL7016 Anthracite grey</div> <div> RAL9016 Traffic white</div> </div>
Gasket	Silicone rubber gasket
Fasteners	PCS Polymer Coated Stainless Steel Hardware
Ingress protection	IP66
Impact resistance	IK07
Corrosion resistance	5CE
Windage	0.090 m ²

Electrical description







Power supply	220-240V / 50-60 Hz
Driver / Ballast	Standard. Optional DALI version available. To be specified at time of ordering.
Power factor	> 0.9
Surge protection	6/6 kV (optional SP10)

Additional information



Lifetime	Ta=25° L90B10 > 90000h
----------	------------------------

Options

Light distribution

	symmetric, medium beam [M]
	symmetric, narrow beam [E]
	symmetric, very narrow beam [EE]
	symmetric, wide beam [B]
	linear spread, very narrow beam [EE]
	wallwash
	symmetric, very narrow beam, sharp cut-off [EES]



Colour temperature

	3000 K
	4000 K
	2700 K

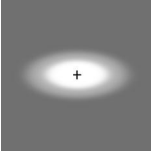

Nominal Watt

0 W
72 W
96 W
127 W

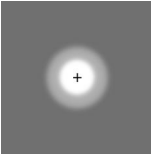
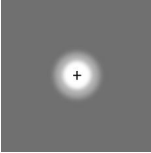
Configurations

Light distribution	Part ID	Light source	Rated lumens	Rated input power	CRI	Weight (kg)
linear spread, very narrow beam [EE] 	139-1816+139-1855	LED-24/48W / 700 mA - 3000 K	5947.8	54 W	80	12.60
	139-1817+139-1855	LED-24/48W / 700 mA - 4000 K	6358	54 W	80	12.60
	139-1822+139-1855	LED-24/72W / 1050 mA - 3000 K	8819.2	79 W	80	12.60
	139-1823+139-1855	LED-24/72W / 1050 mA - 4000 K	9229.4	79 W	80	12.60
	139-1828+139-1855	LED-24/104W / 1400 mA - 3000 K	10850.7	106 W	80	12.60
	139-1829+139-1855	LED-24/104W / 1400 mA - 4000 K	11343.9	106 W	80	12.60
	139-2265+139-1855	LED-24/48W / 700 mA - 2700 K	5537.7	54 W	80	12.60
	139-2272+139-1855	LED-24/72W / 1050 mA - 2700 K	8409	79 W	80	12.60
	139-2278+139-1855	LED-24/104W / 1400 mA - 2700 K	10258.8	106 W	80	12.60
symmetric, medium beam [M] 	139-1812	LED-24/48W / 700 mA - 3000 K	6304.7	54 W	80	12.60
	139-1813	LED-24/48W / 700 mA - 4000 K	6739.5	54 W	80	12.60
	139-1818	LED-24/72W / 1050 mA - 3000 K	9348.3	79 W	80	12.60
	139-1819	LED-24/72W / 1050 mA - 4000 K	9783.1	79 W	80	12.60
	139-1824	LED-24/104W / 1400 mA - 3000 K	11497.6	106 W	80	12.60
	139-1825	LED-24/104W / 1400 mA - 4000 K	12020.2	106 W	80	12.60
	139-2152	LED-24/72W / 1050 mA - 2700 K	8913.5	79 W	80	12.60
	139-2228	LED-24/104W / 1400 mA - 2700 K	10870.4	106 W	80	12.60
	139-2252	LED-24/48W / 700 mA - 2700 K	5869.9	54 W	80	12.60
symmetric, narrow beam [E] 	139-1814	LED-24/48W / 700 mA - 3000 K	5931	54 W	80	12.60
	139-1815	LED-24/48W / 700 mA - 4000 K	6340.1	54 W	80	12.60
	139-1820	LED-24/72W / 1050 mA - 3000 K	8794.3	79 W	80	12.60
	139-1821	LED-24/72W / 1050 mA - 4000 K	9203.3	79 W	80	12.60
	139-1826	LED-24/104W / 1400 mA - 3000 K	10824.4	106 W	80	12.60
	139-1827	LED-24/104W / 1400 mA - 4000 K	11316.5	106 W	80	12.60
	139-2229	LED-24/104W / 1400 mA - 2700 K	10234	106 W	80	12.60
	139-2250	LED-24/72W / 1050 mA - 2700 K	8385.2	79 W	80	12.60
	139-2253	LED-24/48W / 700 mA - 2700 K	5522	54 W	80	12.60
symmetric, very narrow beam [EE] 	139-1816	LED-24/48W / 700 mA - 3000 K	6241	54 W	80	12.60
	139-1817	LED-24/48W / 700 mA - 4000 K	6671.5	54 W	80	12.60
	139-1822	LED-24/72W / 1050 mA - 3000 K	9254	79 W	80	12.60
	139-1823	LED-24/72W / 1050 mA - 4000 K	9684.4	79 W	80	12.60
	139-1828	LED-24/104W / 1400 mA - 3000 K	11600.1	106 W	80	12.60
	139-1829	LED-24/104W / 1400 mA - 4000 K	12127.4	106 W	80	12.60
	139-2265	LED-24/48W / 700 mA - 2700 K	5810.6	54 W	80	12.60

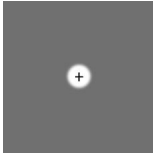
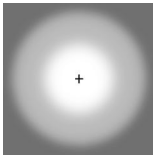
Projectors

Light distribution	Part ID	Light source	Rated lumens	Rated input power	CRI	Weight (kg)
symmetric, very narrow beam, sharp cut-off [EES] 	139-2272	LED-24/72W / 1050 mA - 2700 K	8823.6	79 W	80	12.60
	139-2278	LED-24/104W / 1400 mA - 2700 K	10967.4	106 W	80	12.60
	139-3137	LED-48/72W / 500 mA - 2700 K	6498.9	77 W	80	12.60
	139-3138	LED-48/72W / 500 mA - 3000 K	6947.1	77 W	80	12.60
	139-3139	LED-48/72W / 500 mA - 4000 K	6947.1	77 W	80	12.60
	139-3141	LED-48/96W / 700 mA - 2700 K	8515.8	105.5 W	80	12.60
	139-3142	LED-48/96W / 700 mA - 3000 K	9188.2	105.5 W	80	12.60
	139-3143	LED-48/96W / 700 mA - 4000 K	9188.2	105.5 W	80	12.60
	139-3145	LED-48/127W / 900 mA - 2700 K	10308.7	139 W	80	12.60
	139-3146	LED-48/127W / 900 mA - 3000 K	10981	139 W	80	12.60
139-3147	LED-48/127W / 900 mA - 4000 K	10981	139 W	80	12.60	
symmetric, wide beam [B] 	139-1921	LED-24/48W / 700 mA - 3000 K	5981.4	54 W	80	12.60
	139-1922	LED-24/48W / 700 mA - 4000 K	6393.9	54 W	80	12.60
	139-1923	LED-24/72W / 1050 mA - 3000 K	8869	79 W	80	12.60
	139-1924	LED-24/72W / 1050 mA - 4000 K	9281.5	79 W	80	12.60
	139-1925	LED-24/104W / 1400 mA - 3000 K	10960.8	106 W	80	12.60
	139-1926	LED-24/104W / 1400 mA - 4000 K	11459	106 W	80	12.60
	139-2227	LED-24/104W / 1400 mA - 2700 K	10362.9	106 W	80	12.60
	139-2249	LED-24/72W / 1050 mA - 2700 K	8456.5	79 W	80	12.60
	139-2251	LED-24/48W / 700 mA - 2700 K	5568.9	54 W	80	12.60
	wallwash 	139-1812+139-1854	LED-24/48W / 700 mA - 3000 K	5235.8	54 W	80
139-1813+139-1854		LED-24/48W / 700 mA - 4000 K	5596.9	54 W	80	12.60
139-1818+139-1854		LED-24/72W / 1050 mA - 3000 K	7763.5	79 W	80	12.60
139-1819+139-1854		LED-24/72W / 1050 mA - 4000 K	8124.5	79 W	80	12.60
139-1824+139-1854		LED-24/104W / 1400 mA - 3000 K	9548.2	106 W	80	12.60
139-1825+139-1854		LED-24/104W / 1400 mA - 4000 K	9982.2	106 W	80	12.60
139-2152+139-1854		LED-24/72W / 1050 mA - 2700 K	7402.4	79 W	80	12.60
139-2228+139-1854		LED-24/104W / 1400 mA - 2700 K	9027.4	106 W	80	12.60
139-2252+139-1854		LED-24/48W / 700 mA - 2700 K	4874.7	54 W	80	12.60

Mounting Accessories

Short post EM

Description	Part ID	D1	D2	H1	M1	Weight (kg)
EM1-M16 AL	270-9038	160	130	203	9	2

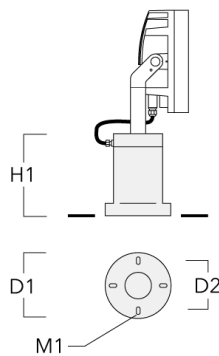

Floodlight mounting bracket TA

Description	Part ID	A	C1	D x L1	Weight (kg)	D x S
TA1 Mounting bracket, single* (Ø 76 x 200)	147-0023		130	76 x 200	1.90	76 x 200

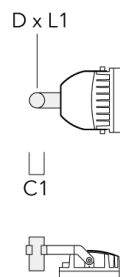

Projectors

Description	Part ID	A	C1	D x L1	Weight (kg)	D x S
TA2 Mounting bracket, double* (Ø 76 x 200)	147-0024		130	76 x 200	1.90	76 x 200

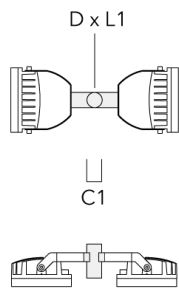

TA2-L Mounting bracket, double (Ø 76 x 200)	147-0105	±90°	420	76 x 200	16.10	76 x 200
---	----------	------	-----	----------	-------	----------

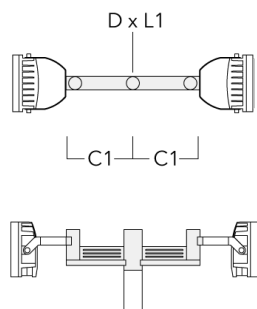

Projectors

Description	Part ID	A	C1	D x L1	Weight (kg)	D x S
TA3 Mounting bracket, triple (Ø 89 x 200)	147-0025	±90°	650	89 x 200	17.90	89 x 200

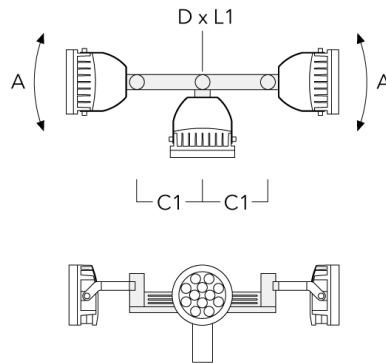

TA4 Mounting bracket, quad (Ø 89 x 200)	147-0099	±90°	650	89 x 200	20.80	89 x 200
---	----------	------	-----	----------	-------	----------

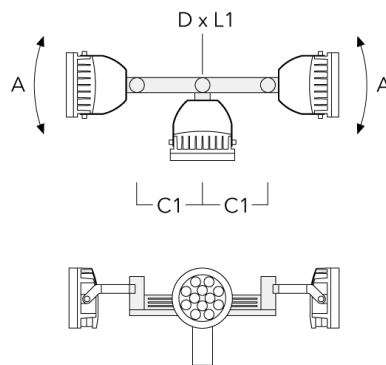

Projectors

Description	Part ID	A	C1	D × L1	Weight (kg)	D × S
TA1 Mounting bracket, single (Ø 108 x 200)	147-0096		130	108 x 200	7.50	108 x 200

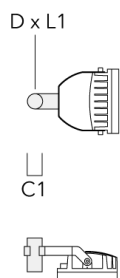

TA2 Mounting bracket, double (Ø 108 x 200)	147-0097		130	108 x 200	7.50	108 x 200
--	----------	--	-----	-----------	------	-----------

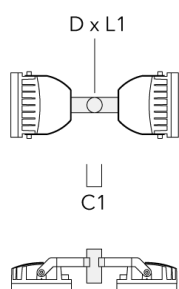

Projectors

Description	Part ID	A	C1	D x L1	Weight (kg)	D x S
TA2-L Mounting bracket, double (Ø 108 x 200)	147-0148	±90°	420	108 x 200	20.20	108 x 200

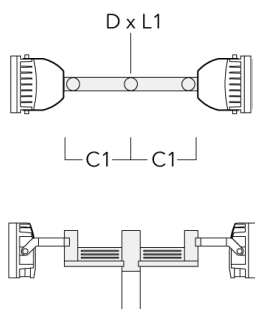

TA3 Mounting bracket, triple (Ø 108 x 200)	147-0098	±90°	650	108 x 200	24.20	108 x 200
--	----------	------	-----	-----------	-------	-----------

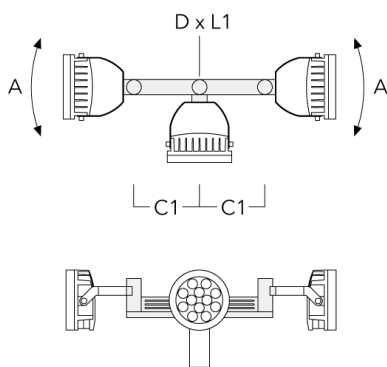

Projectors

Description	Part ID	A	C1	D × L1	Weight (kg)	D × S
TA4 Mounting bracket, quad (Ø 108 x 200)	147-0100	±90°	650	108 x 200	24.20	108 x 200

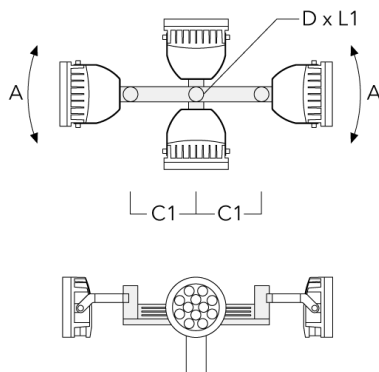

Pole clamp TS

Description	Part ID	D1	Weight (kg)	D
TS1-2/M12 Pole clamp, single (Ø 76-89)	147-0543	76-89	1.40	76-89

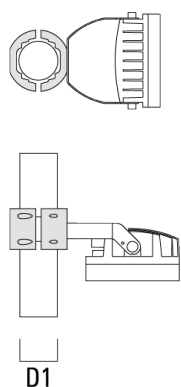

Projectors

Description	Part ID	D1	Weight (kg)	D
TS1-2/M12 Pole clamp, single (Ø 102-114)	147-0526	102-114	1.50	102-114

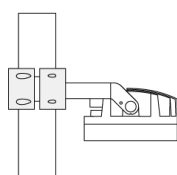
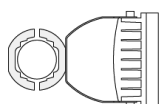

D1

TS1-2/M12 Pole clamp, single (Ø 114-133)	147-0544	114-133	1.70	114-133
--	----------	---------	------	---------

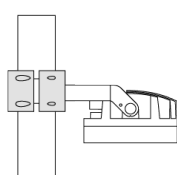
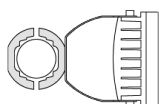

D1

Projectors

Description	Part ID	D1	Weight (kg)	D
TS2-2/M12 Pole clamp, double (Ø 76-89)	147-0545	76-89	1.40	76-89

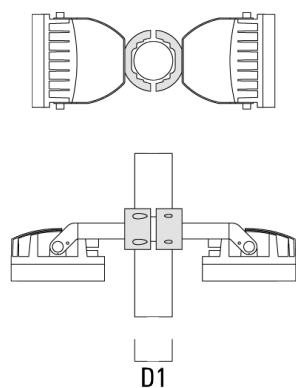

TS2-2/M12 Pole clamp, double (Ø 102-114)	147-0527	102-114	1.50	102-114
--	----------	---------	------	---------

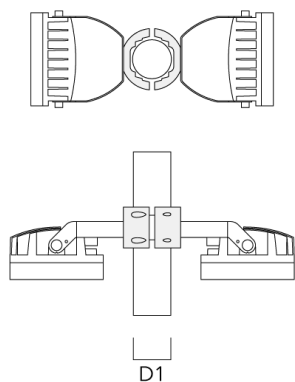

Projectors

Description	Part ID	D1	Weight (kg)	D
TS2-2/M12 Pole clamp, double (Ø 114-133)	147-0546	114-133	1.60	114-133

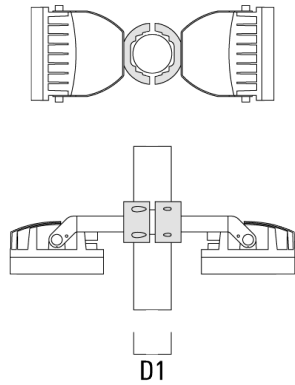

Planted root

Description	Part ID	D1	D2	D3	D4	H1	H2	M1	Weight (kg)
Planted root ESV4	300-0461	145	130	102	108	400	350	8	7.05

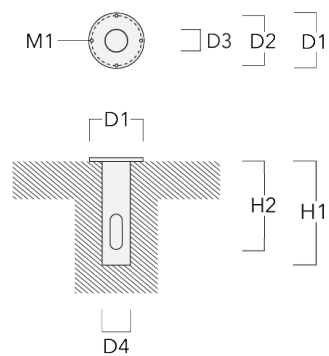

Pole clamp PC

Description	Part ID	D1	Weight (kg)
PC2 76-89/60 Pole clamp, double (Ø 76-89)	139-2703	76-89	1.00

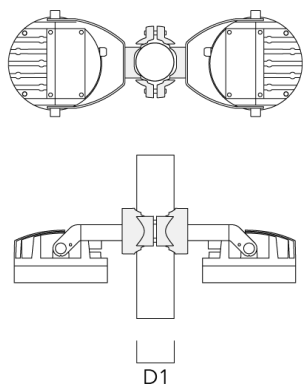

PC1 76-89/60 Pole clamp, single (Ø 76-89)	139-2702	76-89	1.00
---	----------	-------	------

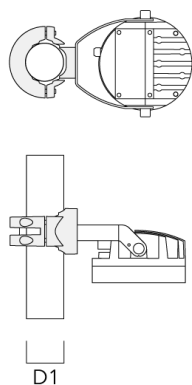

Projectors

Description	Part ID	D1	Weight (kg)
PC2 102-114/60 Pole clamp, double (Ø 102-114)	139-2707	102-114	1.20

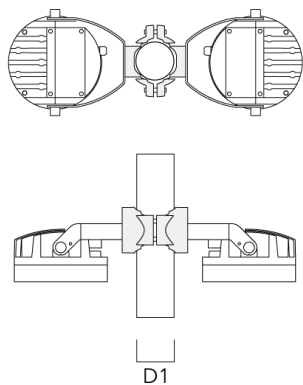

PC1 102-114/60 Pole clamp, single (Ø 102-114)	139-2706	102-114	1.20
--	----------	---------	------

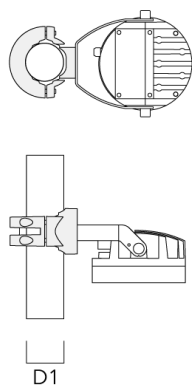

Projectors

Description	Part ID	D1	Weight (kg)
PC2 114-133/60 Pole clamp, double (Ø 114-133)	139-2709	114-133	1.40

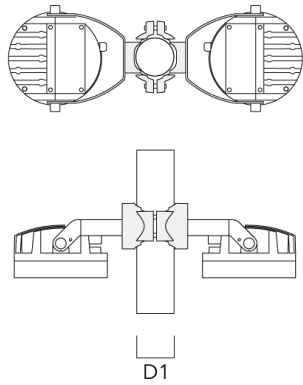

PC1 114-133/60 Pole clamp, single (Ø 114-133)	139-2708	114-133	1.40
--	----------	---------	------

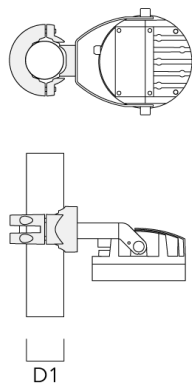

Projectors

Description	Part ID	D1	Weight (kg)
PC2 82-109/60 Pole camp, double (Ø 82-109)	139-2705	82-109	1.10

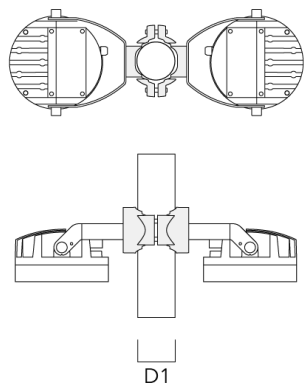

PC1 82-109/60 Pole camp, single (Ø 82-109)	139-2704	82-109	1.10
--	----------	--------	------

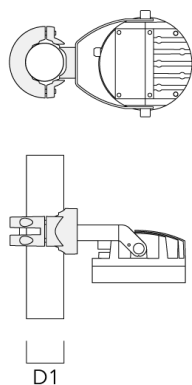

Projectors

Control**Eco Step Dim® Basic**

Description	Part ID
Eco Step Dim® Basic LED	430-0001

Eco Step Dim® Advanced

Description	Part ID
Eco Step Dim® Advanced LED	430-0002

R2C Ready to Connect

Description	Part ID
R2C Ready to Connect (top)	430-0019

Optical Accessories

Flood lens

Description	Part ID	C1
IO-360-FLC240-LED	139-1856	289

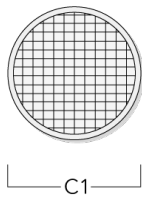

Honeycomb louvre

Description	Part ID	C1
Honeycomb Louvre IW	139-1857	279

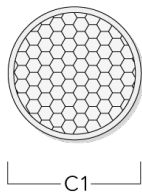

Projectors

Snoot

Description	Part ID	A	C1
ET-FLC240-LED	139-1859	200	346

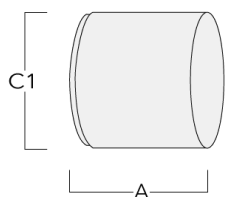

Glare shield

Description	Part ID	A	C1
ES-FLC240-LED	139-1858	200	346

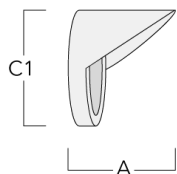

Projectors

Wallwash lens

Description	Part ID	Additional information	C1
IO-20-FLC240-LED	139-1854	for symmetric [M] medium beam luminaire only	289

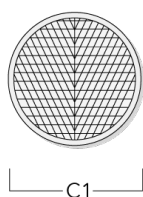

Linear spread lens

Description	Part ID	C1
Linear spread lens IO-180	139-1855	289

