



**Beschreibung**

IP66, SKI. SKII auf Anfrage. IK07. Korrosionsbeständiger Aluminiumguss. PCS beschichtete Edelstahlschrauben. 5CE Korrosionsschutz. CCG® Controlled Compression Gasket Silikondichtung. Sicherheitsglas. Eine Kabelverschraubung, eine zweite Kabelverschraubung zur Durchverdrahtung auf Anfrage. Eingebaute elektronische Betriebsgeräte, thermisch getrennt. CAD optimierte OLC® One LED Concept Technik zur Lichtlenkung und Entblendung. Eingebaute LED Platine. 1-10V, DALI Schnittstelle oder Eco Step Dim® auf Anfrage. Maximal ein internes Zubehörteil möglich. Variante mit 2200 K bis max. 1050 mA erhältlich, nicht für [EES] Version. Bei Bestellung bitte angeben.

**Spezifikationen****Materialbeschreibung**

---

Gehäuse	Korrosionsbeständiger Aluminiumguss
Abdeckung	Sicherheitsglasscheibe
Farben	 RAL9004 Signalschwarz  RAL9007 Graualuminium  RAL7016 Anthrazitgrau  RAL9016 Verkehrsweiß
Dichtung	Silikondichtung
Schrauben	PCS beschichtete Edelstahlschrauben
Schutzart	IP66
Schlagfestigkeit	IK07
Korrosionsbeständigkeit	5CE
Windangriffsfläche	0.090 m <sup>2</sup>

---

**Elektrische Beschreibung**

---

Netzgerät / Vorschaltgerät	Standard. Variante mit DALI erhältlich, bei Bestellung bitte angeben.
Leistungsfaktor	> 0.9
Überspannungsschutz	6 kV (optional SP10)

---

**Weitere Informationen**

---

Lebensdauer	Ta=25° L90B10 > 90000h
-------------	------------------------

---

### Auswahl

#### Lichtverteilung



symmetrisch mediumstrahlend [M]



symmetric, narrow beam [E]



symmetrisch extrem engstrahlend [EE]



symmetrisch breitstrahlend [B]



bandförmig extrem engstrahlend [EE]



wallwash



symmetrisch extrem engstrahlend, 'sharp cut-off' [EES]

#### Farbtemperaturen



3000 K



4000 K



2700 K

#### Nominal Watt

0 W

72 W



96 W

127 W

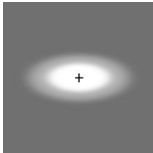
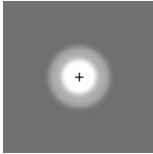
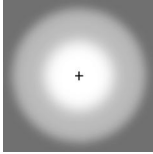
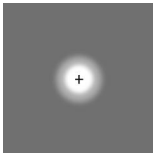
### Konfigurationen

Lichtverteilung	Artikelnummer	Lichtquelle	Bemes- sungslicht- strom	Bemes- sungsleis- tung	CRI	Gewicht (kg)	
bandförmig extrem engstrahlend [EE] 	139-1816+139-1855	LED-24/48W / 700 mA - 3000 K	5947.8	54 W	80	12.60	
	139-1817+139-1855	LED-24/48W / 700 mA - 4000 K	6358	54 W	80	12.60	
	139-1822+139-1855	LED-24/72W / 1050 mA - 3000 K	8819.2	81 W	80	12.60	
	139-1823+139-1855	LED-24/72W / 1050 mA - 4000 K	9229.4	81 W	80	12.60	
	139-1828+139-1855	LED-24/104W / 1400 mA - 3000 K	10850.7	112 W	80	12.60	
	139-1829+139-1855	LED-24/104W / 1400 mA - 4000 K	11343.9	112 W	80	12.60	
	139-2265+139-1855	LED-24/48W / 700 mA - 2700 K	5537.7	54 W	80	12.60	
	139-2272+139-1855	LED-24/72W / 1050 mA - 2700 K	8409	81 W	80	12.60	
	139-2278+139-1855	LED-24/104W / 1400 mA - 2700 K	10258.8	112 W	80	12.60	
symmetric, narrow beam [E] 	139-1814	LED-24/48W / 700 mA - 3000 K	5931	54 W	80	12.60	
	139-1815	LED-24/48W / 700 mA - 4000 K	6340.1	54 W	80	12.60	
	139-1820	LED-24/72W / 1050 mA - 3000 K	8794.3	81 W	80	12.60	
	139-1821	LED-24/72W / 1050 mA - 4000 K	9203.3	81 W	80	12.60	
	139-1826	LED-24/104W / 1400 mA - 3000 K	10824.4	112 W	80	12.60	
	139-1827	LED-24/104W / 1400 mA - 4000 K	11316.5	112 W	80	12.60	
	139-2229	LED-24/104W / 1400 mA - 2700 K	10234	112 W	80	12.60	
	139-2250	LED-24/72W / 1050 mA - 2700 K	8385.2	81 W	80	12.60	
	139-2253	LED-24/48W / 700 mA - 2700 K	5522	54 W	80	12.60	
symmetrisch breitstrahlend [B] 	139-1921	LED-24/48W / 700 mA - 3000 K	5981.4	54 W	80	12.60	
	139-1922	LED-24/48W / 700 mA - 4000 K	6393.9	54 W	80	12.60	
	139-1923	LED-24/72W / 1050 mA - 3000 K	8869	81 W	80	12.60	
	139-1924	LED-24/72W / 1050 mA - 4000 K	9281.5	81 W	80	12.60	
	139-1925	LED-24/104W / 1400 mA - 3000 K	10960.8	112 W	80	12.60	
	139-1926	LED-24/104W / 1400 mA - 4000 K	11459	112 W	80	12.60	
	139-2227	LED-24/104W / 1400 mA - 2700 K	10362.9	112 W	80	12.60	
	139-2249	LED-24/72W / 1050 mA - 2700 K	8456.5	81 W	80	12.60	
	139-2251	LED-24/48W / 700 mA - 2700 K	5568.9	54 W	80	12.60	
	symmetrisch extrem engstrahlend [EE] 	139-1816	LED-24/48W / 700 mA - 3000 K	6241	54 W	80	12.60
		139-1817	LED-24/48W / 700 mA - 4000 K	6671.5	54 W	80	12.60
139-1822		LED-24/72W / 1050 mA - 3000 K	9254	81 W	80	12.60	
139-1823		LED-24/72W / 1050 mA - 4000 K	9684.4	81 W	80	12.60	
139-1828		LED-24/104W / 1400 mA - 3000 K	11600.1	112 W	80	12.60	
139-1829		LED-24/104W / 1400 mA - 4000 K	12127.4	112 W	80	12.60	
139-2265		LED-24/48W / 700 mA - 2700 K	5810.6	54 W	80	12.60	

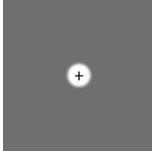
## Scheinwerfer symmetrisch

Lichtverteilung	Artikelnummer	Lichtquelle	Bemes- sungslicht- strom	Bemes- sungsleis- tung	CRI	Gewicht (kg)
symmetrisch extrem engstrahlend, 'sharp cut-off' [EES] 	139-2272	LED-24/72W / 1050 mA - 2700 K	8823.6	81 W	80	12.60
	139-2278	LED-24/104W / 1400 mA - 2700 K	10967.4	112 W	80	12.60
	139-3137	LED-48/72W / 500 mA - 2700 K	6498.9	77 W	80	12.60
	139-3138	LED-48/72W / 500 mA - 3000 K	6947.1	77 W	80	12.60
	139-3139	LED-48/72W / 500 mA - 4000 K	6947.1	77 W	80	12.60
	139-3141	LED-48/96W / 700 mA - 2700 K	8515.8	105.5 W	80	12.60
	139-3142	LED-48/96W / 700 mA - 3000 K	9188.2	105.5 W	80	12.60
	139-3143	LED-48/96W / 700 mA - 4000 K	9188.2	105.5 W	80	12.60
	139-3145	LED-48/127W / 900 mA - 2700 K	10308.7	139 W	80	12.60
	139-3146	LED-48/127W / 900 mA - 3000 K	10981	139 W	80	12.60
139-3147	LED-48/127W / 900 mA - 4000 K	10981	139 W	80	12.60	
symmetrisch mediumstrahlend [M] 	139-1812	LED-24/48W / 700 mA - 3000 K	6304.7	54 W	80	12.60
	139-1813	LED-24/48W / 700 mA - 4000 K	6739.5	54 W	80	12.60
	139-1818	LED-24/72W / 1050 mA - 3000 K	9348.3	81 W	80	12.60
	139-1819	LED-24/72W / 1050 mA - 4000 K	9783.1	81 W	80	12.60
	139-1824	LED-24/104W / 1400 mA - 3000 K	11497.6	112 W	80	12.60
	139-1825	LED-24/104W / 1400 mA - 4000 K	12020.2	112 W	80	12.60
	139-2152	LED-24/72W / 1050 mA - 2700 K	8913.5	81 W	80	12.60
	139-2228	LED-24/104W / 1400 mA - 2700 K	10870.4	112 W	80	12.60
	139-2252	LED-24/48W / 700 mA - 2700 K	5869.9	54 W	80	12.60
	wallwash 	139-1812+139-1854	LED-24/48W / 700 mA - 3000 K	5235.8	54 W	80
139-1813+139-1854		LED-24/48W / 700 mA - 4000 K	5596.9	54 W	80	12.60
139-1818+139-1854		LED-24/72W / 1050 mA - 3000 K	7763.5	81 W	80	12.60
139-1819+139-1854		LED-24/72W / 1050 mA - 4000 K	8124.5	81 W	80	12.60
139-1824+139-1854		LED-24/104W / 1400 mA - 3000 K	9548.2	112 W	80	12.60
139-1825+139-1854		LED-24/104W / 1400 mA - 4000 K	9982.2	112 W	80	12.60
139-2152+139-1854		LED-24/72W / 1050 mA - 2700 K	7402.4	81 W	80	12.60
139-2228+139-1854		LED-24/104W / 1400 mA - 2700 K	9027.4	112 W	80	12.60
139-2252+139-1854		LED-24/48W / 700 mA - 2700 K	4874.7	54 W	80	12.60

### Montagezubehör

#### Montagesockel EM

Beschreibung	Artikelnummer	D1	D2	H1	M1	Gewicht (kg)
EM1-M16 AL	270-9038	160	130	203	9	2

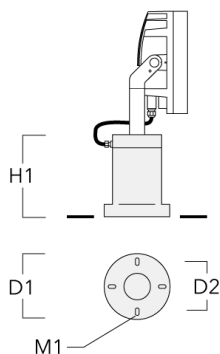

#### Mastaufsatztraverse TA

Beschreibung	Artikelnummer	A	C1	D x L1	Gewicht (kg)	D x S
TA1 Mastaufsatztraverse, einfach* (Ø 76 x 200)	147-0023		130	76 x 200	1.90	76 x 200

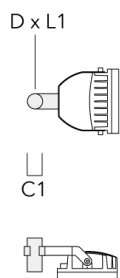

## Scheinwerfer symmetrisch

Beschreibung	Artikelnummer	A	C1	D × L1	Gewicht (kg)	D × S
TA2 Mastaufsatztraverse, zweifach (Ø 76 x 200)	147-0024		130	76 x 200	1.90	76 x 200

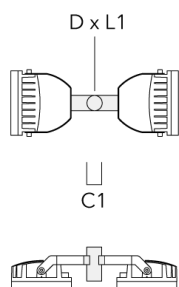

TA2-L Mastaufsatztraverse, zweifach (Ø 76 x 200)	147-0105	±90°	420	76 x 200	16.10	76 x 200
--	----------	------	-----	----------	-------	----------

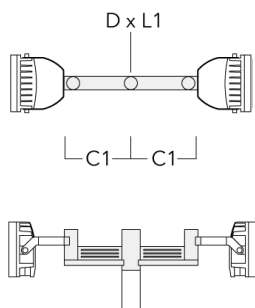

## Scheinwerfer symmetrisch

Beschreibung	Artikelnummer	A	C1	D x L1	Gewicht (kg)	D x S
TA3 Mastaufsatztraverse, dreifach (Ø 89 x 200)	147-0025	±90°	650	89 x 200	17.90	89 x 200

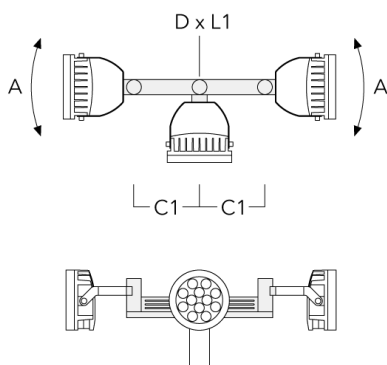

TA4 Mastaufsatztraverse, vierfach (Ø 89 x 200)	147-0099	±90°	650	89 x 200	20.80	89 x 200
--	----------	------	-----	----------	-------	----------

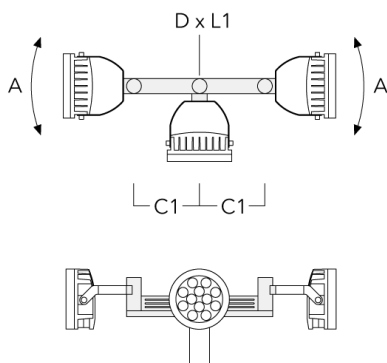



## Scheinwerfer symmetrisch

Beschreibung	Artikelnummer	A	C1	D × L1	Gewicht (kg)	D × S
TA1 Mastaufsatztraverse, einfach (Ø 108 x 200)	147-0096		130	108 x 200	7.50	108 x 200

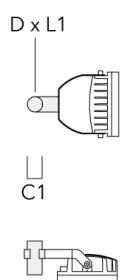

TA2 Mastaufsatztraverse, zweifach (Ø 108 x 200)	147-0097		130	108 x 200	7.50	108 x 200
---	----------	--	-----	-----------	------	-----------

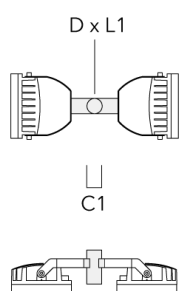

## Scheinwerfer symmetrisch

Beschreibung	Artikelnummer	A	C1	D x L1	Gewicht (kg)	D x S
TA2-L Mastaufsatztraverse, zweifach (Ø 108 x 200)	147-0148	±90°	420	108 x 200	20.20	108 x 200

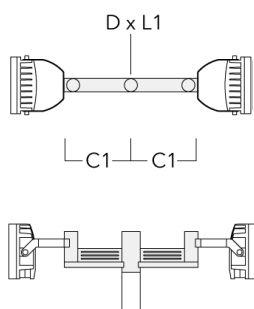

TA3 Mastaufsatztraverse, dreifach (Ø 108 x 200)	147-0098	±90°	650	108 x 200	24.20	108 x 200
---	----------	------	-----	-----------	-------	-----------

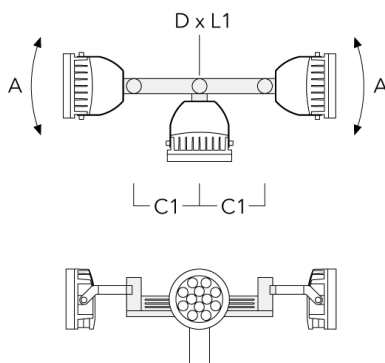

## Scheinwerfer symmetrisch

Beschreibung	Artikelnummer	A	C1	D × L1	Gewicht (kg)	D × S
TA4 Mastaufsatztraverse, vierfach (Ø 108 x 200)	147-0100	±90°	650	108 x 200	24.20	108 x 200

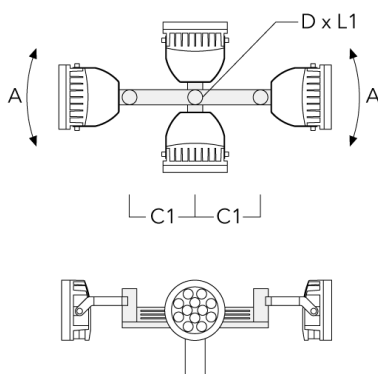

## Mastschelle TS

Beschreibung	Artikelnummer	D1	Gewicht (kg)	D
TS1-2/M12 Mastschelle, einfach (Ø 76-89)	147-0543	76-89	1.40	76-89

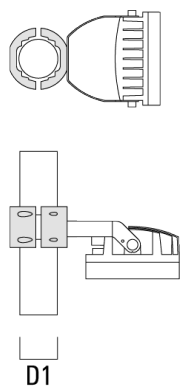

## Scheinwerfer symmetrisch

Beschreibung	Artikelnummer	D1	Gewicht (kg)	D
TS1-2/M12 Mastschelle, einfach (Ø 102-114)	147-0526	102-114	1.50	102-114

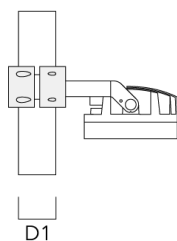
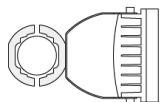

TS1-2/M12 Mastschelle, einfach (Ø 114-133)	147-0544	114-133	1.70	114-133
--	----------	---------	------	---------

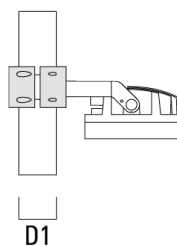
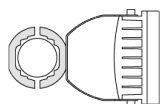

## Scheinwerfer symmetrisch

Beschreibung	Artikelnummer	D1	Gewicht (kg)	D
TS2-2/M12 Mastschelle, zweifach (Ø 76-89)	147-0545	76-89	1.40	76-89

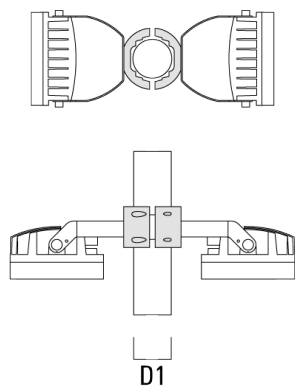

TS2-2/M12 Mastschelle, zweifach (Ø 102-114)	147-0527	102-114	1.50	102-114
---	----------	---------	------	---------

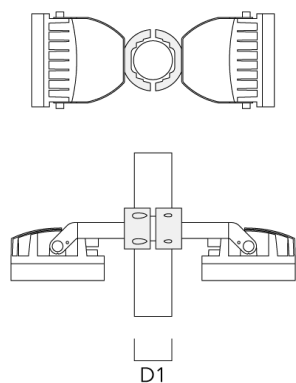

## Scheinwerfer symmetrisch

Beschreibung	Artikelnummer	D1	Gewicht (kg)	D
TS2-2/M12 Mastschelle, zweifach (Ø 114-133)	147-0546	114-133	1.60	114-133

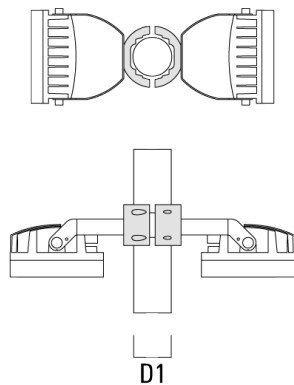

## Erdstück

Beschreibung	Artikelnummer	D1	D2	D3	D4	H1	H2	M1	Gewicht (kg)
Erdstück ESV4	300-0461	145	130	102	108	400	350	8	7.05

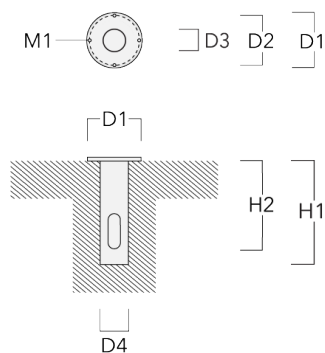

## Scheinwerfer symmetrisch

### Mastschelle PC

Beschreibung	Artikelnummer	D1	Gewicht (kg)
PC2 76-89/60 Mastschelle, zweifach (Ø 76-89)	139-2703	76-89	1.00

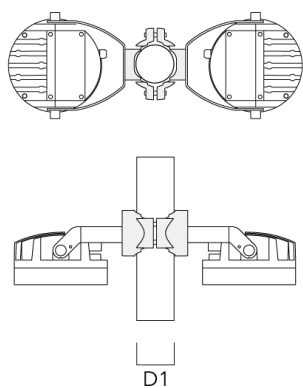

PC1 76-89/60 Mastschelle, einfach (Ø 76-89)	139-2702	76-89	1.00
---	----------	-------	------

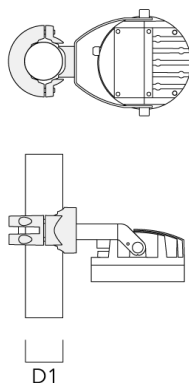

## Scheinwerfer symmetrisch

Beschreibung	Artikelnummer	D1	Gewicht (kg)
PC2 102-114/60 Mast­schelle, zweifach (Ø 102-114)	139-2707	102-114	1.20

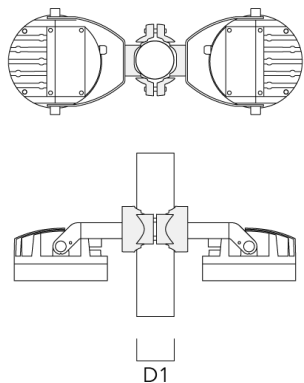

PC1 102-114/60 Mast­schelle, einfach (Ø 102-114)	139-2706	102-114	1.20
--	----------	---------	------

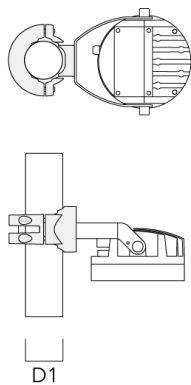



## Scheinwerfer symmetrisch

Beschreibung	Artikelnummer	D1	Gewicht (kg)
PC2 114-133/60 Mastschelle, zweifach (Ø 114-133)	139-2709	114-133	1.40

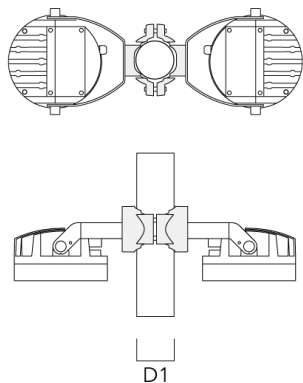

PC1 114-133/60 Mastschelle, einfach (Ø 114-133)	139-2708	114-133	1.40
--	----------	---------	------

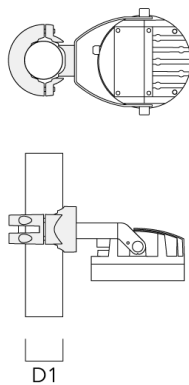

**Scheinwerfer symmetrisch**

---

Beschreibung	Artikelnummer	D1	Gewicht (kg)
PC2 82-109/60 Mastschelle, zweifach (Ø 82-109)	139-2705	82-109	1.10

---

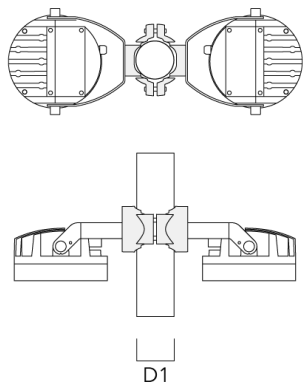

**Steuerung****Eco Step Dim® Basic**

Beschreibung	Artikelnummer
Eco Step Dim® Basic LED	430-0001

**Eco Step Dim® Advanced**

Beschreibung	Artikelnummer
Eco Step Dim® Advanced LED	430-0002

**R2C Ready to Connect**

Beschreibung	Artikelnummer
R2C Ready to Connect (oben)	430-0019

**Optisches Zubehör****Streulinse allseitig**

---

Beschreibung	Artikelnummer	C1
IO-360-FLC240-LED	139-1856	289

---

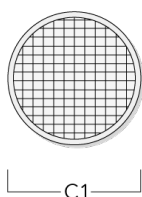

---

**Wabenblende**

---

Beschreibung	Artikelnummer	C1
Wabenblende IW	139-1857	279

---

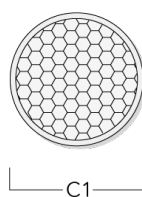

**Abblendtubus**

Beschreibung	Artikelnummer	A	C1
ET-FLC240-LED	139-1859	200	346

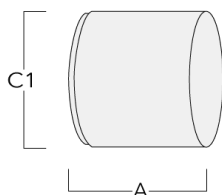
**Seitenblende**

Beschreibung	Artikelnummer	A	C1
ES-FLC240-LED	139-1858	200	346

