





Description

IP66, Class I. Class II on request. IK07. Marine-grade, die-cast aluminium alloy. 5CE superior corrosion protection including PCS hardware. Silicone CCG® Controlled Compression Gasket. Safety glass lens. One cable gland. Second gland for through wiring on request. Integral EC electronic converter, thermally separated. CAD-optimised optics for superior illumination and glare control. OLC® One LED Concept. Factory installed LED circuit board. 1-10V, DALI Interface or Eco Step Dim® on request. Maximum one internal optical accessory possible.

Optional 2200 K version up to max. 1050mA available, except version [EES]. To be specified at time of ordering.

Specifications

Material description

Body	Marine-grade, die-cast aluminium alloy
Lens	Safety glass lens
Colours	<div style="display: flex; flex-direction: column; gap: 5px;"> <div> RAL9004 Signal black</div> <div> RAL9006 White aluminium</div> <div> RAL9007 Grey aluminium</div> <div> RAL7016 Anthracite grey</div> <div> RAL9016 Traffic white</div> </div>
Gasket	Silicone CCG® Controlled Compression Gasket
Fasteners	PCS Polymer Coated Stainless Steel Hardware
Ingress protection	IP66
Impact resistance	IK07
Corrosion resistance	5CE
Windage	0.116 m ²

Electrical description

Power supply	220-240V / 50-60 Hz
Driver / Ballast	Standard. Optional DALI version available. To be specified at time of ordering.
Power factor	> 0.9
Surge protection	6/6 kV (optional SP10)

Additional information

Lifetime	Ta=25° L90B10 > 90000h
Energy efficiency class	C-D (Light source)

Options

Light distribution



symmetric, medium beam [M]



symmetric, narrow beam [E]



symmetric, very narrow beam [EE]



symmetric, wide beam [B]



linear spread, very narrow beam [EE]



wallwash



symmetric, very narrow beam, sharp cut-off [EES]

Colour temperature



3000 K



4000 K



2700 K





Nominal Watt

0 W

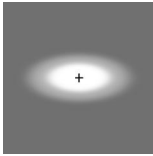

108 W

144 W

Configurations

Light distribution	Part ID	Light source	Rated lumens	Rated input power	CRI	Weight (kg)
linear spread, very narrow beam [EE] 	139-1795+139-1861	LED-36/108W / 1050 mA - 3000 K	13228.8	119 W	80	17.50
	139-1796+139-1861	LED-36/108W / 1050 mA - 4000 K	13844.1	119 W	80	17.50
	139-1801+139-1861	LED-36/155W / 1400 mA - 3000 K	16276	172 W	80	17.50
	139-1802+139-1861	LED-36/155W / 1400 mA - 4000 K	17015.8	172 W	80	17.50
	139-1810+139-1861	LED-36/72W / 700 mA - 3000 K	8921.8	79 W	80	17.50
	139-1811+139-1861	LED-36/72W / 700 mA - 4000 K	9537.1	79 W	80	17.50
	139-2267+139-1861	LED-36/72W / 700 mA - 2700 K	8306.5	79 W	80	17.50
	139-2274+139-1861	LED-36/108W / 1050 mA - 2700 K	12613.5	119 W	80	17.50
	139-2281+139-1861	LED-36/155W / 1400 mA - 2700 K	15388.2	172 W	80	17.50
symmetric, medium beam [M] 	139-1791	LED-36/108W / 1050 mA - 3000 K	14022.4	119 W	80	17.50
	139-1792	LED-36/108W / 1050 mA - 4000 K	14674.6	119 W	80	17.50
	139-1797	LED-36/155W / 1400 mA - 3000 K	17246.3	172 W	80	17.50
	139-1798	LED-36/155W / 1400 mA - 4000 K	18030.3	172 W	80	17.50
	139-1806	LED-36/72W / 700 mA - 3000 K	9457	79 W	80	17.50
	139-1807	LED-36/72W / 700 mA - 4000 K	10109.2	79 W	80	17.50
	139-2175	LED-36/155W / 1400 mA - 2700 K	16305.6	172 W	80	17.50
	139-2255	LED-36/108W / 1050 mA - 2700 K	13370.2	119 W	80	17.50
	139-2258	LED-36/72W / 700 mA - 2700 K	8804.8	79 W	80	17.50
	symmetric, narrow beam [E] 	139-1793	LED-36/108W / 1050 mA - 3000 K	13191.4	119 W	80
139-1794		LED-36/108W / 1050 mA - 4000 K	13805	119 W	80	17.50
139-1799		LED-36/155W / 1400 mA - 3000 K	16236.7	172 W	80	17.50
139-1800		LED-36/155W / 1400 mA - 4000 K	16974.7	172 W	80	17.50
139-1808		LED-36/72W / 700 mA - 3000 K	8896.5	79 W	80	17.50
139-1809		LED-36/72W / 700 mA - 4000 K	9510.1	79 W	80	17.50
139-2231		LED-36/155W / 1400 mA - 2700 K	15351	172 W	80	17.50
139-2256		LED-36/108W / 1050 mA - 2700 K	12577.9	119 W	80	17.50
139-2259		LED-36/72W / 700 mA - 2700 K	8283	79 W	80	17.50
symmetric, very narrow beam [EE] 		139-1795	LED-36/108W / 1050 mA - 3000 K	13881	119 W	80
	139-1796	LED-36/108W / 1050 mA - 4000 K	14526.6	119 W	80	17.50
	139-1801	LED-36/155W / 1400 mA - 3000 K	17400.1	172 W	80	17.50
	139-1802	LED-36/155W / 1400 mA - 4000 K	18191.1	172 W	80	17.50
	139-1810	LED-36/72W / 700 mA - 3000 K	9361.6	79 W	80	17.50
	139-1811	LED-36/72W / 700 mA - 4000 K	10007.2	79 W	80	17.50
	139-2267	LED-36/72W / 700 mA - 2700 K	8715.9	79 W	80	17.50
	139-2274	LED-36/108W / 1050 mA - 2700 K	13235.3	119 W	80	17.50

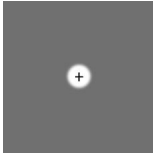
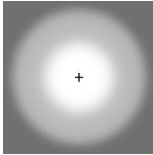
Projectors

Light distribution	Part ID	Light source	Rated lumens	Rated input power	CRI	Weight (kg)
	139-2281	LED-36/155W / 1400 mA - 2700 K	16451	172 W	80	17.50
symmetric, very narrow beam, sharp cut-off [EES] 	139-3149	LED-72/108W / 500 mA - 2700 K	9748.4	119 W	80	17.50
	139-3150	LED-72/108W / 500 mA - 3000 K	10420.7	119 W	80	17.50
	139-3151	LED-72/108W / 500 mA - 4000 K	10420.7	119 W	80	17.50
	139-3153	LED-72/144W / 700 mA - 2700 K			80	17.50
	139-3154	LED-72/144W / 700 mA - 3000 K	13782.2	159 W	80	17.50
	139-3155	LED-72/144W / 700 mA - 4000 K	13782.2	159 W	80	17.50
symmetric, wide beam [B] 	139-1955	LED-36/72W / 700 mA - 3000 K	8972.1	79 W	80	17.50
	139-1956	LED-36/72W / 700 mA - 4000 K	9590.9	79 W	80	17.50
	139-1959	LED-36/108W / 1050 mA - 3000 K	13303.5	119 W	80	17.50
	139-1960	LED-36/108W / 1050 mA - 4000 K	13922.2	119 W	80	17.50
	139-1963	LED-36/155W / 1400 mA - 3000 K	16441.1	172 W	80	17.50
	139-1964	LED-36/155W / 1400 mA - 4000 K	17188.5	172 W	80	17.50
	139-2230	LED-36/155W / 1400 mA - 2700 K	15544.3	172 W	80	17.50
	139-2254	LED-36/108W / 1050 mA - 2700 K	12684.7	119 W	80	17.50
	139-2257	LED-36/72W / 700 mA - 2700 K	8353.3	79 W	80	17.50
	wallwash 	139-1791+139-1860	LED-36/108W / 1050 mA - 3000 K	11645.2	119 W	80
139-1792+139-1860		LED-36/108W / 1050 mA - 4000 K	12186.8	119 W	80	17.50
139-1797+139-1860		LED-36/155W / 1400 mA - 3000 K	14322.3	172 W	80	17.50
139-1798+139-1860		LED-36/155W / 1400 mA - 4000 K	14973.3	172 W	80	17.50
139-1806+139-1860		LED-36/72W / 700 mA - 3000 K	7853.7	79 W	80	17.50
139-1807+139-1860		LED-36/72W / 700 mA - 4000 K	8395.4	79 W	80	17.50
139-2175+139-1860		LED-36/155W / 1400 mA - 2700 K	13541.1	172 W	80	17.50
139-2255+139-1860		LED-36/108W / 1050 mA - 2700 K	11103.5	119 W	80	17.50
139-2258+139-1860		LED-36/72W / 700 mA - 2700 K	7312.1	79 W	80	17.50

Mounting Accessories

Short post EM

Description	Part ID	D1	D2	H1	M1	Weight (kg)
EM1-M16 AL	270-9038	160	130	203	9	2

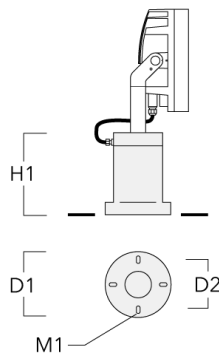

Planted root

Description	Part ID	D1	D2	D3	D4	H1	H2	M1	Weight (kg)
Planted root ESV4	300-0461	145	130	102	108	400	350	8	7.05

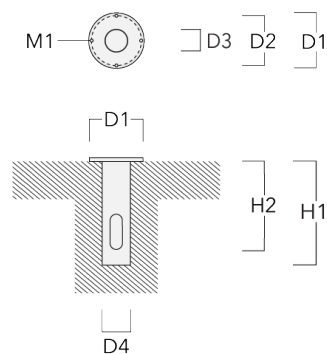

Floodlight mounting bracket TA

Description	Part ID	A	C1	D × L1	Weight (kg)	D × S
TA2 Mounting bracket, double* (Ø 76 x 200)	147-0024		130	76 x 200	1.90	76 x 200

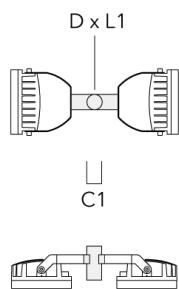

TA1 Mounting bracket, single* (Ø 76 x 200)	147-0023		130	76 x 200	1.90	76 x 200
--	----------	--	-----	----------	------	----------

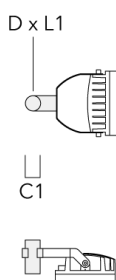

Projectors

Description	Part ID	A	C1	D x L1	Weight (kg)	D x S
TA2-L Mounting bracket, double (Ø 76 x 200)	147-0105	±90°	420	76 x 200	16.10	76 x 200

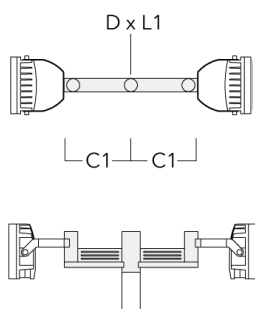

TA3 Mounting bracket, triple (Ø 89 x 200)	147-0025	±90°	650	89 x 200	17.90	89 x 200
---	----------	------	-----	----------	-------	----------

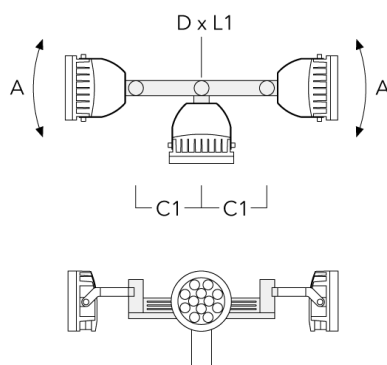

Projectors

Description	Part ID	A	C1	D × L1	Weight (kg)	D × S
TA4 Mounting bracket, quad (Ø 89 x 200)	147-0099	±90°	650	89 x 200	20.80	89 x 200

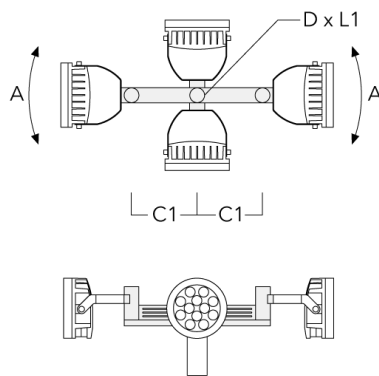

TA1 Mounting bracket, single (Ø 108 x 200)	147-0096		130	108 x 200	7.50	108 x 200
--	----------	--	-----	-----------	------	-----------

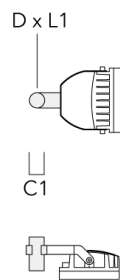

Projectors

Description	Part ID	A	C1	D x L1	Weight (kg)	D x S
TA2 Mounting bracket, double (Ø 108 x 200)	147-0097		130	108 x 200	7.50	108 x 200

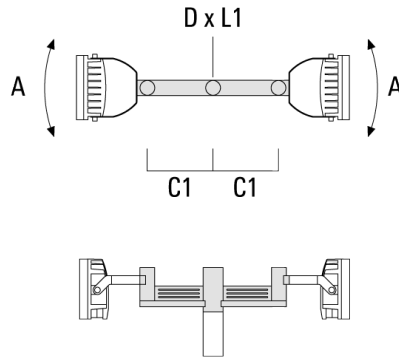

TA3 Mounting bracket, triple (Ø 108 x 200)	147-0098	±90°	650	108 x 200	24.20	108 x 200
--	----------	------	-----	-----------	-------	-----------

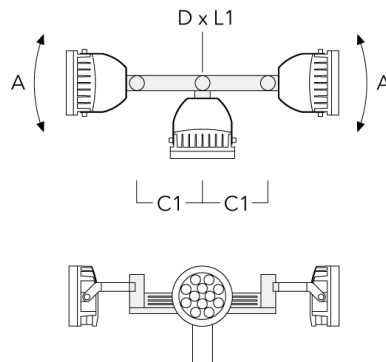

Pole clamp TS

Description	Part ID	D1	Weight (kg)	D
TS1-2/M12 Pole clamp, single (Ø 102-114)	147-0526	102-114	1.50	102-114

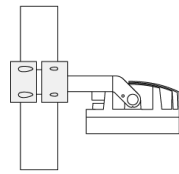
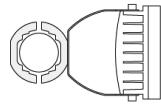

D1

TS1-2/M12 Pole clamp, single (Ø 76-89)	147-0543	76-89	1.40	76-89
--	----------	-------	------	-------

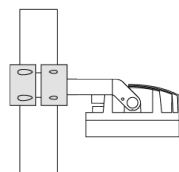
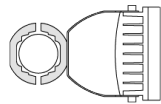

D1

Projectors

Description	Part ID	D1	Weight (kg)	D
TS1-2/M12 Pole clamp, single (Ø 114-133)	147-0544	114-133	1.70	114-133

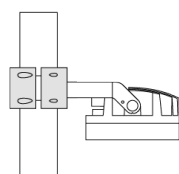
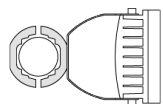

D1

TS2-2/M12 Pole clamp, double (Ø 76-89)	147-0545	76-89	1.40	76-89
--	----------	-------	------	-------

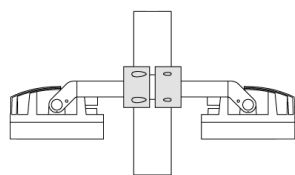
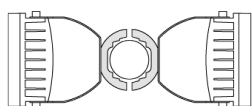

D1

Projectors

Description	Part ID	D1	Weight (kg)	D
TS2-2/M12 Pole clamp, double (Ø 102-114)	147-0527	102-114	1.50	102-114

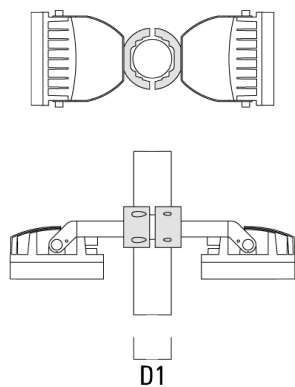

TS2-2/M12 Pole clamp, double (Ø 114-133)	147-0546	114-133	1.60	114-133
--	----------	---------	------	---------

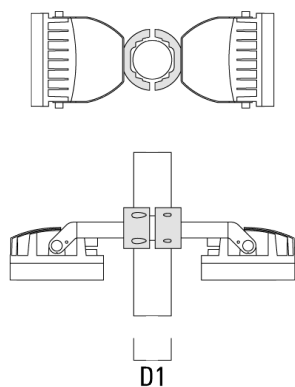

Pole clamp PC

Description	Part ID	D1	Weight (kg)
PC2 76-89/60 Pole clamp, double (Ø 76-89)	139-2703	76-89	1.00

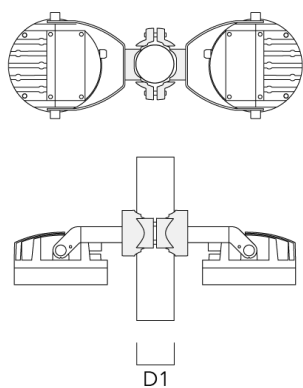

PC1 76-89/60 Pole clamp, single (Ø 76-89)	139-2702	76-89	1.00
---	----------	-------	------

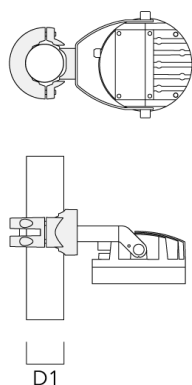

Projectors

Description	Part ID	D1	Weight (kg)
PC2 102-114/60 Pole clamp, double (Ø 102-114)	139-2707	102-114	1.20



PC1 102-114/60 Pole clamp, single (Ø 102-114)	139-2706	102-114	1.20
--	----------	---------	------

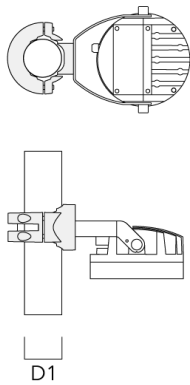

Projectors

Description	Part ID	D1	Weight (kg)
PC2 114-133/60 Pole clamp, double (Ø 114-133)	139-2709	114-133	1.40

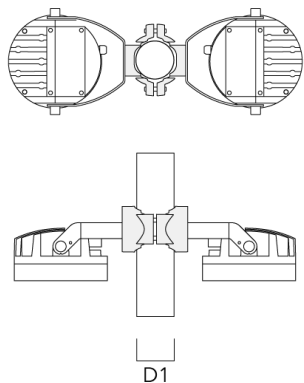

PC1 114-133/60 Pole clamp, single (Ø 114-133)	139-2708	114-133	1.40
--	----------	---------	------

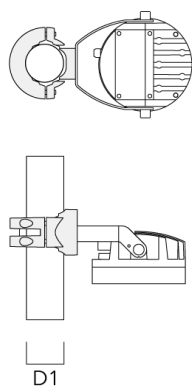

Description	Part ID	D1	Weight (kg)
PC2 82-109/60 Pole camp, double (Ø 82-109)	139-2705	82-109	1.10

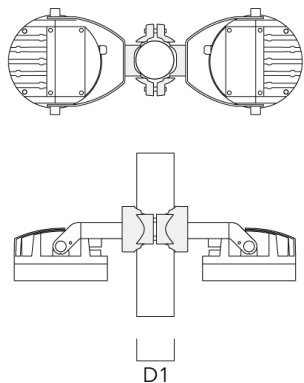

Control**Eco Step Dim® Basic**

Description	Part ID
Eco Step Dim® Basic LED	430-0001

Eco Step Dim® Advanced

Description	Part ID
Eco Step Dim® Advanced LED	430-0002

R2C Ready to Connect

Description	Part ID
R2C Ready to Connect (top)	430-0019

Optical Accessories

Wallwash lens

Description	Part ID	C1
IO-20-FLC260-LED	139-1860	332

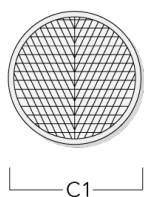

Linear spread lens

Description	Part ID	C1
IO-180-FLC260-LED	139-1861	332

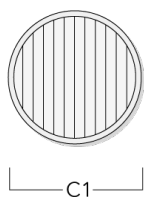

Projectors**Flood lens**

Description	Part ID	C1
IO-360-FLC260-LED	139-1862	332



C1

Honeycomb louvre

Description	Part ID	C1
IW-03-FLC260-LED - [E][EE][EES]	139-1863	324

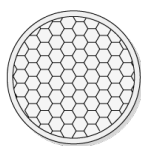

C1

Snoot

Description	Part ID	A	C1
ET-FLC260-LED	139-1865	222	393

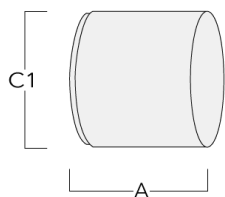

Glare shield

Description	Part ID	A	C1
ES-FLC260-LED	139-1864	222	393

