



**Beschreibung**

IP66, SKI. SKII auf Anfrage. IK07. Korrosionsbeständiger Aluminiumguss. PCS beschichtete Edelstahlschrauben. 5CE Korrosionsschutz. CCG® Controlled Compression Gasket Silikondichtung. Sicherheitsglas. Eine Kabelverschraubung, eine zweite Kabelverschraubung zur Durchverdrahtung auf Anfrage. Eingebaute elektronische Betriebsgeräte, thermisch getrennt. CAD-optimierte OLC® One LED Concept Technik zur Lichtlenkung und Entblendung. Eingebaute LED Platine. 1-10V, DALI Schnittstelle oder Eco Step Dim® auf Anfrage. Maximal ein internes Zubehörteil möglich. Variante mit 2200 K bis max. 1050 mA erhältlich, nicht für [EES] Version. Bei Bestellung bitte angeben.

Spezifikationen**Materialbeschreibung**

Gehäuse	Korrosionsbeständiger Aluminiumguss
Abdeckung	Sicherheitsglasscheibe
Farben	 RAL9004 Signalschwarz  RAL9006 Weißaluminium  RAL9007 Graualuminium  RAL7016 Anthrazitgrau  RAL9016 Verkehrsweiß
Dichtung	CCG® Silikondichtung
Schrauben	PCS beschichtete Edelstahlschrauben
Schutzart	IP66
Schlagfestigkeit	IK07
Korrosionsbeständigkeit	5CE
Windangriffsfläche	0.116 m ²

Elektrische Beschreibung

Netz	220-240V / 50-60 Hz
Netzgerät / Vorschaltgerät	Standard. Variante mit DALI erhältlich, bei Bestellung bitte angeben.
Leistungsfaktor	> 0,9
Überspannungsschutz	6/6 kV (optional SP10)

Weitere Informationen

Lebensdauer	Ta=25° L90B10 > 90000h
Energieeffizienzklasse	C-D (Lichtquelle)

Auswahl

Lichtverteilung



symmetrisch mediumstrahlend [M]



symmetrisch engstrahlend [E]



symmetrisch extrem engstrahlend [EE]



symmetrisch breitstrahlend [B]



bandförmig extrem engstrahlend [EE]



wallwash



symmetrisch extrem engstrahlend, 'sharp cut-off' [EES]

Farbtemperaturen



3000 K

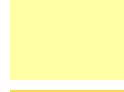

4000 K



2700 K



Nominal Watt

0 W

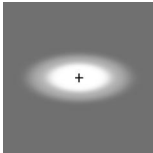
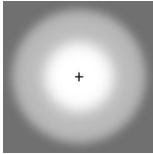

108 W

144 W

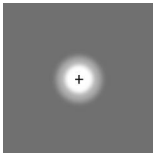
Konfigurationen

Lichtverteilung	Artikelnummer	Lichtquelle	Bemes- sungslicht- strom	Bemes- sungsleis- tung	CRI	Gewicht (kg)
bandförmig extrem engstrahlend [EE] 	139-1795+139-1861	LED-36/108W / 1050 mA - 3000 K	13228.8	119 W	80	17.50
	139-1796+139-1861	LED-36/108W / 1050 mA - 4000 K	13844.1	119 W	80	17.50
	139-1801+139-1861	LED-36/155W / 1400 mA - 3000 K	16276	172 W	80	17.50
	139-1802+139-1861	LED-36/155W / 1400 mA - 4000 K	17015.8	172 W	80	17.50
	139-1810+139-1861	LED-36/72W / 700 mA - 3000 K	8921.8	79 W	80	17.50
	139-1811+139-1861	LED-36/72W / 700 mA - 4000 K	9537.1	79 W	80	17.50
	139-2267+139-1861	LED-36/72W / 700 mA - 2700 K	8306.5	79 W	80	17.50
	139-2274+139-1861	LED-36/108W / 1050 mA - 2700 K	12613.5	119 W	80	17.50
	139-2281+139-1861	LED-36/155W / 1400 mA - 2700 K	15388.2	172 W	80	17.50
symmetrisch breitstrahlend [B] 	139-1955	LED-36/72W / 700 mA - 3000 K	8972.1	79 W	80	17.50
	139-1956	LED-36/72W / 700 mA - 4000 K	9590.9	79 W	80	17.50
	139-1959	LED-36/108W / 1050 mA - 3000 K	13303.5	119 W	80	17.50
	139-1960	LED-36/108W / 1050 mA - 4000 K	13922.2	119 W	80	17.50
	139-1963	LED-36/155W / 1400 mA - 3000 K	16441.1	172 W	80	17.50
	139-1964	LED-36/155W / 1400 mA - 4000 K	17188.5	172 W	80	17.50
	139-2230	LED-36/155W / 1400 mA - 2700 K	15544.3	172 W	80	17.50
	139-2254	LED-36/108W / 1050 mA - 2700 K	12684.7	119 W	80	17.50
	139-2257	LED-36/72W / 700 mA - 2700 K	8353.3	79 W	80	17.50
symmetrisch engstrahlend [E] 	139-1793	LED-36/108W / 1050 mA - 3000 K	13191.4	119 W	80	17.50
	139-1794	LED-36/108W / 1050 mA - 4000 K	13805	119 W	80	17.50
	139-1799	LED-36/155W / 1400 mA - 3000 K	16236.7	172 W	80	17.50
	139-1800	LED-36/155W / 1400 mA - 4000 K	16974.7	172 W	80	17.50
	139-1808	LED-36/72W / 700 mA - 3000 K	8896.5	79 W	80	17.50
	139-1809	LED-36/72W / 700 mA - 4000 K	9510.1	79 W	80	17.50
	139-2231	LED-36/155W / 1400 mA - 2700 K	15351	172 W	80	17.50
	139-2256	LED-36/108W / 1050 mA - 2700 K	12577.9	119 W	80	17.50
	139-2259	LED-36/72W / 700 mA - 2700 K	8283	79 W	80	17.50
symmetrisch extrem engstrahlend [EE] 	139-1795	LED-36/108W / 1050 mA - 3000 K	13881	119 W	80	17.50
	139-1796	LED-36/108W / 1050 mA - 4000 K	14526.6	119 W	80	17.50
	139-1801	LED-36/155W / 1400 mA - 3000 K	17400.1	172 W	80	17.50
	139-1802	LED-36/155W / 1400 mA - 4000 K	18191.1	172 W	80	17.50
	139-1810	LED-36/72W / 700 mA - 3000 K	9361.6	79 W	80	17.50
	139-1811	LED-36/72W / 700 mA - 4000 K	10007.2	79 W	80	17.50
	139-2267	LED-36/72W / 700 mA - 2700 K	8715.9	79 W	80	17.50

Scheinwerfer symmetrisch

Lichtverteilung	Artikelnummer	Lichtquelle	Bemes- sungslicht- strom	Bemes- sungsleis- tung	CRI	Gewicht (kg)	
symmetrisch extrem engstrahlend, 'sharp cut-off' [EES] 	139-2274	LED-36/108W / 1050 mA - 2700 K	13235.3	119 W	80	17.50	
	139-2281	LED-36/155W / 1400 mA - 2700 K	16451	172 W	80	17.50	
	139-3149	LED-72/108W / 500 mA - 2700 K	9748.4	119 W	80	17.50	
	139-3150	LED-72/108W / 500 mA - 3000 K	10420.7	119 W	80	17.50	
	139-3151	LED-72/108W / 500 mA - 4000 K	10420.7	119 W	80	17.50	
	139-3153	LED-72/144W / 700 mA - 2700 K			80	17.50	
	139-3154	LED-72/144W / 700 mA - 3000 K	13782.2	159 W	80	17.50	
	139-3155	LED-72/144W / 700 mA - 4000 K	13782.2	159 W	80	17.50	
	symmetrisch mediumstrahlend [M] 	139-1791	LED-36/108W / 1050 mA - 3000 K	14022.4	119 W	80	17.50
		139-1792	LED-36/108W / 1050 mA - 4000 K	14674.6	119 W	80	17.50
139-1797		LED-36/155W / 1400 mA - 3000 K	17246.3	172 W	80	17.50	
139-1798		LED-36/155W / 1400 mA - 4000 K	18030.3	172 W	80	17.50	
139-1806		LED-36/72W / 700 mA - 3000 K	9457	79 W	80	17.50	
139-1807		LED-36/72W / 700 mA - 4000 K	10109.2	79 W	80	17.50	
139-2175		LED-36/155W / 1400 mA - 2700 K	16305.6	172 W	80	17.50	
139-2255		LED-36/108W / 1050 mA - 2700 K	13370.2	119 W	80	17.50	
139-2258		LED-36/72W / 700 mA - 2700 K	8804.8	79 W	80	17.50	
wallwash 		139-1791+139-1860	LED-36/108W / 1050 mA - 3000 K	11645.2	119 W	80	17.50
	139-1792+139-1860	LED-36/108W / 1050 mA - 4000 K	12186.8	119 W	80	17.50	
	139-1797+139-1860	LED-36/155W / 1400 mA - 3000 K	14322.3	172 W	80	17.50	
	139-1798+139-1860	LED-36/155W / 1400 mA - 4000 K	14973.3	172 W	80	17.50	
	139-1806+139-1860	LED-36/72W / 700 mA - 3000 K	7853.7	79 W	80	17.50	
	139-1807+139-1860	LED-36/72W / 700 mA - 4000 K	8395.4	79 W	80	17.50	
	139-2175+139-1860	LED-36/155W / 1400 mA - 2700 K	13541.1	172 W	80	17.50	
	139-2255+139-1860	LED-36/108W / 1050 mA - 2700 K	11103.5	119 W	80	17.50	
	139-2258+139-1860	LED-36/72W / 700 mA - 2700 K	7312.1	79 W	80	17.50	

Montagezubehör

Montagesockel EM

Beschreibung	Artikelnummer	D1	D2	H1	M1	Gewicht (kg)
EM1-M16 AL	270-9038	160	130	203	9	2

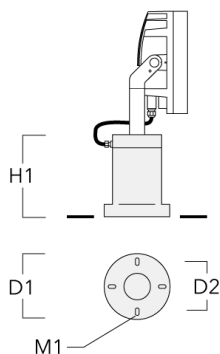

Erdstück

Beschreibung	Artikelnummer	D1	D2	D3	D4	H1	H2	M1	Gewicht (kg)
Erdstück ESV4	300-0461	145	130	102	108	400	350	8	7.05

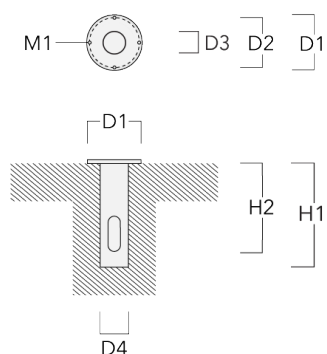

Mastaufsatztraverse TA

WE-EF LEUCHTEN GmbH

Töpinger Straße 16, 29646 Bispingen, Germany - Tel: +49 5194 909-0

info.germany@we-ef.com - <https://we-ef.com/de>

Technische Änderungen und Irrtümer vorbehalten. - Erstellt am 23.10.2024

Scheinwerfer symmetrisch

Beschreibung	Artikelnummer	A	C1	D × L1	Gewicht (kg)	D × S
TA2 Mastaufsatztraverse, zweifach (Ø 76 x 200)	147-0024		130	76 x 200	1.90	76 x 200

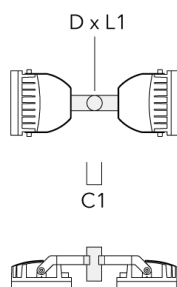

TA1 Mastaufsatztraverse, einfach* (Ø 76 x 200)	147-0023		130	76 x 200	1.90	76 x 200
--	----------	--	-----	----------	------	----------

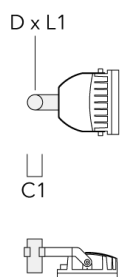

Scheinwerfer symmetrisch

Beschreibung	Artikelnummer	A	C1	D x L1	Gewicht (kg)	D x S
TA2-L Mastaufsatztraverse, zweifach (Ø 76 x 200)	147-0105	±90°	420	76 x 200	16.10	76 x 200

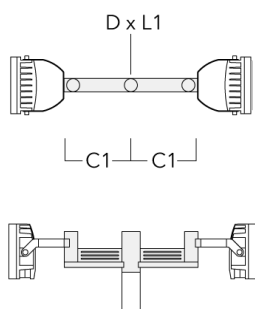

TA3 Mastaufsatztraverse, dreifach (Ø 89 x 200)	147-0025	±90°	650	89 x 200	17.90	89 x 200
--	----------	------	-----	----------	-------	----------

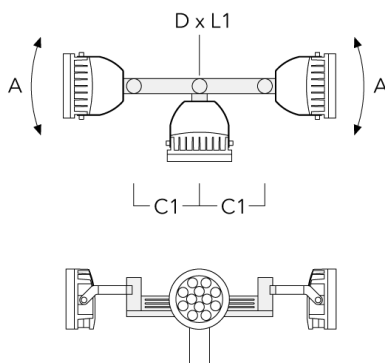

Scheinwerfer symmetrisch

Beschreibung	Artikelnummer	A	C1	D x L1	Gewicht (kg)	D x S
TA4 Mastaufsatztraverse, vierfach (Ø 89 x 200)	147-0099	±90°	650	89 x 200	20.80	89 x 200

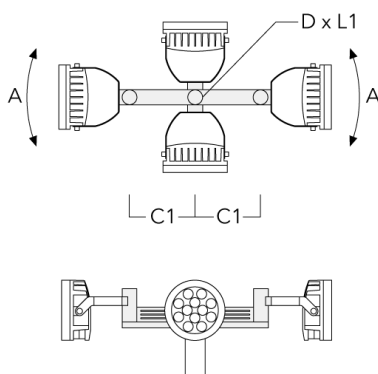

TA1 Mastaufsatztraverse, einfach (Ø 108 x 200)	147-0096		130	108 x 200	7.50	108 x 200
--	----------	--	-----	-----------	------	-----------

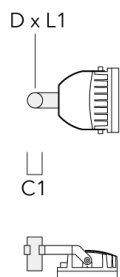

Scheinwerfer symmetrisch

Beschreibung	Artikelnummer	A	C1	D x L1	Gewicht (kg)	D x S
TA2 Mastaufsatztraverse, zweifach (Ø 108 x 200)	147-0097		130	108 x 200	7.50	108 x 200

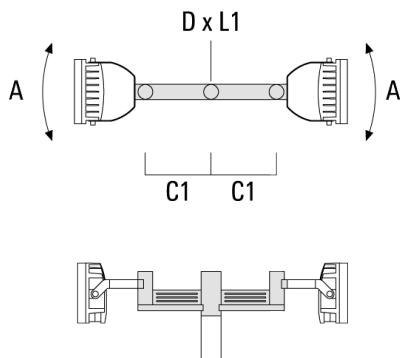

TA3 Mastaufsatztraverse, dreifach (Ø 108 x 200)	147-0098	$\pm 90^\circ$	650	108 x 200	24.20	108 x 200
---	----------	----------------	-----	-----------	-------	-----------

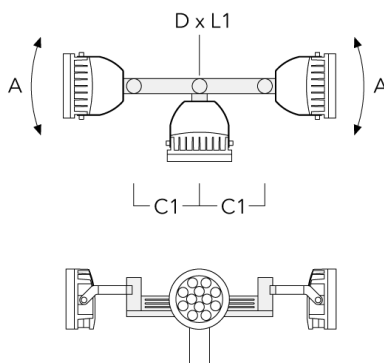

Mastschelle TS

WE-EF LEUCHTEN GmbH

Töpinger Straße 16, 29646 Bispingen, Germany - Tel: +49 5194 909-0

info.germany@we-ef.com - <https://we-ef.com/de>

Technische Änderungen und Irrtümer vorbehalten. - Erstellt am 23.10.2024

Scheinwerfer symmetrisch

Beschreibung	Artikelnummer	D1	Gewicht (kg)	D
TS1-2/M12 Mastschelle, einfach (Ø 102-114)	147-0526	102-114	1.50	102-114

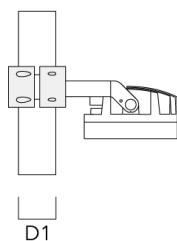
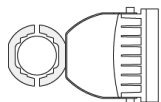

TS1-2/M12 Mastschelle, einfach (Ø 76-89)	147-0543	76-89	1.40	76-89
--	----------	-------	------	-------

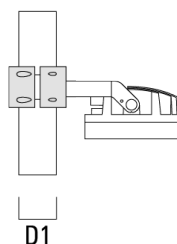
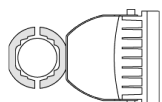

Scheinwerfer symmetrisch

Beschreibung	Artikelnummer	D1	Gewicht (kg)	D
TS1-2/M12 Mastschelle, einfach (Ø 114-133)	147-0544	114-133	1.70	114-133

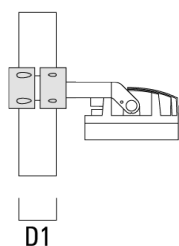
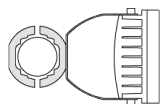

TS2-2/M12 Mastschelle, zweifach (Ø 76-89)	147-0545	76-89	1.40	76-89
---	----------	-------	------	-------

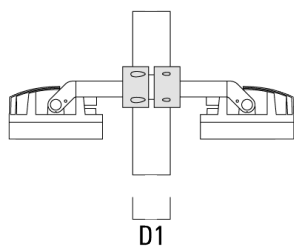
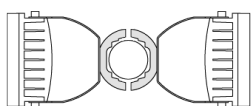

Scheinwerfer symmetrisch

Beschreibung	Artikelnummer	D1	Gewicht (kg)	D
TS2-2/M12 Mastschelle, zweifach (Ø 102-114)	147-0527	102-114	1.50	102-114

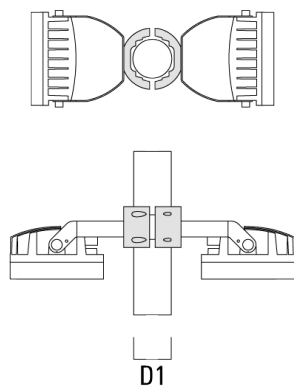

TS2-2/M12 Mastschelle, zweifach (Ø 114-133)	147-0546	114-133	1.60	114-133
---	----------	---------	------	---------

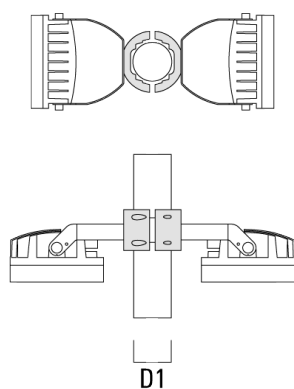

Mastschelle PC

WE-EF LEUCHTEN GmbH

Töpinger Straße 16, 29646 Bispingen, Germany - Tel: +49 5194 909-0

info.germany@we-ef.com - <https://we-ef.com/de>

Technische Änderungen und Irrtümer vorbehalten. - Erstellt am 23.10.2024

Scheinwerfer symmetrisch

Beschreibung	Artikelnummer	D1	Gewicht (kg)
PC2 76-89/60 Mastschelle, zweifach (Ø 76-89)	139-2703	76-89	1.00

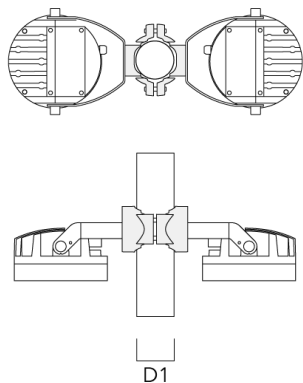

PC1 76-89/60 Mastschelle, einfach (Ø 76-89)	139-2702	76-89	1.00
---	----------	-------	------

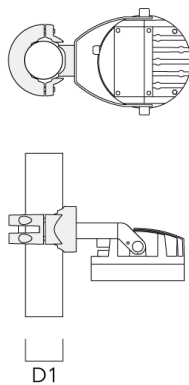

Scheinwerfer symmetrisch

Beschreibung	Artikelnummer	D1	Gewicht (kg)
PC2 102-114/60 Mastschelle, zweifach (Ø 102-114)	139-2707	102-114	1.20

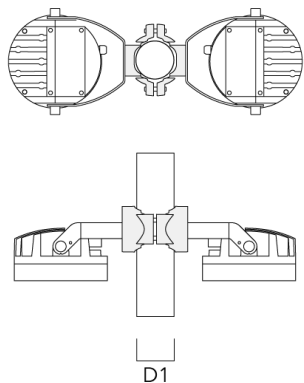

PC1 102-114/60 Mastschelle, einfach (Ø 102-114)	139-2706	102-114	1.20
---	----------	---------	------

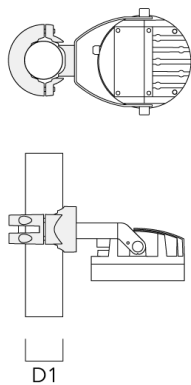

Scheinwerfer symmetrisch

Beschreibung	Artikelnummer	D1	Gewicht (kg)
PC2 114-133/60 Mastschelle, zweifach (Ø 114-133)	139-2709	114-133	1.40

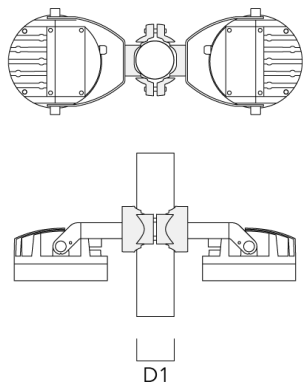

PC1 114-133/60 Mastschelle, einfach (Ø 114-133)	139-2708	114-133	1.40
---	----------	---------	------

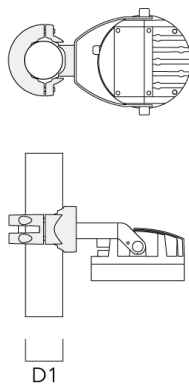

Scheinwerfer symmetrisch

Beschreibung	Artikelnummer	D1	Gewicht (kg)
PC2 82-109/60 Mastschelle, zweifach (Ø 82-109)	139-2705	82-109	1.10

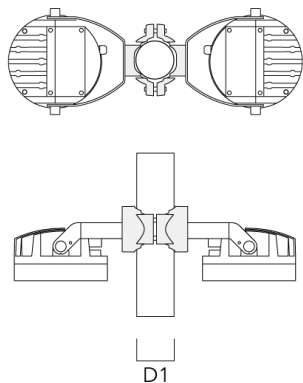

Steuerung**Eco Step Dim® Basic**

Beschreibung	Artikelnummer
Eco Step Dim® Basic LED	430-0001

Eco Step Dim® Advanced

Beschreibung	Artikelnummer
Eco Step Dim® Advanced LED	430-0002

Optisches Zubehör**Wallwash Linse**

Beschreibung	Artikelnummer	C1
IO-20-FLC260-LED	139-1860	332

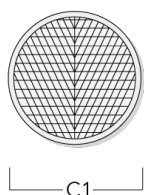
**Streulinse bandförmig**

Beschreibung	Artikelnummer	C1
IO-180-FLC260-LED	139-1861	332

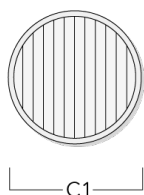
**Streulinse allseitig****WE-EF LEUCHTEN GmbH**

Töpinger Straße 16, 29646 Bispingen, Germany - Tel: +49 5194 909-0

info.germany@we-ef.com - <https://we-ef.com/de>

Technische Änderungen und Irrtümer vorbehalten. - Erstellt am 23.10.2024

Scheinwerfer symmetrisch

Beschreibung	Artikelnummer C1	
IO-360-FLC260-LED	139-1862	332

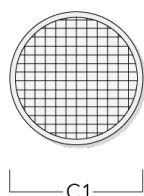

Wabenblende

Beschreibung	Artikelnummer C1	
IW-03-FLC260-LED - [E][EE][EES]	139-1863	324

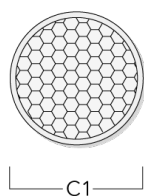

Abblendtubus**WE-EF LEUCHTEN GmbH**

Töpinger Straße 16, 29646 Bispingen, Germany - Tel: +49 5194 909-0

info.germany@we-ef.com - <https://we-ef.com/de>

Technische Änderungen und Irrtümer vorbehalten. - Erstellt am 23.10.2024

Scheinwerfer symmetrisch

Beschreibung	Artikelnummer	A	C1
ET-FLC260-LED	139-1865	222	393

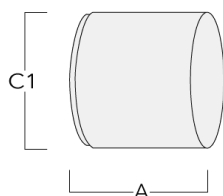

Seitenblende

Beschreibung	Artikelnummer	A	C1
ES-FLC260-LED	139-1864	222	393

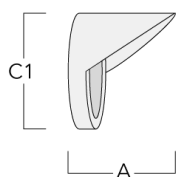

Elektrisches Zubehör

Platine

Beschreibung	Artikelnummer	A	B	C1	Gewicht (kg)
PT110 mit 2 Sicherungen E14 für HI 2000W, ~400V/9,60-11,30A	400-0180[komp]500	145	160	160	13.60

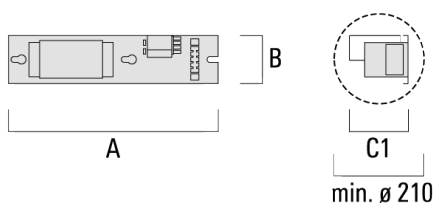

PT110 mit 1 Sicherung E14 für HI 1000W, ~230V/9,30-9,60A	400-0301[komp]500	145	160	160	10.90
---	-------------------	-----	-----	-----	-------

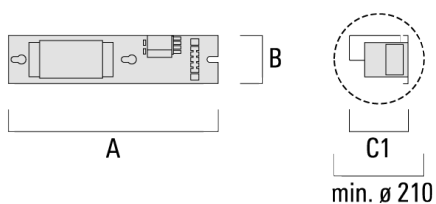

Gusskästen DK6/DK6A (HI 2000W)

WE-EF LEUCHTEN GmbH

Töpinger Straße 16, 29646 Bispingen, Germany - Tel: +49 5194 909-0

info.germany@we-ef.com - <https://we-ef.com/de>

Technische Änderungen und Irrtümer vorbehalten. - Erstellt am 23.10.2024

Scheinwerfer symmetrisch

Beschreibung	Artikelnummer	A	B	C1	M1
DK6A für HI 2000W, ~400V/9,60-11,30 A	400-0271[komp]475	290	220	20	

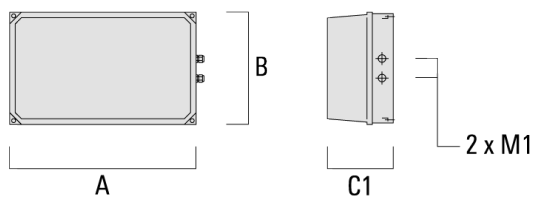

Gusskästen DK5/DK5A

Beschreibung	Artikelnummer	A	B	C1	M1	Gewicht (kg)
DK5A für HI 1000W, ~230V/9,30-9,60 A	400-0121[komp]250	230	220	2	2	13.00

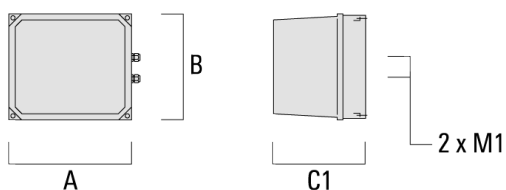

FLC260 LED

Scheinwerfer symmetrisch

WE-EF LEUCHTEN GmbH

Töpinger Straße 16, 29646 Bispingen, Germany
Tel: +49 5194 909-0

info.germany@we-ef.com
<https://we-ef.com/de>

Technische Änderungen und Irrtümer vorbehalten.
Erstellt am 23.10.2024