

### Description

Changement de couleurs RGBW. IP66. Classe I. IK07.  
Corps en fonte d'aluminium. Visserie inox avec traitement  
PCS. Protection contre la corrosion 5CE. Joint silicone  
CCG®. Verre de sécurité. LED contrôlables par système  
DMX.

Technologie sans fil DMX Wireless disponible.

**Projecteurs****Spécifications****Description du matériel**

---

Corps	Corps en fonte d'aluminium
Lentille	Verre de sécurité
Couleurs	Peinture poudre disponible avec 35 couleurs différents
Joint	Joint silicone CCG®
Visserie	PCS Polymer Coated Stainless Steel Hardware
IP	IP66
IK	IK07
Protection contre la corrosion	5CE
Surface exposée au vent	0.116 m <sup>2</sup>

---

**Description électrique**

---

Alimentation électrique	220-240V / 50-60 Hz
Driver	DMX
Power factor	> 0.9

---

**Informations complémentaires**

---

Durée de vie	Ta=25° L90B10 > 90000h
Classe d'efficacité énergétique	G

---

## Projecteurs

### Options

#### Types photométriques



faisceau symétrique, médium [M]



faisceau symétrique, intensif [E]



faisceau symétrique, extensif [B]

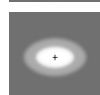

faisceau ovalisante, intensif [E]



wallwash



faisceau symétrique, ultra intensif, 'cut-off' [EES]

#### Température de couleur





RGBW/4K

RGBA

#### Données en sortie de luminaire

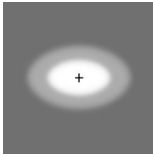
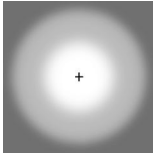
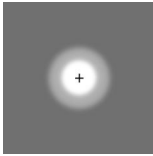
0 W

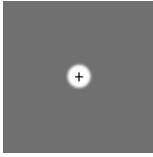
### Configurations

Types photométries	Code produit	Type de Lampes	Rated lumens	Rated input power	IRC	Poids (kg)
faisceau ovalisante, intensif [E] 	139-1891+139-1861	LED-36/144W - RGBW/4K	8595.8	150 W	20/80	18.00
	139-2144+139-1861	LED-36/144W - RGBA	6952.5	150 W	20	18.00
faisceau symétrique, extensif [B] 	139-1965	LED-36/144W - RGBW/4K	8949.1	150 W	20/80	18.00
	139-2143	LED-36/144W - RGBA	7238.3	150 W	20	18.00
faisceau symétrique, intensif [E] 	139-1891	LED-36/144W - RGBW/4K	9431.1	150 W	20/80	18.00
	139-2144	LED-36/144W - RGBA	7628.1	150 W	20	18.00
faisceau symétrique, médium [M] 	139-1889	LED-36/144W - RGBW/4K	9614.9	150 W	20/80	18.00
	139-2145	LED-36/144W - RGBA	7776.7	150 W	20	18.00
faisceau symétrique, ultra intensif, 'cut-off' [EES] 	139-2428	LED-4x18/126W - RGBW/4K	6550.2	141 W	20/80	18.00
	139-2430	LED-4x18/126W - RGBA	5848.4	141 W	20	18.00
wallwash 	139-1889+139-1860	LED-36/144W - RGBW/4K	7797.3	150 W	20/80	18.00
	139-2145+139-1860	LED-36/144W - RGBA	6306.6	150 W	20	18.00

**Accessoires Optiques****Lentille élargissante**

Description	Code produit	C1
I0-360-FLC260-LED	139-1862	332

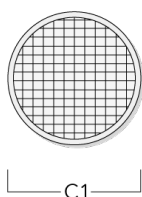
**Grille nid d'abeille**

Description	Code produit	C1	H1
IW-360-FLC260-LED	139-1863	324	

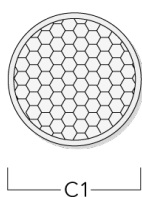
**WE-EF LUMIERE**

ZAC de Chesnes Nord, 6 Rue de Brisson, CS80330, 38290 Satolas et Bonce - Téléphone: +33 4 74 99 14 44  
info.france@we-ef.com - <https://we-ef.com/fr>

Sous réserve de modifications techniques et d'erreurs. - Généré le 10/03/2025

**Projecteurs**

---

Description	Code produit	C1	H1
IW-FLC26_EES-CC LED	139-2434	232	209

---

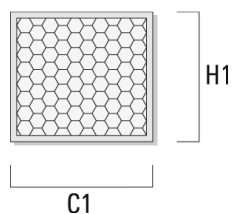

---

**Lentille ovalisante**

---

Description	Code produit	C1
IO-180-FLC260-CC LED	139-1861	332

---

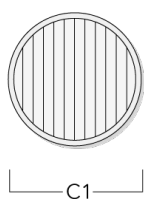

**Projecteurs****Lentille rasante**

Description	Code produit	C1
IO-20-FLC260-CC LED	139-1860	332

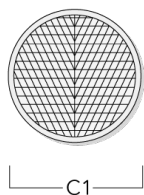
**Canon anti-éblouissement**

Description	Code produit	A	C1
ET-FLC260-LED	139-1865	222	393

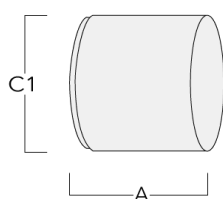
**WE-EF LUMIERE**

ZAC de Chesnes Nord, 6 Rue de Brisson, CS80330, 38290 Satolas et Bonce - Téléphone: +33 4 74 99 14 44  
info.france@we-ef.com - <https://we-ef.com/fr>

Sous réserve de modifications techniques et d'erreurs. - Généré le 10/03/2025



**Projecteurs****Visière**

---

Description	Code produit	A	C1
ES-FLC260-LED	139-1864	222	393

---

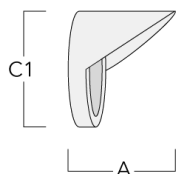

### Accessoires d'installation

#### Collier pour mâts TS

Description	Code produit	D1	Poids (kg)	D
TS1-2/M12 collier simple pour tube (Ø 76-89)	147-0543	76-89	1.40	76-89

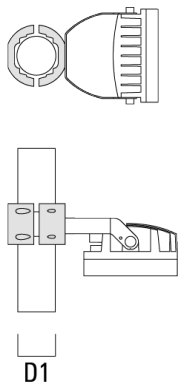

TS1-2/M12 collier simple pour tube (Ø 114-133)	147-0544	114-133	1.70	114-133
--	----------	---------	------	---------

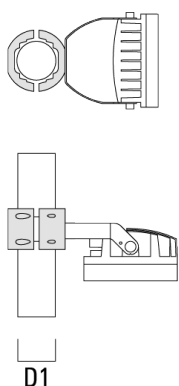

## Projecteurs

Description	Code produit	D1	Poids (kg)	D
TS2-2/M12 collier double pour tube (Ø 76-89)	147-0545	76-89	1.40	76-89

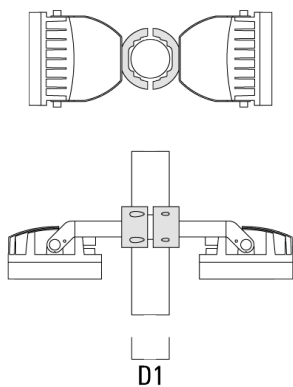

TS2-2/M12 collier double pour tube (Ø 114-133)	147-0546	114-133	1.60	114-133
---	----------	---------	------	---------

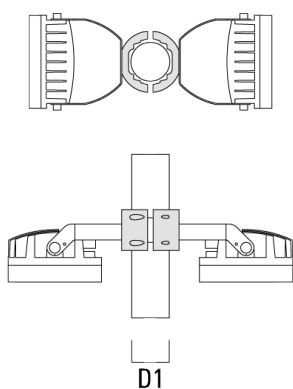

### WE-EF LUMIERE

ZAC de Chesnes Nord, 6 Rue de Brisson, CS80330, 38290 Satolas et Bonce - Téléphone: +33 4 74 99 14 44  
 info.france@we-ef.com - <https://we-ef.com/fr>

Sous réserve de modifications techniques et d'erreurs. - Généré le 10/03/2025

**Traverse pour mâts**

Description	Code produit	C1	D x L1	Poids (kg)	D x S
TA1 traverse simple (Ø 76 x 200)	147-0023	130	76 x 200	1.90	76 x 200

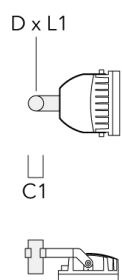

**Collier pour mâts PC**

Description	Code produit	D1	Poids (kg)
PC2 76-89/60 collier double pour tube (Ø 76-89)	139-2703	76-89	1.00

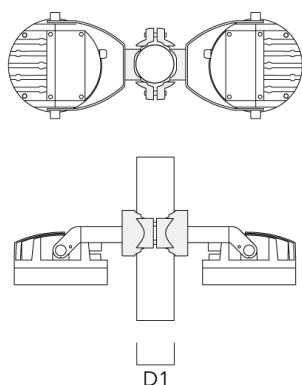

## Projecteurs

Description	Code produit	D1	Poids (kg)
PC1 76-89/60 collier simple (Ø 76-89)	139-2702	76-89	1.00



PC2 102-114/60 collier double pour tube (Ø 102-114)	139-2707	102-114	1.20
---	----------	---------	------

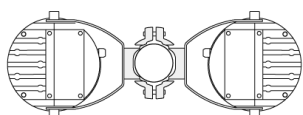

### WE-EF LUMIERE

ZAC de Chesnes Nord, 6 Rue de Brisson, CS80330, 38290 Satolas et Bonce - Téléphone: +33 4 74 99 14 44  
 info.france@we-ef.com - <https://we-ef.com/fr>

Sous réserve de modifications techniques et d'erreurs. - Généré le 10/03/2025

## Projecteurs

Description	Code produit	D1	Poids (kg)
PC1 102-114/60 collier simple (Ø 102-114)	139-2706	102-114	1.20



PC2 114-133/60 collier double pour tube (Ø 114-133)	139-2709	114-133	1.40
---	----------	---------	------

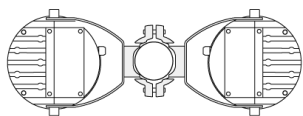

### WE-EF LUMIERE

ZAC de Chesnes Nord, 6 Rue de Brisson, CS80330, 38290 Satolas et Bonce - Téléphone: +33 4 74 99 14 44  
 info.france@we-ef.com - <https://we-ef.com/fr>

Sous réserve de modifications techniques et d'erreurs. - Généré le 10/03/2025

## Projecteurs

Description	Code produit	D1	Poids (kg)
PC1 114-133/60 collier simple (Ø 114-133)	139-2708	114-133	1.40



PC2 82-109/60 collier double pour tube (Ø 82-109)	139-2705	82-109	1.10
---	----------	--------	------

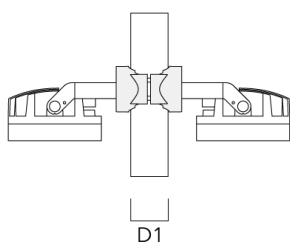
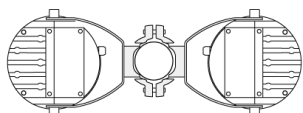

### WE-EF LUMIERE

ZAC de Chesnes Nord, 6 Rue de Brisson, CS80330, 38290 Satolas et Bonce - Téléphone: +33 4 74 99 14 44  
 info.france@we-ef.com - <https://we-ef.com/fr>

Sous réserve de modifications techniques et d'erreurs. - Généré le 10/03/2025

**Projecteurs**

Description	Code produit	D1	Poids (kg)
PC1 82-109/60 collier simple (Ø 82-109)	139-2704	82-109	1.10





**Projecteurs****Control****DMX Controller**

Description	Code produit
DMX Controller	400-0469

**DMX Controller (smart)**

Description	Code produit	Informations complémentaires
DMX Controller (smart)	400-0470	IP20. The Touch Panel is an intuitive and easy-to use keypad or one DMX universe. It can store up to 36 scenes; alternatively, via ....



### DMX Controller - RDM ready

Description	Code produit
DMX Controller - RDM ready	400-0471



### DMX Splitter

Description	Code produit
DMX Splitter	400-0473



#### WE-EF LUMIERE

ZAC de Chesnes Nord, 6 Rue de Brisson, CS80330, 38290 Satolas et Bonce - Téléphone: +33 4 74 99 14 44  
 info.france@we-ef.com - <https://we-ef.com/fr>

Sous réserve de modifications techniques et d'erreurs. - Généré le 10/03/2025

**DMX Booster Box**

---

Description	Code produit
DMX Booster Box	400-0474

---

**DMX Motion Sensor**

---

Description	Code produit
DMX Motion Sensor	400-0478

---



**DMX Termination Plug**

Description	Code produit
DMX Termination Plug	400-0475

**DMX Plug and Socket**

Description	Code produit
DMX Plug and Socket	400-0479



**DMX Combination Cable**

---

Description	Code produit
DMX Combination Cable	400-0480

---



---

**DMX Wireless Repeater**

---

Description	Code produit
DMX Wireless Repeater	400-0477

---



**DMX Wireless Transceiver**

---

Description	Code produit
DMX Wireless Transceiver	400-0476

---

**DMX Controller (smart) - RDM ready**

---

Description	Code produit
DMX Controller (smart) - RDM ready	400-0472

---

