





Beschreibung

RGBW/RGBA Farbwechsler. IP66, SKI. SKII auf Anfrage. IK07. Korrosionsbeständiger Aluminiumguss. PCS beschichtete Edelstahlschrauben. 5CE Korrosionsschutz. CCG® Controlled Compression Gasket Silikondichtung. Sicherheitsglas. Eine Kabelverschraubung, eine zweite Kabelverschraubung zur Durchverdrahtung als Variante erhältlich. Eingebaute elektronische Betriebsgeräte, thermisch getrennt. CAD-optimierte OLC® One LED Concept Technik zur Lichtlenkung und Entblendung. Eingebaute LED Platine. DMX Schnittstelle. M20 Kabelverschraubung für Netz- und DMX-Kabel vorgesehen, WE-EF empfiehlt ein Kombikabel für DMX & Power "Power PUR-SR 3x1,5 + DMX".

Spezifikationen**Materialbeschreibung**

Gehäuse	Korrosionsbeständiger Aluminiumguss
Abdeckung	Sicherheitsglasscheibe
Farben	 RAL9004 Signalschwarz  RAL9006 Weißaluminium  RAL9007 Graualuminium  RAL7016 Anthrazitgrau  RAL9016 Verkehrsweiß
Dichtung	CCG® Silikondichtung
Schrauben	PCS beschichtete Edelstahlschrauben
Schutzart	IP66
Schlagfestigkeit	IK07
Korrosionsbeständigkeit	5CE
Windangriffsfläche	0.054 m ²

Elektrische Beschreibung

Netz	220-240V / 50-60 Hz
Netzgerät / Vorschaltgerät	DMX
Leistungsfaktor	> 0.9
Überspannungsschutz	1/2 kV (optional SP10)

Weitere Informationen

Lebensdauer	Ta=25° L90B10 > 90000h
Energieeffizienzklasse	G (Lichtquelle)

Auswahl

Lichtverteilung



symmetrisch breitstrahlend [B]



symmetrisch mediumstrahlend [M]



symmetrisch extrem engstrahlend, 'sharp cut-off' [EES]



bandförmig engstrahlend [E]



wallwash



symmetrisch engstrahlend [E]



bandförmig extrem engstrahlend, 'sharp cut-off' [EES]

Farbtemperaturen





RGBW/4K

RGBA

Nominal Watt

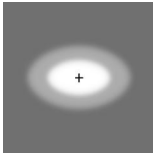
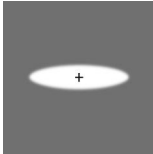
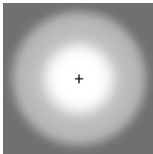
0 W

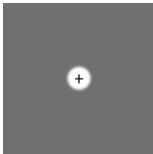
Konfigurationen

Lichtverteilung	Artikelnummer	Lichtquelle	Bemes- sungslicht- strom	Bemes- sungsleis- tung	CRI	Gewicht (kg)
bandförmig engstrahlend [E] 	139-1914+139-1849	LED-12/48W - RGBW/4K	2865.3	50 W	20/80	7.70
	139-2138+139-1849	LED-12/48W - RGBA	2317.5	50 W	20	7.70
bandförmig extrem engstrahlend, 'sharp cut-off' [EES] 	139-2420+139-1849	LED-4x6/42W - RGBW/4K	2121.5	49 W	20/80	7.70
	139-2422+139-1849	LED-4x6/42W - RGBA	1894.2	49 W	20	7.70
symmetrisch breitstrahlend [B] 	139-1929	LED-12/48W - RGBW/4K	2983	50 W	20/80	7.70
	139-2137	LED-12/48W - RGBA	2412.8	50 W	20	7.70
symmetrisch engstrahlend [E] 	139-1914	LED-12/48W - RGBW/4K	3143.7	50 W	20/80	7.70
	139-2138	LED-12/48W - RGBA	2542.7	50 W	20	7.70
symmetrisch extrem engstrahlend, 'sharp cut-off' [EES] 	139-2420	LED-4x6/42W - RGBW/4K	2183.4	49 W	20/80	7.70
	139-2422	LED-4x6/42W - RGBA	1949.5	49 W	20	7.70
symmetrisch mediumstrahlend [M] 	139-1913	LED-12/48W - RGBW/4K	3205	50 W	20/80	7.70
	139-2139	LED-12/48W - RGBA	2592.2	50 W	20	7.70
wallwash 	139-1913+139-1848	LED-12/48W - RGBW/4K	2599.1	50 W	20/80	7.70
	139-2139+139-1848	LED-12/48W - RGBA	2102.2	50 W	20	7.70

Steuerung**Eco Step Dim® Basic**

Beschreibung	Artikelnummer
Eco Step Dim® Basic LED	430-0001

Eco Step Dim® Advanced

Beschreibung	Artikelnummer
Eco Step Dim® Advanced LED	430-0002

DMX Controller

Beschreibung	Artikelnummer
DMX Controller	400-0469

DMX Controller (smart)

Beschreibung	Artikelnummer	Weitere Informationen
DMX Controller (smart)	400-0470	IP20. The Touch Panel is an intuitive and easy-to use keypad or one DMX universe. It can store up to 36 scenes; alternatively, via



Scheinwerfer symmetrisch

DMX Controller - RDM ready

Beschreibung	Artikelnummer
DMX Controller - RDM ready	400-0471



DMX Splitter

Beschreibung	Artikelnummer
DMX Splitter	400-0473



Scheinwerfer symmetrisch

DMX Booster Box

Beschreibung	Artikelnummer
DMX Booster Box	400-0474



DMX Motion Sensor

Beschreibung	Artikelnummer
DMX Motion Sensor	400-0478



DMX Termination Plug

Beschreibung	Artikelnummer
DMX Termination Plug	400-0475



DMX Plug and Socket

Beschreibung	Artikelnummer
DMX Plug and Socket	400-0479



DMX Combination Cable

Beschreibung	Artikelnummer
DMX Combination Cable	400-0480



DMX Wireless Repeater

Beschreibung	Artikelnummer
DMX Wireless Repeater	400-0477



Scheinwerfer symmetrisch**DMX Wireless Transceiver**

Beschreibung	Artikelnummer
DMX Wireless Transceiver	400-0476

**DMX Controller (smart) - RDM ready**

Beschreibung	Artikelnummer
DMX Controller (smart) - RDM ready	400-0472

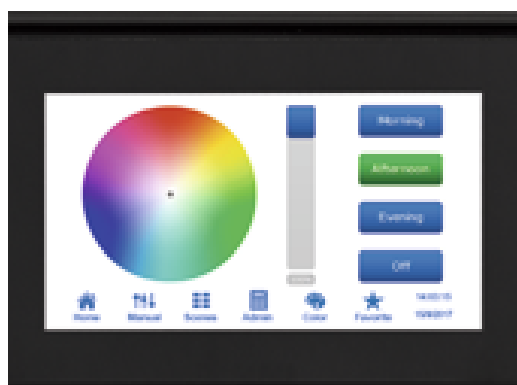
**R2C Ready to Connect**

Beschreibung	Artikelnummer
R2C Ready to Connect (oben)	430-0019

WE-EF LEUCHTEN GmbH

Töpinger Straße 16, 29646 Bispingen, Germany - Tel: +49 5194 909-0

info.germany@we-ef.com - <https://we-ef.com/de>

Technische Änderungen und Irrtümer vorbehalten. - Erstellt am 10.03.2025

DMX Wireless Antenna

Beschreibung	Artikelnummer
Antenne RF 5dB	430-0036
Antenne RF1.8 dB	430-0018

Montagezubehör

Mastaufsatztraverse TA

Beschreibung	Artikelnummer	A	C1	D × L1	Gewicht (kg)	D × S
TA1 Mastaufsatztraverse, einfach (Ø 108 x 200)	147-0096		130	108 x 200	7.50	108 x 200

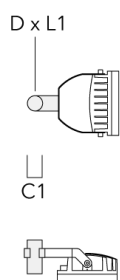

TA2 Mastaufsatztraverse, zweifach (Ø 108 x 200)	147-0097		130	108 x 200	7.50	108 x 200
---	----------	--	-----	-----------	------	-----------

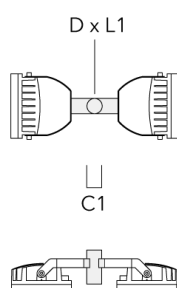

Scheinwerfer symmetrisch

Beschreibung	Artikelnummer	A	C1	D x L1	Gewicht (kg)	D x S
TA2-L Mastaufsatztraverse, zweifach (Ø 108 x 200)	147-0148	±90°	420	108 x 200	20.20	108 x 200

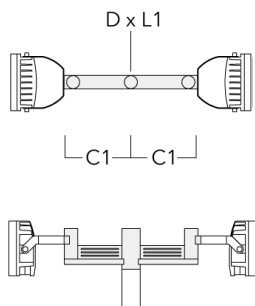

TA2-L Mastaufsatztraverse, zweifach (Ø 76 x 200)	147-0105	±90°	420	76 x 200	16.10	76 x 200
---	----------	------	-----	----------	-------	----------

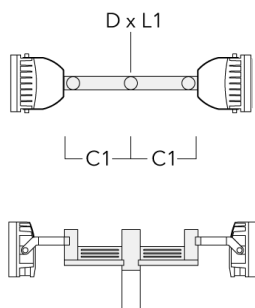

Scheinwerfer symmetrisch

Beschreibung	Artikelnummer	A	C1	D x L1	Gewicht (kg)	D x S
TA3 Mastaufsatztraverse, dreifach (Ø 89 x 200)	147-0025	±90°	650	89 x 200	17.90	89 x 200

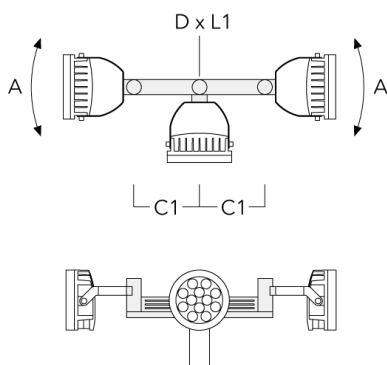

TA3 Mastaufsatztraverse, dreifach (Ø 108 x 200)	147-0098	±90°	650	108 x 200	24.20	108 x 200
---	----------	------	-----	-----------	-------	-----------

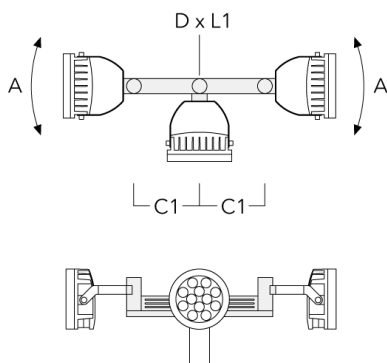

Scheinwerfer symmetrisch

Beschreibung	Artikelnummer	A	C1	D x L1	Gewicht (kg)	D x S
TA4 Mastaufsatztraverse, vierfach (Ø 89 x 200)	147-0099	±90°	650	89 x 200	20.80	89 x 200

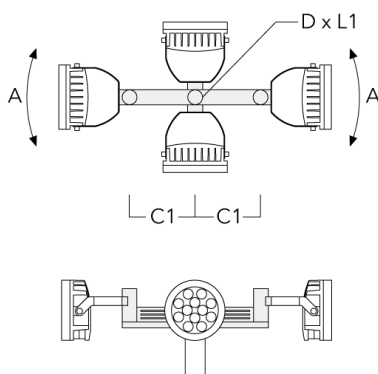

TA4 Mastaufsatztraverse, vierfach (Ø 108 x 200)	147-0100	±90°	650	108 x 200	24.20	108 x 200
---	----------	------	-----	-----------	-------	-----------

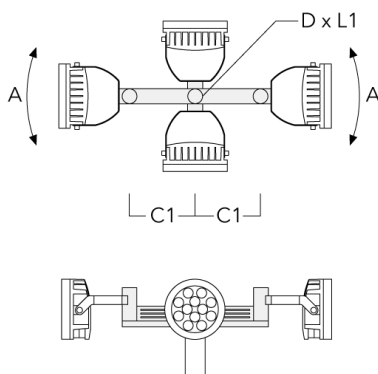

Scheinwerfer symmetrisch

Beschreibung	Artikelnummer	A	C1	D × L1	Gewicht (kg)	D × S
TA2 Mastaufsatztraverse, zweifach (Ø 76 x 200)	147-0024		130	76 x 200	1.90	76 x 200

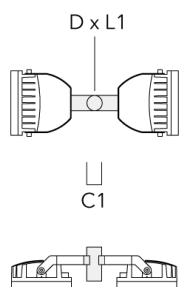

TA1 Mastaufsatztraverse, einfach* (Ø 76 x 200)	147-0023		130	76 x 200	1.50	76 x 200
--	----------	--	-----	----------	------	----------

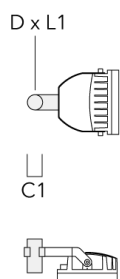

Mastschelle TS

Beschreibung	Artikelnummer	D1	Gewicht (kg)	D
TS1-2/M12 Mastschelle, einfach (Ø 102-114)	147-0526	102-114	1.50	102-114

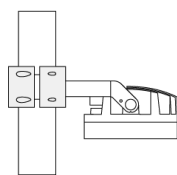
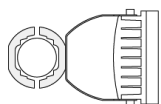

D1

TS1-2/M12 Mastschelle, einfach (Ø 114-133)	147-0544	114-133	1.70	114-133
--	----------	---------	------	---------

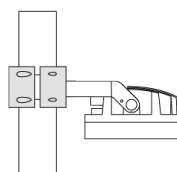
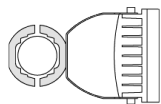

D1

Scheinwerfer symmetrisch

Beschreibung	Artikelnummer	D1	Gewicht (kg)	D
TS1-2/M12 Mastschelle, einfach (Ø 76-89)	147-0543	76-89	1.40	76-89

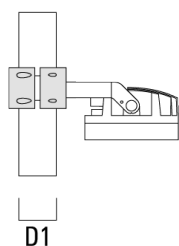
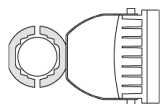

TS2-2/M12 Mastschelle, zweifach (Ø 76-89)	147-0545	76-89	1.40	76-89
---	----------	-------	------	-------

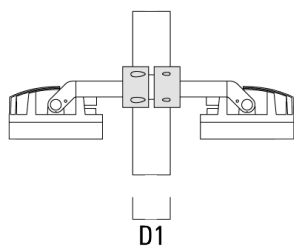
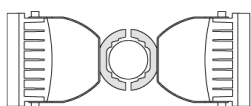

Scheinwerfer symmetrisch

Beschreibung	Artikelnummer	D1	Gewicht (kg)	D
TS2-2/M12 Mastschelle, zweifach (Ø 114-133)	147-0546	114-133	1.60	114-133

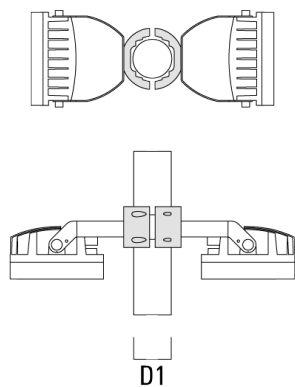

TS2-2/M12 Mastschelle, zweifach (Ø 102-114)	147-0527	102-114	1.50	102-114
---	----------	---------	------	---------

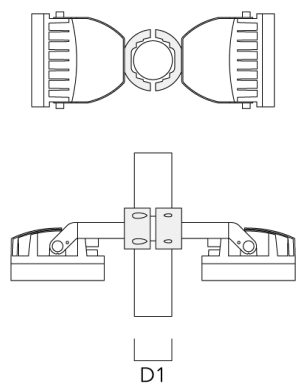

Scheinwerfer symmetrisch

Erdstück

Beschreibung	Artikelnummer	D1	D2	D3	D4	H1	H2	M1	Gewicht (kg)
Erdstück ESV4	300-0461	145	130	102	108	400	350	8	7.05

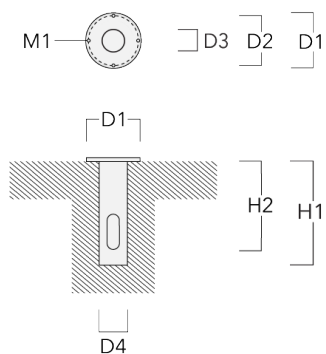

Mastschelle PC

Beschreibung	Artikelnummer	D1	Gewicht (kg)
PC2 76-89/60 Mastschelle, zweifach (Ø 76-89)	139-2703	76-89	1.00

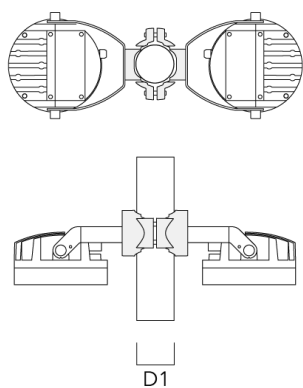

Scheinwerfer symmetrisch

Beschreibung	Artikelnummer	D1	Gewicht (kg)
PC1 76-89/60 Mastschelle, einfach (Ø 76-89)	139-2702	76-89	1.00

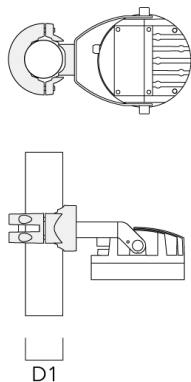

PC2 102-114/60 Mastschelle, zweifach (Ø 102-114)	139-2707	102-114	1.20
--	----------	---------	------

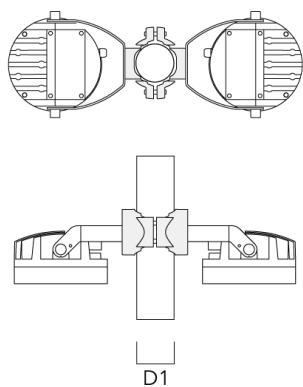

Scheinwerfer symmetrisch

Beschreibung	Artikelnummer	D1	Gewicht (kg)
PC1 102-114/60 Mastschelle, einfach (Ø 102-114)	139-2706	102-114	1.20

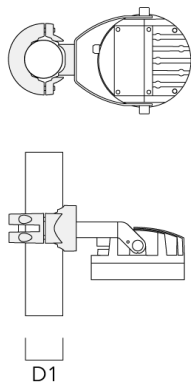

PC2 114-133/60 Mastschelle, zweifach (Ø 114-133)	139-2709	114-133	1.40
---	----------	---------	------

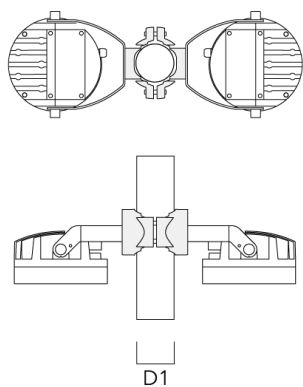

Scheinwerfer symmetrisch

Beschreibung	Artikelnummer	D1	Gewicht (kg)
PC1 114-133/60 Mastschelle, einfach (Ø 114-133)	139-2708	114-133	1.40

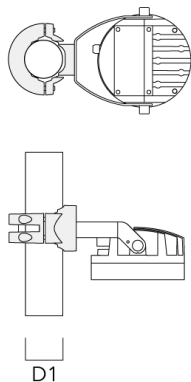

PC2 82-109/60 Mastschelle, zweifach (Ø 82-109)	139-2705	82-109	1.10
---	----------	--------	------

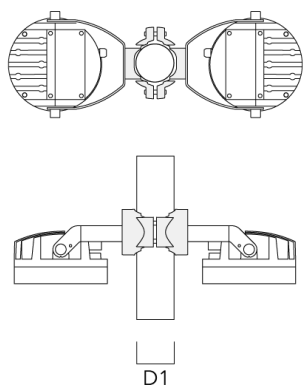

Scheinwerfer symmetrisch

Beschreibung	Artikelnummer	D1	Gewicht (kg)
PC1 82-109/60 Mastschelle, einfach (Ø 82-109)	139-2704	82-109	1.10

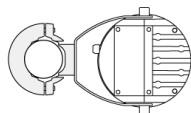

Optisches Zubehör**Seitenblende**

Beschreibung	Artikelnummer	A	C1
Seitenblende ES	139-1852	159	266

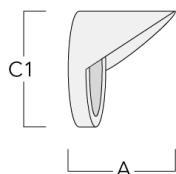
**Abblendtubus**

Beschreibung	Artikelnummer	A	C1
Abblendtubus ET	139-1853	160	266

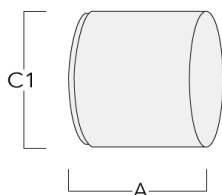

Scheinwerfer symmetrisch**Streulinse bandförmig**

Beschreibung	Artikelnummer	C1
IO-180-FLC230-LED	139-1849	199

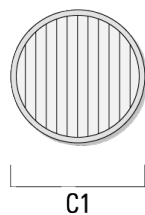

Streulinse allseitig

Beschreibung	Artikelnummer	C1
IO-360-FLC230-LED	139-1850	199

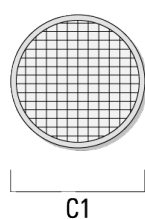

FLC230-CC LED

Scheinwerfer symmetrisch

we-ef

Wallwash Linse

Beschreibung	Artikelnummer	C1
IO-20-FLC230-LED	139-1848	199

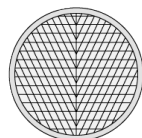

C1

WE-EF LEUCHTEN GmbH

Töpinger Straße 16, 29646 Bispingen, Germany - Tel: +49 5194 909-0
info.germany@we-ef.com - <https://we-ef.com/de>

Technische Änderungen und Irrtümer vorbehalten. - Erstellt am 10.03.2025