

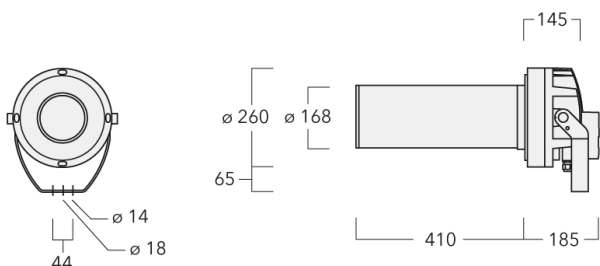







Description

IP66, Class I. Class II on request. IK07. Marine-grade, die-cast aluminium alloy. 5CE superior corrosion protection including PCS hardware. Silicone CCG® Controlled Compression Gasket. Safety glass lens. One cable gland. Second gland for through wiring on request. PMMA LED lens array. Factory installed LED circuit board. LED board can be removed for upgrading. Integral EC electronic converter, thermally separated.

Optional 2200 K version up to max. 1050mA available. To be specified at time of ordering.



Projectors**Specifications****Material description**

Body	Marine-grade, die-cast aluminium alloy
Lens	Safety glass lens
Colours	 RAL9004 Signal black  RAL9006 White aluminium  RAL9007 Grey aluminium  RAL7016 Anthracite grey  RAL9016 Traffic white
Gasket	Silicone CCG® Controlled Compression Gasket
Fasteners	PCS Polymer Coated Stainless Steel Hardware
Ingress protection	IP66
Impact resistance	IK07
Corrosion resistance	5CE
Windage	0.114 m ²

Electrical description

Power supply	220-240V / 50-60 Hz
Driver / Ballast	Standard. Optional DALI version available. To be specified at time of ordering.
Power factor	> 0.9
Surge protection	6/6 kV (optional SP10)

Additional information

Lifetime	Ta=25° L70B50 > 50000h
----------	------------------------

FLC230 LED [ZP]

Projectors

we-ef

Options

Light distribution



symmetric Zoom-Projector [ZP] - min aperture angle



symmetric Zoom-Projector [ZP] - max aperture angle

Colour temperature



2200 K



2700 K



3000 K

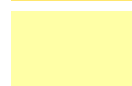



4000 K

Nominal Watt

36 W

48 W

Configurations

Light distribution	Part ID	Light source	Rated lumens	Rated input power	CRI	Weight (kg)
symmetric Zoom-Projector [ZP] - max aperture angle 	139-3011_max	LED-FT-36W / 850 mA - 2200 K	2201.3	39 W	70	10.80
	139-3012_max	LED-FT-48W / 1100 mA - 2200 K	2810.5	53 W	70	10.80
	139-3013_max	LED-FT-36W / 850 mA - 2700 K	2580.2	39 W	80	10.80
	139-3014_max	LED-FT-48W / 1100 mA - 2700 K	3294.3	53 W	80	10.80
	139-3015_max	LED-FT-36W / 850 mA - 3000 K	2603.2	39 W	80	10.80
	139-3016_max	LED-FT-48W / 1100 mA - 3000 K	3325	53 W	80	10.80
	139-3017_max	LED-FT-36W / 850 mA - 4000 K	2790.1	39 W	80	10.80
	139-3018_max	LED-FT-48W / 1100 mA - 4000 K	3563.1	53 W	80	10.80
symmetric Zoom-Projector [ZP] - min aperture angle 	139-3011_min	LED-FT-36W / 850 mA - 2200 K	2462.2	39 W	70	10.80
	139-3012_min	LED-FT-48W / 1100 mA - 2200 K	3143.6	53 W	70	10.80
	139-3013_min	LED-FT-36W / 850 mA - 2700 K	2886	39 W	80	10.80
	139-3014_min	LED-FT-48W / 1100 mA - 2700 K	3684.7	53 W	80	10.80
	139-3015_min	LED-FT-36W / 850 mA - 3000 K	2911.7	39 W	80	10.80
	139-3016_min	LED-FT-48W / 1100 mA - 3000 K	3719.1	53 W	80	10.80
	139-3017_min	LED-FT-36W / 850 mA - 4000 K	3120.7	39 W	80	10.80
	139-3018_min	LED-FT-48W / 1100 mA - 4000 K	3985.4	53 W	80	10.80

Mounting Accessories

Short post EM

Description	Part ID	D1	D2	H1	M1	Weight (kg)
EM1-M16	270-9038	160	130	200	9	2

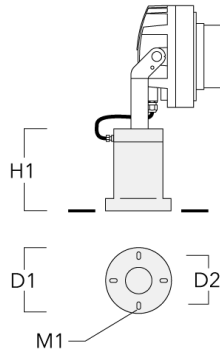

Floodlight mounting bracket TA

Description	Part ID	A	C1	D x L1	Weight (kg)	D x S
TA1 Mounting bracket, single (Ø 108 x 200)	147-0096		130	108 x 200	7.50	108 x 200

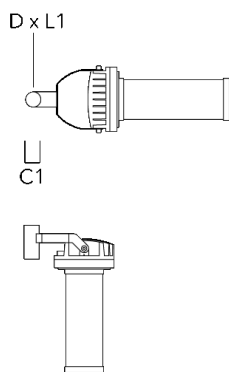

Projectors

Description	Part ID	A	C1	D × L1	Weight (kg)	D × S
TA2 Mounting bracket, double (Ø 108 x 200)	147-0097		130	108 x 200	7.50	108 x 200

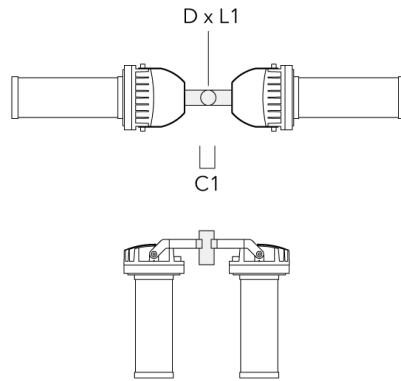

TA2-L Mounting bracket, double (Ø 108 x 200)	147-0148	±90°	420	108 x 200	20.20	108 x 200
--	----------	------	-----	-----------	-------	-----------

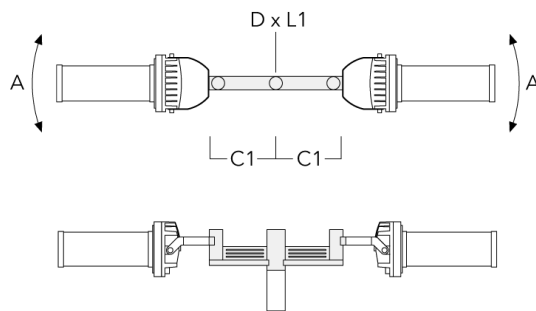

Projectors

Description	Part ID	A	C1	D x L1	Weight (kg)	D x S
TA2-L Mounting bracket, double (Ø 76 x 200)	147-0105	±90°	420	76 x 200	16.10	76 x 200

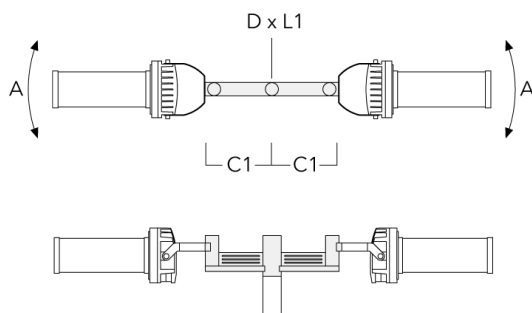

TA3 Mounting bracket, triple (Ø 89 x 200)	147-0025	±90°	650	89 x 200	17.90	89 x 200
---	----------	------	-----	----------	-------	----------

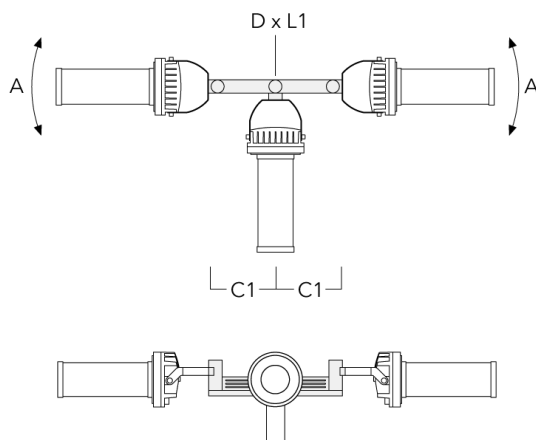

Projectors

Description	Part ID	A	C1	D x L1	Weight (kg)	D x S
TA3 Mounting bracket, triple (Ø 108 x 200)	147-0098	±90°	650	108 x 200	24.20	108 x 200

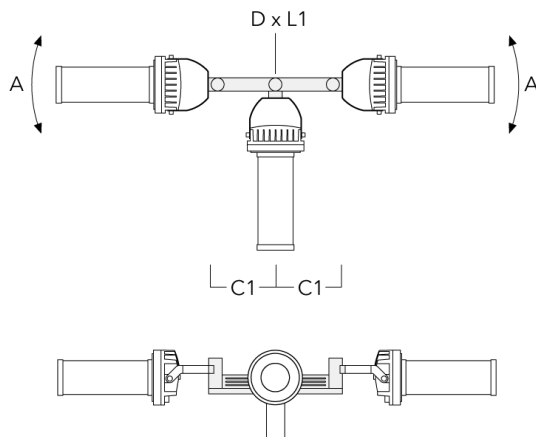

TA4 Mounting bracket, quad (Ø 89 x 200)	147-0099	±90°	650	89 x 200	20.80	89 x 200
---	----------	------	-----	----------	-------	----------

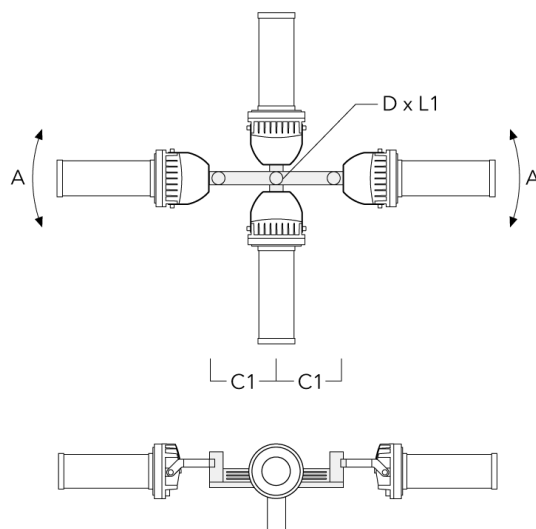

Projectors

Description	Part ID	A	C1	D × L1	Weight (kg)	D × S
TA4 Mounting bracket, quad (Ø 108 x 200)	147-0100	±90°	650	108 x 200	24.20	108 x 200



Pole clamp TS

Description	Part ID	D1	Weight (kg)	D
TS1-2/M12 Pole clamp, single (Ø 102-114)	147-0526	102-114	1.50	102-114

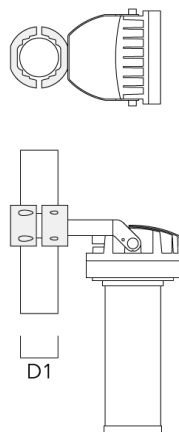

Projectors

Description	Part ID	D1	Weight (kg)	D
TS1-2/M12 Pole clamp, single (Ø 114-133)	147-0544	114-133	1.70	114-133

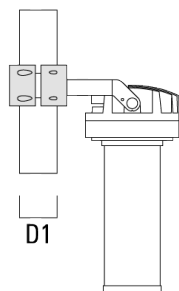
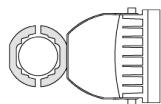

TS2-2/M12 Pole clamp, double (Ø 102-114)	147-0527	102-114	1.50	102-114
--	----------	---------	------	---------

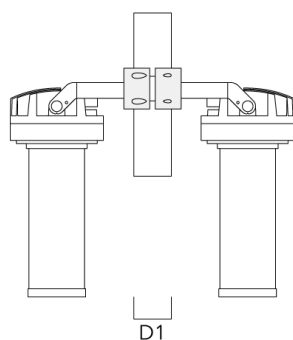
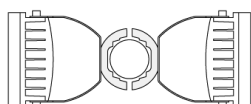

Projectors

Description	Part ID	D1	Weight (kg)	D
TS2-2/M12 Pole clamp, double (Ø 76-89)	147-0545	76-89	1.40	76-89

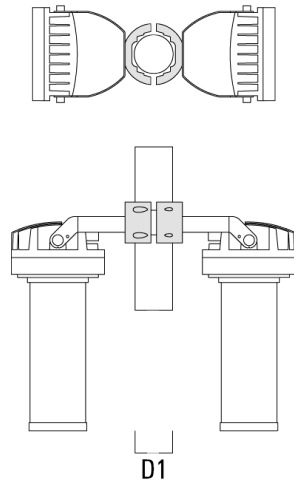

TS2-2/M12 Pole clamp, double (Ø 114-133)	147-0546	114-133	1.60	114-133
--	----------	---------	------	---------

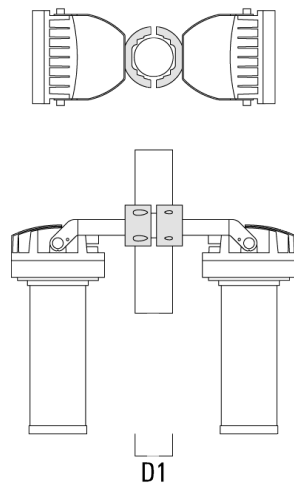

Projectors

Description	Part ID	D1	Weight (kg)	D
TS1-2/M12 Pole clamp, single (Ø 76-89)	147-0543	76-89	1.40	76-89



Planted root

Description	Part ID	D1	D2	D3	D4	H1	H2	M1	Weight (kg)
Planted root ESV4	300-0461	145	130	60	89	400	350	8	3.83



Pole clamp PC

Fagerhult Lighting Ltd

33-34 Dolben Street, SE1 0UQ London, United Kingdom

<https://we-ef.com/uk>

Subject to technical changes and errors. - Generated on 23/10/2024

Projectors

Description	Part ID	D1	Weight (kg)
PC1 76-89/60 Pole clamp, single (Ø 76-89)	139-2702	76-89	1.00

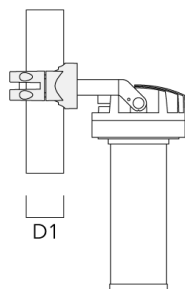
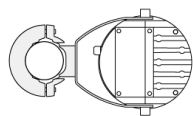

PC2 76-89/60 Pole clamp, double (Ø 76-89)	139-2703	76-89	1.00
---	----------	-------	------



Projectors

Description	Part ID	D1	Weight (kg)
PC1 82-109/60 Pole clamp, single (Ø 82-109)	139-2704	82-109	1.10

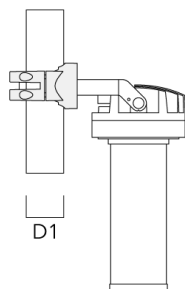
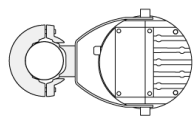

PC2 82-109/60 Pole clamp, double (Ø 82-109)	139-2705	82-109	1.10
---	----------	--------	------



Projectors

Description	Part ID	D1	Weight (kg)
PC1 102-114/60 Pole clamp, single (Ø 102-114)	139-2706	102-114	1.20



PC2 102-114/60 Pole clamp, double (Ø 102-114)	139-2707	102-114	1.20
--	----------	---------	------



Projectors

Description	Part ID	D1	Weight (kg)
PC1 114-133/60 Pole clamp, single (Ø 114-133)	139-2708	114-133	1.40

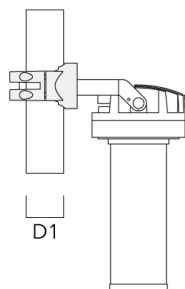
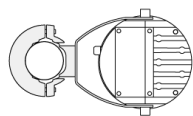

PC2 114-133/60 Pole clamp, double (Ø 114-133)	139-2709	114-133	1.40
--	----------	---------	------



Control

Eco Step Dim® Basic

Description	Part ID
Eco Step Dim® Basic LED	430-0001

Eco Step Dim® Advanced

Description	Part ID
Eco Step Dim® Advanced LED	430-0002

R2C Ready to Connect

Description	Part ID
R2C Ready to Connect (top)	430-0019

FLC230 LED [ZP]

Projectors

Fagerhult Lighting Ltd

33-34 Dolben Street, SE1 0UQ London, United Kingdom

<https://we-ef.com/uk>

Subject to technical changes and errors.
Generated on 23/10/2024