



**Beschreibung**

IP66, SKI. IK07. Korrosionsbeständiger Aluminiumguss. PCS beschichtete Edelstahlschrauben. 5CE Korrosionsschutz. CCG® Silikondichtung. Sicherheitsglas. Eine Kabelverschraubung, eine zweite Kabelverschraubung zur Durchverdrahtung auf Anfrage. Eingebaute elektronische Betriebsgeräte, thermisch getrennt. CAD-optimierte OLC® One LED Concept Technik zur Lichtlenkung und Entblendung. Eingebaute LED Platine. 1-10V, DALI Schnittstelle oder Eco Step Dim® auf Anfrage. Maximal ein internes Zubehörteil möglich.

Variante mit 2200 K erhältlich, bei Bestellung bitte angeben.

Spezifikationen**Materialbeschreibung**

Gehäuse	Korrosionsbeständiges Aluminium
Abdeckung	Sicherheitsglasscheibe
Farben	 RAL9004 Signalschwarz  RAL9007 Graualuminium  RAL7016 Anthrazitgrau  RAL9016 Verkehrsweiß
Dichtung	CCG® Silikondichtung
Schrauben	PCS beschichtete Edelstahlschrauben
Schutzart	IP66
Schlagfestigkeit	IK07
Korrosionsbeständigkeit	5CE
Windangriffsfläche	0.030 m ²

Elektrische Beschreibung

Netz	220-240V / 50-60 Hz
Netzgerät / Vorschaltgerät	Standard. Variante mit DALI erhältlich, bei Bestellung bitte angeben.
Überspannungsschutz	6/6 kV (optional SP10)

Weitere Informationen

Lebensdauer	Ta=25° L90B10 > 90000h
Energieeffizienzklasse	C-D (Lichtquelle)

Auswahl

Lichtverteilung



symmetrisch breitstrahlend [B]



symmetrisch mediumstrahlend [M]



symmetric, narrow beam [E]



symmetrisch extrem engstrahlend [EE]



symmetrisch extrem engstrahlend, 'sharp cut-off' [EES]



wallwash



bandförmig extrem engstrahlend [EE]



bandförmig extrem engstrahlend, 'sharp cut-off' [EES]

Farbtemperaturen



3000 K



4000 K





2700 K

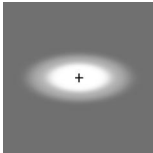
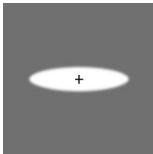

Nominal Watt

0 W

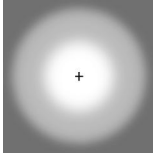
Konfigurationen

Lichtverteilung	Artikelnummer	Lichtquelle	Bemes- sungslicht- strom	Bemes- sungsleis- tung	CRI	Gewicht (kg)
bandförmig extrem engstrahlend [EE] 	139-2005+139-2036	LED-6/12W / 700 mA - 3000 K	1487	14.5 W	80	4.30
	139-2006+139-2036	LED-6/12W / 700 mA - 4000 K	1589.5	14.5 W	80	4.30
	139-2015+139-2036	LED-6/18W / 1050 mA - 3000 K	2204.8	21 W	80	4.30
	139-2016+139-2036	LED-6/18W / 1050 mA - 4000 K	2307.4	21 W	80	4.30
	139-2030+139-2036	LED-6/26W / 1400 mA - 3000 K	2712.7	29 W	80	4.30
	139-2031+139-2036	LED-6/26W / 1400 mA - 4000 K	2836	29 W	80	4.30
	139-2261+139-2036	LED-6/12W / 700 mA - 2700 K	1384.4	14.5 W	80	4.30
	139-2269+139-2036	LED-6/18W / 1050 mA - 2700 K	2102.3	21 W	80	4.30
	139-2276+139-2036	LED-6/26W / 1400 mA - 2700K	2564.7	29 W	80	4.30
bandförmig extrem engstrahlend, 'sharp cut-off' [EES] 	139-2007+139-2036	LED-6/12W / 700 mA - 3000 K	1203.4	14.5 W	80	4.30
	139-2008+139-2036	LED-6/12W / 700 mA - 4000 K	1349.3	14.5 W	80	4.30
	139-2017+139-2036	LED-6/18W / 1050 mA - 3000 K	1729.2	21 W	80	4.30
	139-2018+139-2036	LED-6/18W / 1050 mA - 4000 K	1938.8	21 W	80	4.30
	139-2032+139-2036	LED-6/26W / 1400 mA - 3000 K	2128.7	29 W	80	4.30
	139-2033+139-2036	LED-6/26W / 1400 mA - 4000 K	2384	29 W	80	4.30
	139-2262+139-2036	LED-6/12W / 700 mA - 2700 K	1131	14.5 W	80	4.30
	139-2270+139-2036	LED-6/18W / 1050 mA - 2700 K	1624.4	21 W	80	4.30
	139-2277+139-2036	LED-6/26W / 1400 mA - 2700 K	1997.7	29 W	80	4.30
symmetric, narrow beam [E] 	139-2003	LED-6/12W / 700 mA - 3000 K	1473.8	14.5 W	80	4.30
	139-2004	LED-6/12W / 700 mA - 4000 K	1575.5	14.5 W	80	4.30
	139-2013	LED-6/18W / 1050 mA - 3000 K	2185.4	21 W	80	4.30
	139-2014	LED-6/18W / 1050 mA - 4000 K	2287	21 W	80	4.30
	139-2028	LED-6/26W / 1400 mA - 3000 K	2711.6	29 W	80	4.30
	139-2029	LED-6/26W / 1400 mA - 4000 K	2834.8	29 W	80	4.30
	139-2224	LED-6/26W / 1400 mA - 2700K	2563.7	29 W	80	4.30
	139-2245	LED-6/18W / 1050 mA - 2700 K	2083.7	21 W	80	4.30
	139-2248	LED-6/12W / 700 mA - 2700 K	1372.2	14.5 W	80	4.30
	symmetrisch breitstrahlend [B] 	139-1999	LED-6/12W / 700 mA - 3000 K	1492	14.5 W	80
139-2000		LED-6/12W / 700 mA - 4000 K	1594.9	14.5 W	80	4.30
139-2009		LED-6/18W / 1050 mA - 3000 K	2212.3	21 W	80	4.30
139-2010		LED-6/18W / 1050 mA - 4000 K	2315.2	21 W	80	4.30
139-2024		LED-6/26W / 1400 mA - 3000 K	2744.9	29 W	80	4.30
139-2025		LED-6/26W / 1400 mA - 4000 K	2869.7	29 W	80	4.30
139-2186		LED-6/26W / 1400 mA - 2700K	2675.4	29 W	80	4.30

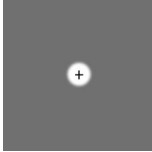
Scheinwerfer symmetrisch

Lichtverteilung	Artikelnummer	Lichtquelle	Bemes- sungslicht- strom	Bemes- sungsleis- tung	CRI	Gewicht (kg)
symmetrisch extrem engstrahlend [EE] 	139-2243	LED-6/18W / 1050 mA - 2700 K	2109.4	21 W	80	4.30
	139-2246	LED-6/12W / 700 mA - 2700 K	1389.1	14.5 W	80	4.30
	139-2005	LED-6/12W / 700 mA - 3000 K	1559.6	14.5 W	80	4.30
	139-2006	LED-6/12W / 700 mA - 4000 K	1667.2	14.5 W	80	4.30
	139-2015	LED-6/18W / 1050 mA - 3000 K	2312.6	21 W	80	4.30
	139-2016	LED-6/18W / 1050 mA - 4000 K	2420.1	21 W	80	4.30
	139-2030	LED-6/26W / 1400 mA - 3000 K	2869.2	29 W	80	4.30
	139-2031	LED-6/26W / 1400 mA - 4000 K	2999.6	29 W	80	4.30
	139-2261	LED-6/12W / 700 mA - 2700 K	1452.1	14.5 W	80	4.30
	139-2269	LED-6/18W / 1050 mA - 2700 K	2205	21 W	80	4.30
139-2276	LED-6/26W / 1400 mA - 2700K	2712.7	29 W	80	4.30	
symmetrisch extrem engstrahlend, 'sharp cut-off' [EES] 	139-2007	LED-6/12W / 700 mA - 3000 K	1234.8	14.5 W	80	4.30
	139-2008	LED-6/12W / 700 mA - 4000 K	1384.4	14.5 W	80	4.30
	139-2017	LED-6/18W / 1050 mA - 3000 K	1774.2	21 W	80	4.30
	139-2018	LED-6/18W / 1050 mA - 4000 K	1989.3	21 W	80	4.30
	139-2032	LED-6/26W / 1400 mA - 3000 K	2203.5	29 W	80	4.30
	139-2033	LED-6/26W / 1400 mA - 4000 K	2467.7	29 W	80	4.30
	139-2262	LED-6/12W / 700 mA - 2700 K	1160.4	14.5 W	80	4.30
	139-2270	LED-6/18W / 1050 mA - 2700 K	1666.7	21 W	80	4.30
	139-2277	LED-6/26W / 1400 mA - 2700 K	2067.9	29 W	80	4.30
	symmetrisch mediumstrahlend [M] 	139-2001	LED-6/12W / 700 mA - 3000 K	1533.6	14.5 W	80
139-2002		LED-6/12W / 700 mA - 4000 K	1639.3	14.5 W	80	4.30
139-2011		LED-6/18W / 1050 mA - 3000 K	2273.9	21 W	80	4.30
139-2012		LED-6/18W / 1050 mA - 4000 K	2379.6	21 W	80	4.30
139-2026		LED-6/26W / 1400 mA - 3000 K	2821.4	29 W	80	4.30
139-2027		LED-6/26W / 1400 mA - 4000 K	2949.6	29 W	80	4.30
139-2187		LED-6/26W / 1400 mA - 2700K	2667.5	29 W	80	4.30
139-2244		LED-6/18W / 1050 mA - 2700 K	2168.1	21 W	80	4.30
139-2247		LED-6/12W / 700 mA - 2700 K	1427.8	14.5 W	80	4.30
wallwash 		139-2001+139-2035-AP	LED-6/12W / 700 mA - 3000 K	1285.2	14.5 W	80
	139-2002+139-2035-AP	LED-6/12W / 700 mA - 4000 K	1373.8	14.5 W	80	4.30
	139-2011+139-2035-AP	LED-6/18W / 1050 mA - 3000 K	1905.6	21 W	80	4.30
	139-2012+139-2035-AP	LED-6/18W / 1050 mA - 4000 K	1994.3	21 W	80	4.30
	139-2026+139-2035-AP	LED-6/26W / 1400 mA - 3000 K	2364.4	29 W	80	4.30
	139-2027+139-2035-AP	LED-6/26W / 1400 mA - 4000 K	2471.8	29 W	80	4.30

Scheinwerfer symmetrisch

Lichtverteilung	Artikelnummer	Lichtquelle	Bemes- sungslicht- strom	Bemes- sungsleis- tung	CRI	Gewicht (kg)
	139-2187+139-2035-AP	LED-6/26W / 1400 mA - 2700K	2235.4	29 W	80	4.30
	139-2244+139-2035-AP	LED-6/18W / 1050 mA - 2700 K	1817	21 W	80	4.30
	139-2247+139-2035-AP	LED-6/12W / 700 mA - 2700 K	1196.6	14.5 W	80	4.30

Montagezubehör

Montagesockel EM

Beschreibung	Artikelnummer	D1	D2	H1	M1	Gewicht (kg)
EM1-M16 AL	270-9038	160	130	203	9	2

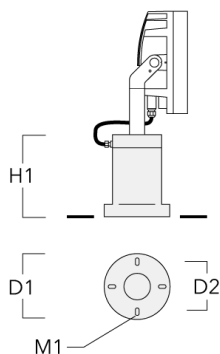

Mastaufsatztraverse TA

Beschreibung	Artikelnummer	A	C1	D x L1	Gewicht (kg)	D x S
TA1 Mastaufsatztraverse, einfach (Ø 108 x 200)	147-0096		130	108 x 200	7.50	108 x 200

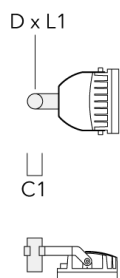

Scheinwerfer symmetrisch

Beschreibung	Artikelnummer	A	C1	D × L1	Gewicht (kg)	D × S
TA2 Mastaufsatztraverse, zweifach (Ø 108 x 200)	147-0097		130	108 x 200	7.50	108 x 200

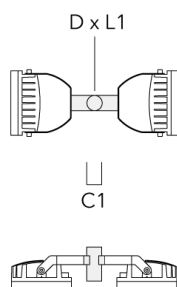

TA3 Mastaufsatztraverse, dreifach (Ø 89 x 200)	147-0025	±90°	650	89 x 200	17.90	89 x 200
--	----------	------	-----	----------	-------	----------

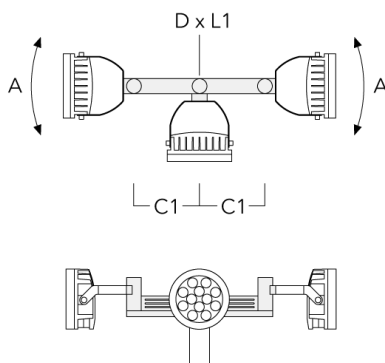

Scheinwerfer symmetrisch

Beschreibung	Artikelnummer	A	C1	D × L1	Gewicht (kg)	D × S
TA3 Mastaufsatztraverse, dreifach (Ø 108 x 200)	147-0098	±90°	650	108 x 200	24.20	108 x 200

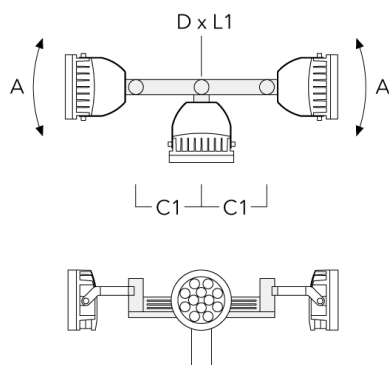

TA2 Mastaufsatztraverse, zweifach (Ø 76 x 200)	147-0024		130	76 x 200	1.90	76 x 200
--	----------	--	-----	----------	------	----------

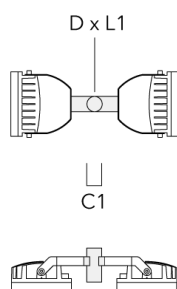

Scheinwerfer symmetrisch

Beschreibung	Artikelnummer	A	C1	D × L1	Gewicht (kg)	D × S
TA1 Mastaufsatztraverse, einfach* (Ø 76 x 200)	147-0023		130	76 x 200	1.50	76 x 200

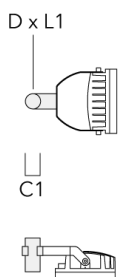

Mastschelle TS

Beschreibung	Artikelnummer	D1	Gewicht (kg)	D
TS1-2/M12 Mastschelle, einfach (Ø 102-114)	147-0526	102-114	1.50	102-114

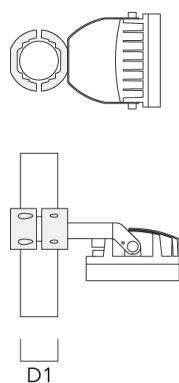

Scheinwerfer symmetrisch

Beschreibung	Artikelnummer	D1	Gewicht (kg)	D
TS1-2/M12 Mastschelle, einfach (Ø 114-133)	147-0544	114-133	1.70	114-133

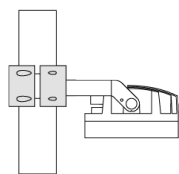
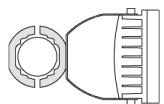

D1

TS1-2/M12 Mastschelle, einfach (Ø 76-89)	147-0543	76-89	1.40	76-89
--	----------	-------	------	-------

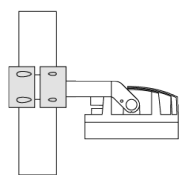
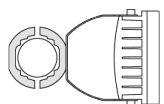

D1

Scheinwerfer symmetrisch

Beschreibung	Artikelnummer	D1	Gewicht (kg)	D
TS2-2/M12 Mastschelle, zweifach (Ø 76-89)	147-0545	76-89	1.40	76-89

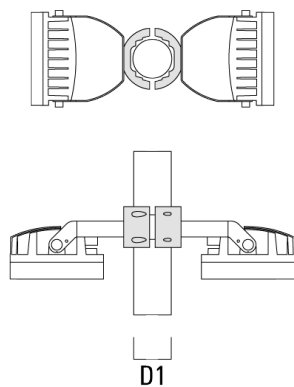

TS2-2/M12 Mastschelle, zweifach (Ø 114-133)	147-0546	114-133	1.60	114-133
---	----------	---------	------	---------

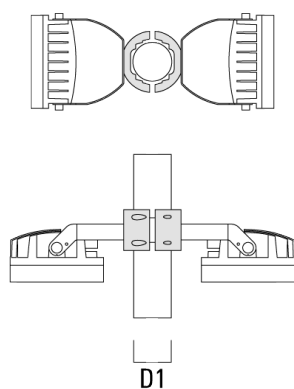

Scheinwerfer symmetrisch

Beschreibung	Artikelnummer	D1	Gewicht (kg)	D
TS2-2/M12 Mastschelle, zweifach (Ø 102-114)	147-0527	102-114	1.50	102-114

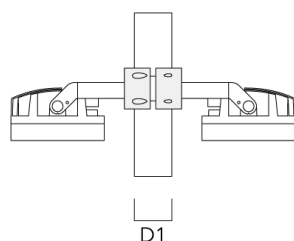
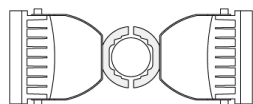

Mastschelle PC

Beschreibung	Artikelnummer	D1	Gewicht (kg)
PC2 76-89/60 Mastschelle, zweifach (Ø 76-89)	139-2703	76-89	1.00

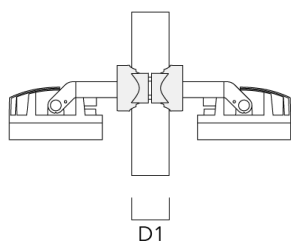
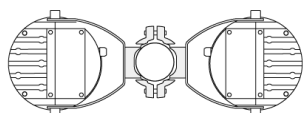

Scheinwerfer symmetrisch

Beschreibung	Artikelnummer	D1	Gewicht (kg)
PC1 76-89/60 Mastschelle, einfach (Ø 76-89)	139-2702	76-89	1.00

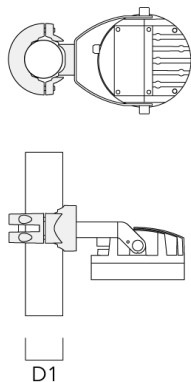

PC2 102-114/60 Mastschelle, zweifach (Ø 102-114)	139-2707	102-114	1.20
--	----------	---------	------

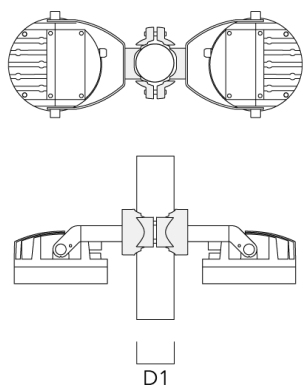

Scheinwerfer symmetrisch

Beschreibung	Artikelnummer	D1	Gewicht (kg)
PC1 102-114/60 Mastschelle, einfach (Ø 102-114)	139-2706	102-114	1.20

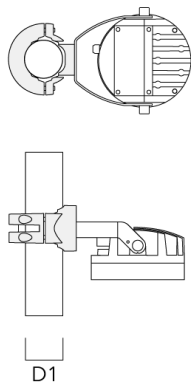

PC2 114-133/60 Mastschelle, zweifach (Ø 114-133)	139-2709	114-133	1.40
---	----------	---------	------

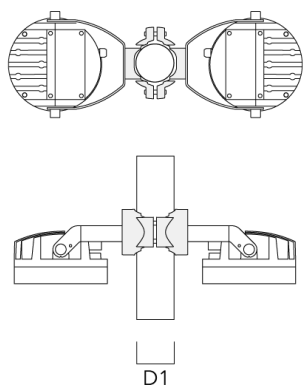

Scheinwerfer symmetrisch

Beschreibung	Artikelnummer	D1	Gewicht (kg)
PC1 114-133/60 Mastschelle, einfach (Ø 114-133)	139-2708	114-133	1.40

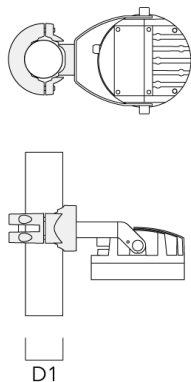

PC2 82-109/60 Mastschelle, zweifach (Ø 82-109)	139-2705	82-109	1.10
---	----------	--------	------

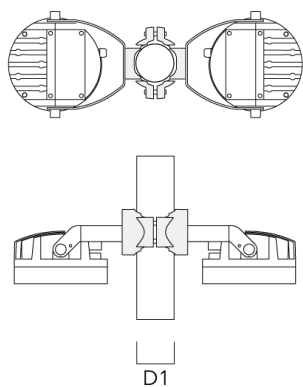

Scheinwerfer symmetrisch

Beschreibung	Artikelnummer	D1	Gewicht (kg)
PC1 82-109/60 Mastschelle, einfach (Ø 82-109)	139-2704	82-109	1.10

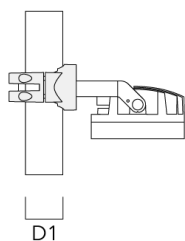
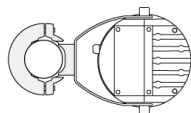

Optisches Zubehör**Wallwash Linse**

Beschreibung	Artikelnummer	C1
IO-20-FLC220-LED	139-2035	146

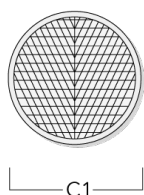

Streulinse bandförmig

Beschreibung	Artikelnummer	C1
IO-180-FLC220-LED	139-2036	146

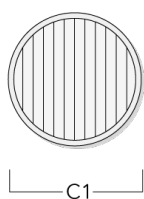

FLC220 LED

Scheinwerfer symmetrisch

Streulinse allseitig

Beschreibung	Artikelnummer	C1
IO-360-FLC220-LED	139-2037	146

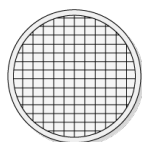

C1

Wabenblende

Beschreibung	Artikelnummer	C1
IW-FLC220-LED - [EE][EES]	139-2034	138

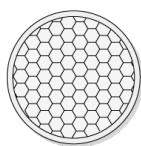

C1

WE-EF Switzerland AG

Himmelrichstrasse 6, 6003 Luzern - Tel: +41 41 210 49 95

info.switzerland@we-ef.com - https://we-ef.com/ch_de

Technische Änderungen und Irrtümer vorbehalten. - Erstellt am 23.11.2024

Scheinwerfer symmetrisch**Seitenblende**

Beschreibung	Artikelnummer	A	C1
ES-FLC220-LED	139-1986	125	190

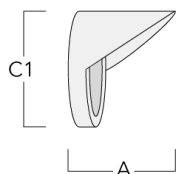

Abblendtubus

Beschreibung	Artikelnummer	A	C1
ET-FLC220-LED	139-1987	125	190

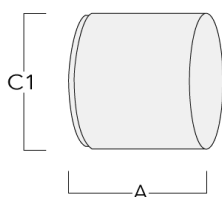

FLC220 LED

Scheinwerfer symmetrisch



Steuerung

R2C Ready to Connect

Beschreibung	Artikelnummer
R2C Ready to Connect (oben)	430-0019

WE-EF Switzerland AG

Himmelrichstrasse 6, 6003 Luzern - Tel: +41 41 210 49 95

info.switzerland@we-ef.com - https://we-ef.com/ch_de

Technische Änderungen und Irrtümer vorbehalten. - Erstellt am 23.11.2024