



### Description

IP66, Class I. IK07. Marine-grade, die-cast aluminium alloy. 5CE superior corrosion protection + primer including PCS hardware. Silicone CCG® Controlled Compression Gasket. Safety glass lens. Two cable glands for improved wiring flexibility. Integral EC electronic converter, thermally separated. CAD-optimised optics for superior illumination and glare control. OLC® One LED Concept. Factory-installed LED circuit board with Tunable White Technology. DALI Interface.

**Projectors****Specifications****Material description**

---

Body	Marine-grade, die-cast aluminium alloy
Lens	Safety glass lens
Colours	 RAL9004 Signal black  RAL9006 White aluminium  RAL9007 Grey aluminium
Gasket	Silicone CCG® Controlled Compression Gasket
Fasteners	PCS Polymer Coated Stainless Steel Hardware (unpainted)
Ingress protection	IP66
Impact resistance	IK07
Corrosion resistance	5CE+Primer
Windage	0.054 m <sup>2</sup>

---

**Electrical description**

---

Power supply	230V / 50 Hz
Driver / Ballast	DALI

---

**Additional information**

---

Lifetime	Ta=40° L90B10 > 90000h
Warranty	The product is supplied with 10-year warranty. Please refer to the LED Warranty Statement located on <a href="http://www.we-ef.com">www.we-ef.com</a> for further details.

---

### Options

#### Light distribution



symmetric, wide beam [B]



symmetric, medium beam [M]



symmetric, narrow beam [E]



linear spread, narrow beam [E]



wallwash



symmetric, very narrow beam, sharp cut-off [EES]

#### Colour temperature





2200-6000K

2700-6000K

#### Nominal Watt

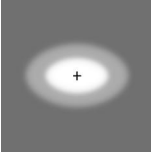
0 W

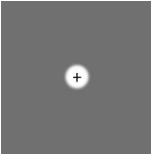
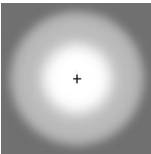
### Configurations

Light distribution	Part ID	Light source	Rated lumens	Rated input power	CRI	Weight (kg)
linear spread, narrow beam [E] 	139-2135+139-1849	LED-12/44W - 2200-6000 K	3835.7	51 W	80	7.70
symmetric, medium beam [M] 	139-2045	LED-12/44W - 2200-6000 K	4058	51 W	80	7.70
symmetric, narrow beam [E] 	139-2135	LED-12/44W - 2200-6000 K	4128.9	51 W	80	7.70
symmetric, very narrow beam, sharp cut-off [EES] 	139-2423	LED-24/24W - 2700-6000 K	2129	26.5 W	80	7.70
symmetric, wide beam [B] 	139-2044	LED-12/44W - 2200-6000 K	3815.8	51 W	80	7.70
wallwash 	139-2045+139-1848	LED-12/44W - 2200-6000 K	3343.1	51 W	80	7.70

**Mounting Accessories**

**Floodlight mounting bracket TA**

Description	Part ID	A	C1	D x L1	Weight (kg)	D x S
TA2-L Mounting bracket, double (Ø 76 x 200)	147-0105	±90°	420	76 x 200	16.10	76 x 200

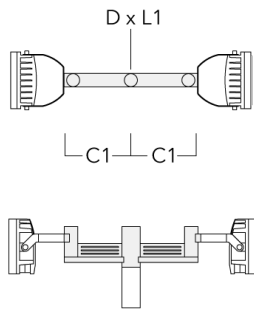

TA2 Mounting bracket, double* (Ø 76 x 200)	147-0024		130	76 x 200	1.90	76 x 200
--	----------	--	-----	----------	------	----------

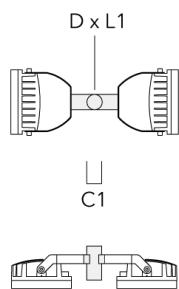

**Projectors**

**Planted root**

Description	Part ID	D1	D2	D3	D4	H1	H2	M1	T1	T2	Weight (kg)
Planted root ESV4	300-0461-AP	150	130	60	89	400	350	8	200	50 x 100	3.85

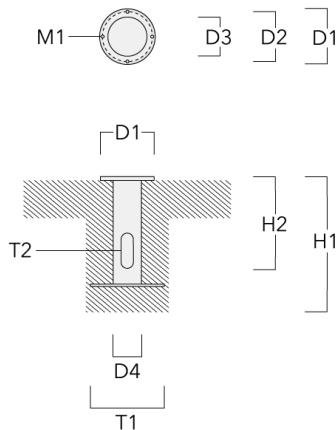

**Spigot cap KF**

Description	Part ID	D1	Weight (kg)	D
KF1-60/M16	310-9120	60x100	2.00	60 x 100

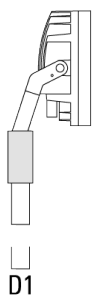

## Projectors

Description	Part ID	D1	Weight (kg)	D
KF1-76/M16	310-9121	76 x 100	2.00	76 x 100

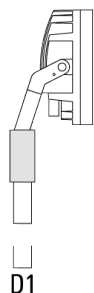

## Pole clamp PC - Rotatable

Description	Part ID	D1	Weight (kg)
PC2 76-89/60 Pole clamp, double (Ø 76-89)	139-2703	76-89	1.00

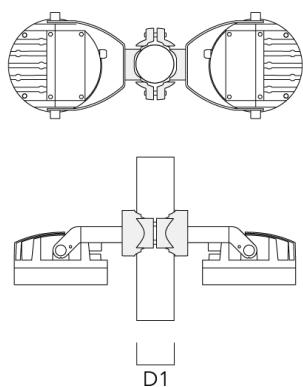

## Projectors

Description	Part ID	D1	Weight (kg)
PC1 76-89/60 Pole clamp, single (Ø 76-89)	139-2702	76-89	1.00

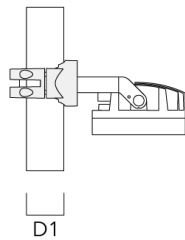
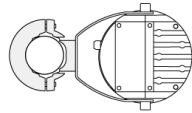

PC2 102-114/60 Pole clamp, double (Ø 102-114)	139-2707	102-114	1.20
---	----------	---------	------

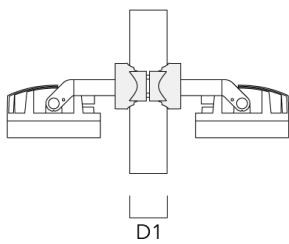
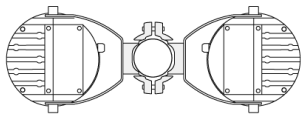



## Projectors

Description	Part ID	D1	Weight (kg)
PC1 102-114/60 Pole clamp, single (Ø 102-114)	139-2706	102-114	1.20

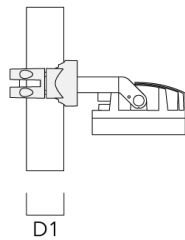
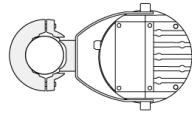

PC2 114-133/60 Pole clamp, double (Ø 114-133)	139-2709	114-133	1.40
--	----------	---------	------

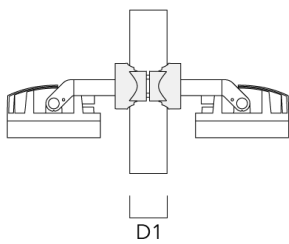
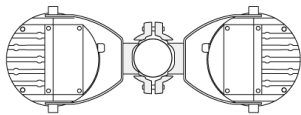

## Projectors

Description	Part ID	D1	Weight (kg)
PC1 114-133/60 Pole clamp, single (Ø 114-133)	139-2708	114-133	1.40

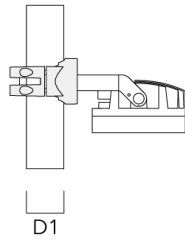
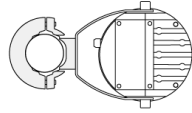

PC2 82-109/60 Pole camp, double (Ø 82-109)	139-2705	82-109	1.10
--	----------	--------	------

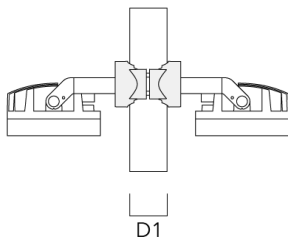
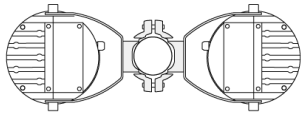

## Projectors

Description	Part ID	D1	Weight (kg)
PC1 82-109/60 Pole camp, single (Ø 82-109)	139-2704	82-109	1.10

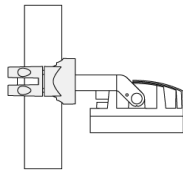
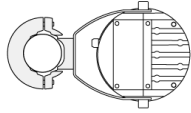

D1

**Optical Accessories**

**Linear spread lens**

---

Description	Part ID	C1
IO-180-FLC230-LED	139-1849	199

---

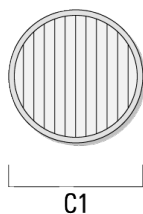

---

**Surface wash lens**

---

Description	Part ID	C1
IO-360-FLC230-LED	139-1850	199

---

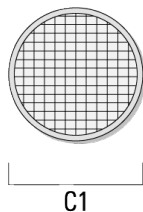

**Projectors****Glare shield**

---

Description	Part ID	A	C1
ES-FLC230-LED	139-1852	159	266

---

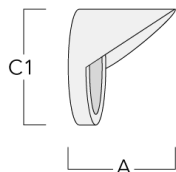

---

**Snoot**

---

Description	Part ID	A	C1
ET-FLC230-LED	139-1853	160	266

---

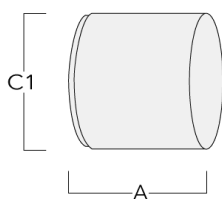

**Projectors**

**Wallwash lens**

---

Description	Part ID	C1
Wallwash lens IO-20°	139-1848	199

---

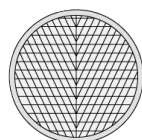

C1

**Control**

**R2C Ready to Connect**

---

Description	Part ID
R2C Ready to Connect (top)	430-0019

---