

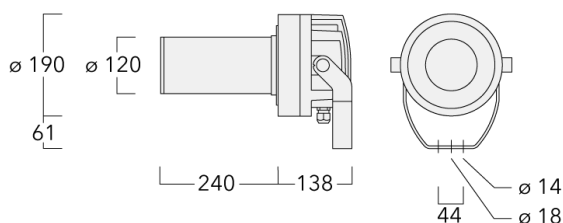

Description





Profile Projector [GP] for projection of gobos on a surface. Spherical and aspherical, double flat convex lens system. Gobo motif on request, to be ordered separately.



IP66, Class I. IK07. Marine-grade, die-cast aluminium alloy. 5CE superior corrosion protection including PCS hardware. Silicone CCG® Controlled Compression Gasket. Safety glass main lens. One cable gland. Second gland for through wiring on request. PMMA LED lens array. Factory installed LED circuit board. LED board can be removed for upgrading. Integral EC electronic converter, thermally separated.

Gobo outside diameter 66 mm, max. printable area $d = 48$ mm. WE-EF recommendation = $d 38$ mm.

Projectors**Specifications****Material description**

Body	Marine-grade, die-cast aluminium alloy
Lens	Safety glass lens
Colours	 RAL9004 Signal black  RAL9006 White aluminium  RAL9007 Grey aluminium  RAL7016 Anthracite grey  RAL9016 Traffic white
Gasket	Silicone CCG® Controlled Compression Gasket
Fasteners	PCS Polymer Coated Stainless Steel Hardware
Ingress protection	IP66
Impact resistance	IK07
Corrosion resistance	5CE
Windage	0.06 m ²

Electrical description

Power supply	220-240V / 50-60 Hz
Driver / Ballast	Standard. Optional DALI version available. To be specified at time of ordering.
Power factor	> 0.9
Surge protection	6/6 kV (optional SP10)

Additional information

Lifetime	Ta=25° L70B50 > 50000h
Energy efficiency class	F (Light source)

FLC220 LED [GP]

Projectors

we-ef

Options

Light distribution



symmetric Gobo-Projector [GP] - min aperture angle



symmetric Gobo-Projector [GP] - max aperture angle

Colour temperature



3000 K



4000 K





2700 K

Nominal Watt

0 W

Configurations

Light distribution	Part ID	Light source	Rated lumens	Rated input power	CRI	Weight (kg)
symmetric Gobo-Projector [GP] - max aperture angle 	139-2116_max	LED-FT-37W / 1050 mA - 3000 K	1383.2	42 W	80	8.20
	139-2124_max	LED-FT-37W / 1050 mA - 4000 K	1442	42 W	80	8.20
	139-2128_max	LED-FT-24W / 700 mA - 3000 K	1019.7	27 W	80	8.20
	139-2129_max	LED-FT-24W / 700 mA - 4000 K	1063.9	27 W	80	8.20
	139-2509_max	LED-FT-24W / 700 mA - 2700 K	990.3	27 W	80	8.20
	139-2512_max	LED-FT-37W / 1050 mA - 2700 K	1343.5	42 W	80	8.20
symmetric Gobo-Projector [GP] - min aperture angle 	139-2116_min	LED-FT-37W / 1050 mA - 3000 K	1339.3	42 W	80	8.20
	139-2124_min	LED-FT-37W / 1050 mA - 4000 K	1396.3	42 W	80	8.20
	139-2128_min	LED-FT-24W / 700 mA - 3000 K	987.4	27 W	80	8.20
	139-2129_min	LED-FT-24W / 700 mA - 4000 K	1030.1	27 W	80	8.20
	139-2509_min	LED-FT-24W / 700 mA - 2700 K	958.9	27 W	80	8.20
	139-2512_min	LED-FT-37W / 1050 mA - 2700 K	1300.8	42 W	80	8.20

Mounting Accessories

Short post EM

Description	Part ID	D1	D2	H1	M1	Weight (kg)
EM1-M16	270-9038	160	130	200	9	2

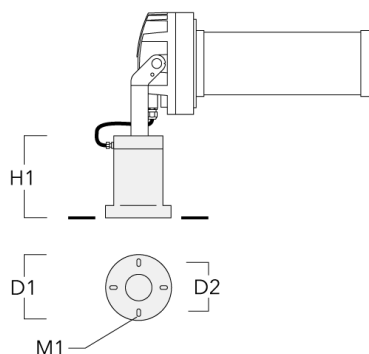

Floodlight mounting bracket TA

Description	Part ID	A	C1	D x L1	Weight (kg)	D x S
TA1 Mounting bracket, single (Ø 108 x 200)	147-0096		130	108 x 200	7.50	108 x 200

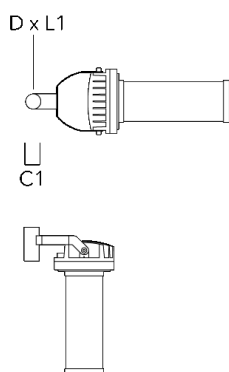

Projectors

Description	Part ID	A	C1	D × L1	Weight (kg)	D × S
TA2 Mounting bracket, double (Ø 108 x 200)	147-0097		130	108 x 200	7.50	108 x 200

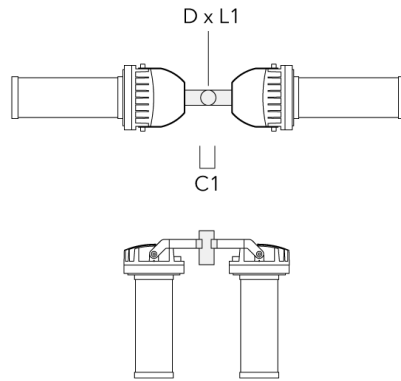

TA2-L Mounting bracket, double (Ø 76 x 200)	147-0105	±90°	420	76 x 200	16.10	76 x 200
---	----------	------	-----	----------	-------	----------

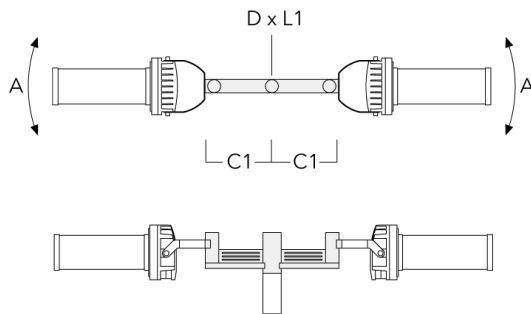

Projectors

Description	Part ID	A	C1	D × L1	Weight (kg)	D × S
TA3 Mounting bracket, triple (Ø 89 x 200)	147-0025	±90°	650	89 x 200	17.90	89 x 200

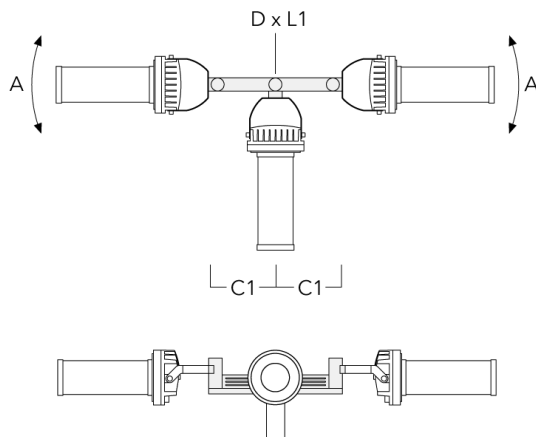

TA3 Mounting bracket, triple (Ø 108 x 200)	147-0098	±90°	650	108 x 200	24.20	108 x 200
--	----------	------	-----	-----------	-------	-----------

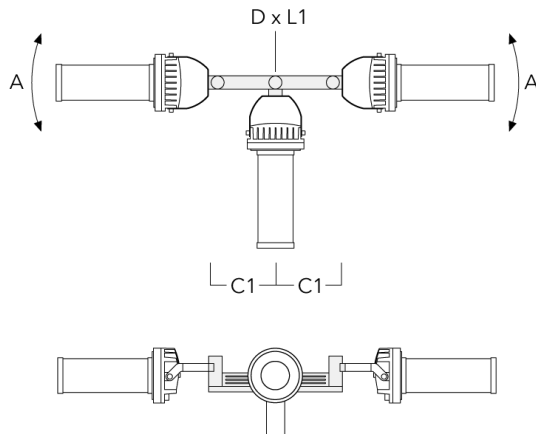

Projectors

Description	Part ID	A	C1	D x L1	Weight (kg)	D x S
TA4 Mounting bracket, quad (Ø 89 x 200)	147-0099	±90°	650	89 x 200	20.80	89 x 200

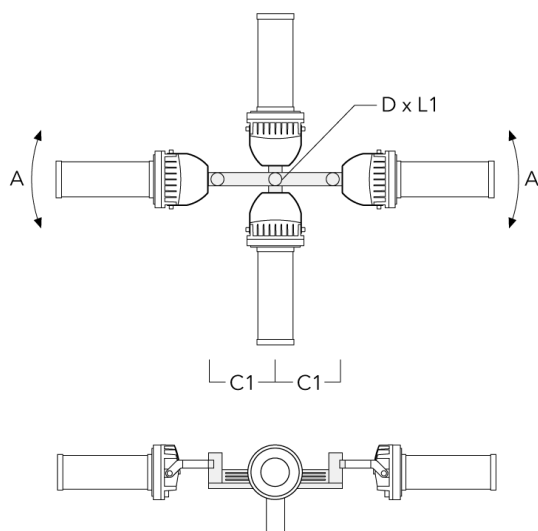

TA4 Mounting bracket, quad (Ø 108 x 200)	147-0100	±90°	650	108 x 200	24.20	108 x 200
--	----------	------	-----	-----------	-------	-----------

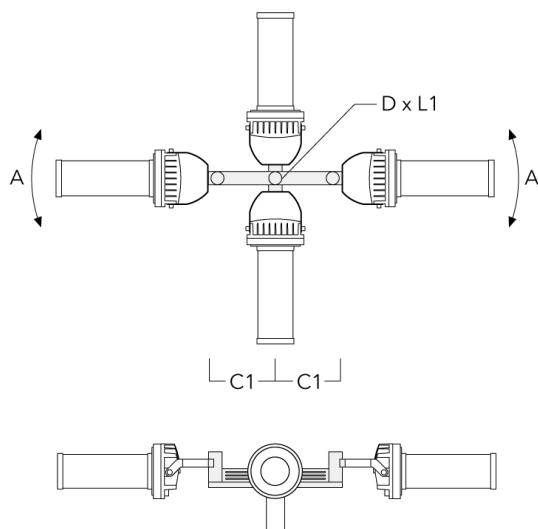

Pole clamp TS

WE-EF LEUCHTEN GmbH

Töpinger Straße 16, 29646 Bispingen, Germany - Phone: +49 5194 909-0

info@we-ef.com - <https://we-ef.com>

Subject to technical changes and errors. - Generated on 22/10/2024

Projectors

Description	Part ID	D1	Weight (kg)	D
TS1-2/M12 Pole clamp, single (Ø 102-114)	147-0526	102-114	1.50	102-114

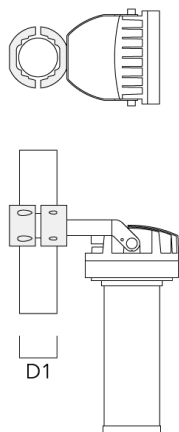

TS1-2/M12 Pole clamp, single (Ø 114-133)	147-0544	114-133	1.70	114-133
--	----------	---------	------	---------

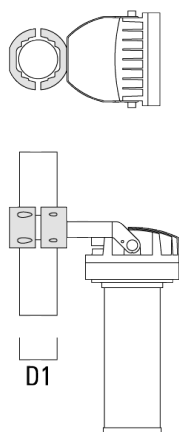

Projectors

Description	Part ID	D1	Weight (kg)	D
TS2-2/M12 Pole clamp, double (Ø 102-114)	147-0527	102-114	1.50	102-114

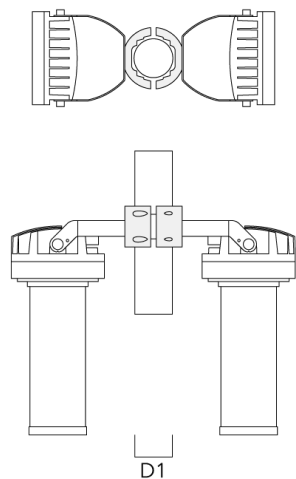

TS2-2/M12 Pole clamp, double (Ø 76-89)	147-0545	76-89	1.40	76-89
--	----------	-------	------	-------

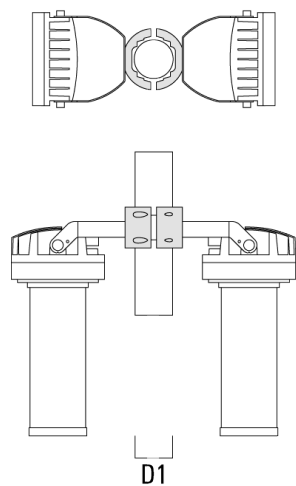

Projectors

Description	Part ID	D1	Weight (kg)	D
TS2-2/M12 Pole clamp, double (Ø 114-133)	147-0546	114-133	1.60	114-133

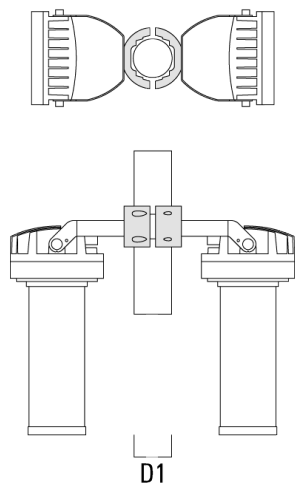

TS1-2/M12 Pole clamp, single (Ø 76-89)	147-0543	76-89	1.40	76-89
--	----------	-------	------	-------

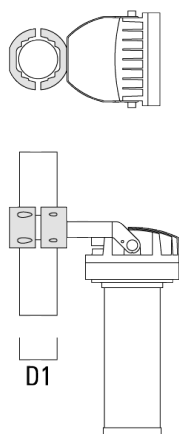

Pole clamp PC

WE-EF LEUCHTEN GmbH

Töpinger Straße 16, 29646 Bispingen, Germany - Phone: +49 5194 909-0

info@we-ef.com - <https://we-ef.com>

Subject to technical changes and errors. - Generated on 22/10/2024

Projectors

Description	Part ID	D1	Weight (kg)
PC1 76-89/60 Pole clamp, single (Ø 76-89)	139-2702	76-89	1.00

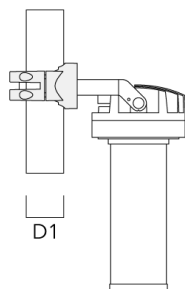
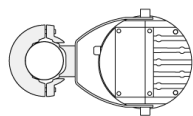

PC2 76-89/60 Pole clamp, double (Ø 76-89)	139-2703	76-89	1.00
---	----------	-------	------

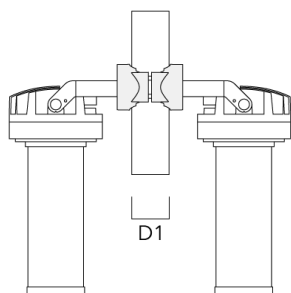
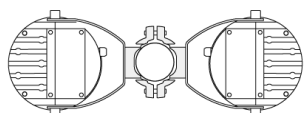

Projectors

Description	Part ID	D1	Weight (kg)
PC1 82-109/60 Pole clamp, single (Ø 82-109)	139-2704	82-109	1.10

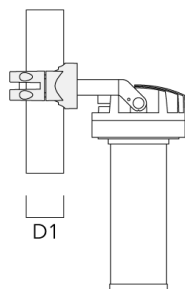
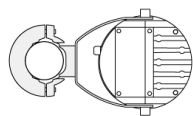

PC2 82-109/60 Pole clamp, double (Ø 82-109)	139-2705	82-109	1.10
---	----------	--------	------

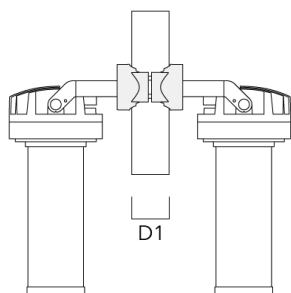
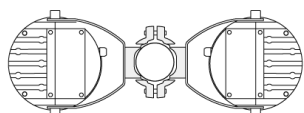

Projectors

Description	Part ID	D1	Weight (kg)
PC1 102-114/60 Pole clamp, single (Ø 102-114)	139-2706	102-114	1.20

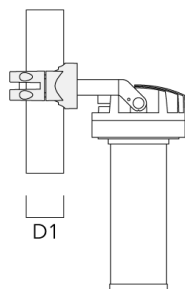
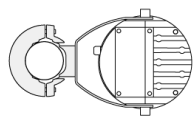

PC2 102-114/60 Pole clamp, double (Ø 102-114)	139-2707	102-114	1.20
--	----------	---------	------



Projectors

Description	Part ID	D1	Weight (kg)
PC1 114-133/60 Pole clamp, single (Ø 114-133)	139-2708	114-133	1.40

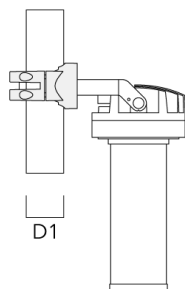
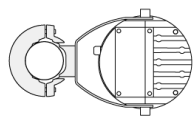

PC2 114-133/60 Pole clamp, double (Ø 114-133)	139-2709	114-133	1.40
--	----------	---------	------

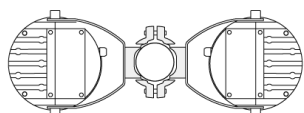

Control

R2C Ready to Connect

Description	Part ID
R2C Ready to Connect (top)	430-0019

FLC220 LED [GP]

Projectors

WE-EF LEUCHTEN GmbH

Töpinger Straße 16, 29646 Bispingen, Germany

Phone: +49 5194 909-0

info@we-ef.com

<https://we-ef.com>

Subject to technical changes and errors.

Generated on 22/10/2024