

### Beschreibung





Projektor [GP] zur Projektion von Gobos auf Flächen. Sphärisches und asphärisches, zweifaches Plankonvexlinsensystem aus Glas zur Erzeugung eines parallelen Lichtbündels. Gobo Motive auf Anfrage, Gobo muss separat bestellt werden.

IP66, SKI. IK07. Korrosionsbeständiger Aluminiumguss. PCS beschichtete Edelstahlschrauben. 5CE Korrosionsschutz. CCG® Silikondichtung. Sicherheitsglas. Eine Kabelverschraubung, eine zweite Kabelverschraubung zur Durchverdrahtung auf Anfrage. PMMA LED Linse. Eingebaute LED Platine, austauschbar. Eingebaute elektronische Betriebsgeräte, thermisch getrennt.

Gobo Außendurchmesser 66 mm, max. bedruckbare Fläche  $D = 48$  mm. WE-EF Empfehlung  $D = 38$  mm.

**Spezifikationen****Materialbeschreibung**

---

Gehäuse	Korrosionsbeständiger Aluminiumguss
Abdeckung	Sicherheitsglasscheibe
Farben	 RAL9004 Signalschwarz  RAL9006 Weißaluminium  RAL9007 Graualuminium  RAL7016 Anthrazitgrau  RAL9016 Verkehrsweiß
Dichtung	CCG® Silikondichtung
Schrauben	PCS beschichtete Edelstahlschrauben
Schutzart	IP66
Schlagfestigkeit	IK07
Korrosionsbeständigkeit	5CE
Windangriffsfläche	0.06 m <sup>2</sup>

---

**Elektrische Beschreibung**

---

Netz	220-240V / 50-60 Hz
Netzgerät / Vorschaltgerät	Standard. Variante mit DALI erhältlich, bei Bestellung bitte angeben.
Leistungsfaktor	> 0.9
Überspannungsschutz	6/6 kV (optional SP10)

---

**Weitere Informationen**

---

Lebensdauer	Ta=25° L70B50 > 50000h
Energieeffizienzklasse	F (Lichtquelle)

---

# FLC220 LED [GP]

Scheinwerfer symmetrisch

**we-ef**

## Auswahl

### Lichtverteilung



symmetrisch Gobo-Projector [GP] - min. Öffnungswinkel



symmetrisch Gobo-Projector [GP] - max. Öffnungswinkel

### Farbtemperaturen



3000 K



4000 K



2700 K

### Nominal Watt

0 W



#### WE-EF LEUCHTEN GmbH

Töpinger Straße 16, 29646 Bispingen, Germany - Tel: +49 5194 909-0

info.germany@we-ef.com - <https://we-ef.com/de>

Technische Änderungen und Irrtümer vorbehalten. - Erstellt am 23.10.2024

### Konfigurationen

Lichtverteilung	Artikelnummer	Lichtquelle	Bemes- sungslicht- strom	Bemes- sungsleis- tung	CRI	Gewicht (kg)
symmetrisch Gobo-Projector [GP] - max. Öffnungswinkel 	139-2116_max	LED-FT-37W / 1050 mA - 3000 K	1383.2	42 W	80	8.20
	139-2124_max	LED-FT-37W / 1050 mA - 4000 K	1442	42 W	80	8.20
	139-2128_max	LED-FT-24W / 700 mA - 3000 K	1019.7	27 W	80	8.20
	139-2129_max	LED-FT-24W / 700 mA - 4000 K	1063.9	27 W	80	8.20
	139-2509_max	LED-FT-24W / 700 mA - 2700 K	990.3	27 W	80	8.20
	139-2512_max	LED-FT-37W / 1050 mA - 2700 K	1343.5	42 W	80	8.20
symmetrisch Gobo-Projector [GP] - min. Öffnungswinkel 	139-2116_min	LED-FT-37W / 1050 mA - 3000 K	1339.3	42 W	80	8.20
	139-2124_min	LED-FT-37W / 1050 mA - 4000 K	1396.3	42 W	80	8.20
	139-2128_min	LED-FT-24W / 700 mA - 3000 K	987.4	27 W	80	8.20
	139-2129_min	LED-FT-24W / 700 mA - 4000 K	1030.1	27 W	80	8.20
	139-2509_min	LED-FT-24W / 700 mA - 2700 K	958.9	27 W	80	8.20
	139-2512_min	LED-FT-37W / 1050 mA - 2700 K	1300.8	42 W	80	8.20

### Montagezubehör

#### Montagesockel EM

Beschreibung	Artikelnummer	D1	D2	H1	M1	Gewicht (kg)
EM1-M16	270-9038	160	130	200	9	2

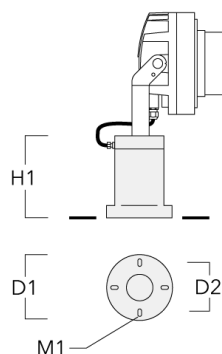

#### Mastaufsatztraverse TA

Beschreibung	Artikelnummer	A	C1	D x L1	Gewicht (kg)	D x S
TA1 Mastaufsatztraverse, einfach (Ø 108 x 200)	147-0096		130	108 x 200	7.50	108 x 200

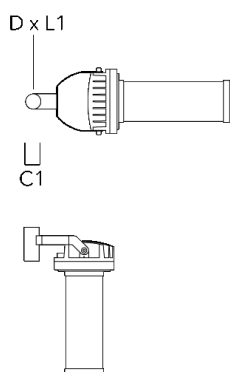

## Scheinwerfer symmetrisch

Beschreibung	Artikelnummer	A	C1	D x L1	Gewicht (kg)	D x S
TA2 Mastaufsatztraverse, zweifach (Ø 108 x 200)	147-0097		130	108 x 200	7.50	108 x 200

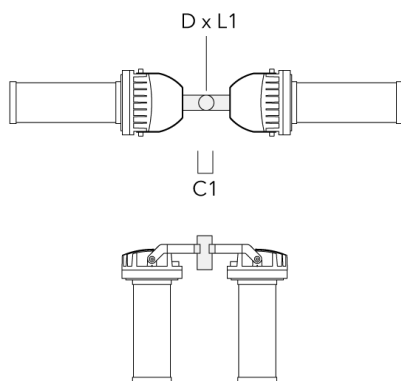

TA2-L Mastaufsatztraverse, zweifach (Ø 76 x 200)	147-0105	$\pm 90^\circ$	420	76 x 200	16.10	76 x 200
--	----------	----------------	-----	----------	-------	----------

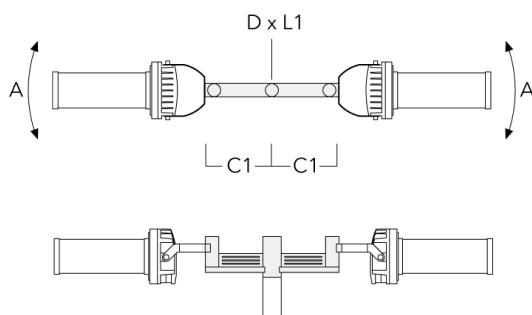

## Scheinwerfer symmetrisch

Beschreibung	Artikelnummer	A	C1	D x L1	Gewicht (kg)	D x S
TA3 Mastaufsatztraverse, dreifach (Ø 89 x 200)	147-0025	±90°	650	89 x 200	17.90	89 x 200

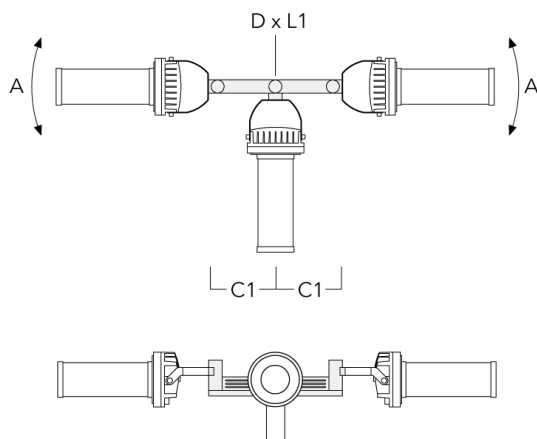

TA3 Mastaufsatztraverse, dreifach (Ø 108 x 200)	147-0098	±90°	650	108 x 200	24.20	108 x 200
---	----------	------	-----	-----------	-------	-----------

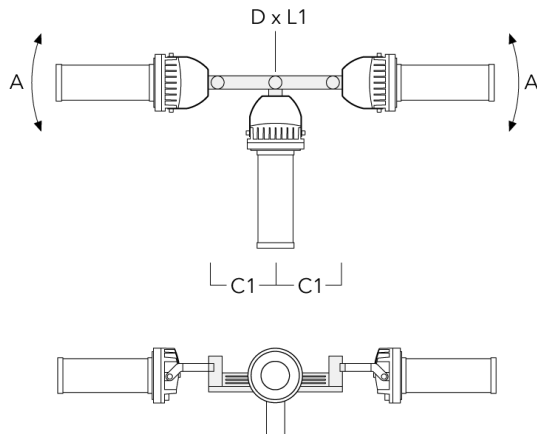

## Scheinwerfer symmetrisch

Beschreibung	Artikelnummer	A	C1	D x L1	Gewicht (kg)	D x S
TA4 Mastaufsatztraverse, vierfach (Ø 89 x 200)	147-0099	±90°	650	89 x 200	20.80	89 x 200

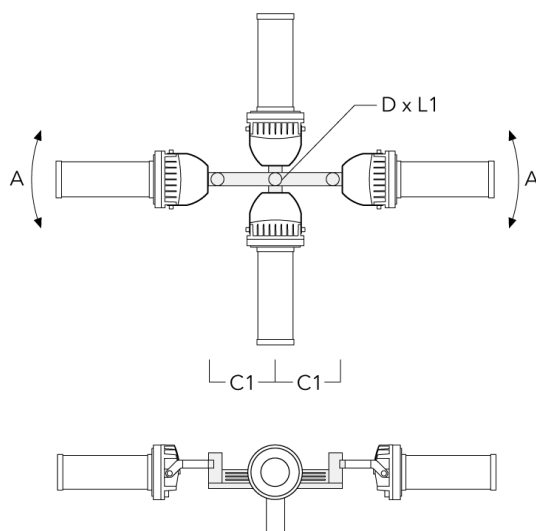

TA4 Mastaufsatztraverse, vierfach (Ø 108 x 200)	147-0100	±90°	650	108 x 200	24.20	108 x 200
---	----------	------	-----	-----------	-------	-----------

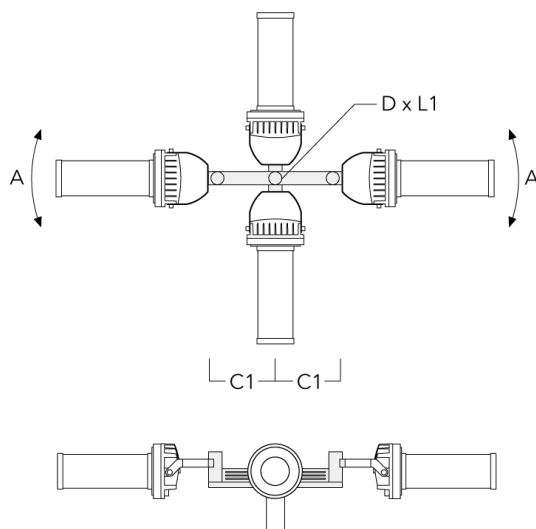

## Mastschelle TS

### WE-EF LEUCHTEN GmbH

Töpinger Straße 16, 29646 Bispingen, Germany - Tel: +49 5194 909-0

info.germany@we-ef.com - <https://we-ef.com/de>

Technische Änderungen und Irrtümer vorbehalten. - Erstellt am 23.10.2024



## Scheinwerfer symmetrisch

Beschreibung	Artikelnummer	D1	Gewicht (kg)	D
TS1-2/M12 Mastschelle, einfach (Ø 102-114)	147-0526	102-114	1.50	102-114

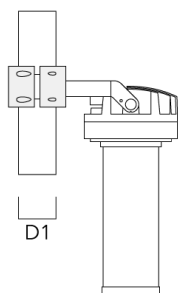
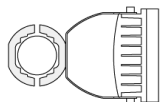

TS1-2/M12 Mastschelle, einfach (Ø 114-133)	147-0544	114-133	1.70	114-133
--	----------	---------	------	---------

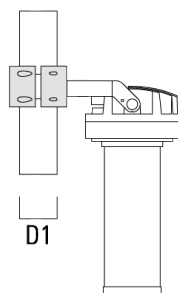
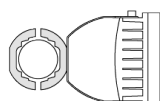

## Scheinwerfer symmetrisch

Beschreibung	Artikelnummer	D1	Gewicht (kg)	D
TS2-2/M12 Mastschelle, zweifach (Ø 102-114)	147-0527	102-114	1.50	102-114

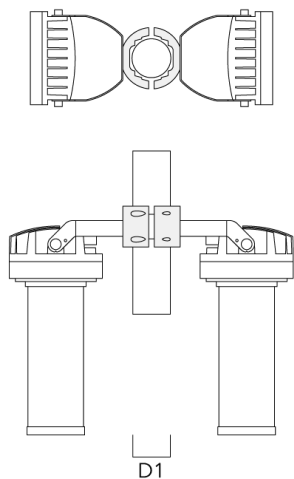

TS2-2/M12 Mastschelle, zweifach (Ø 76-89)	147-0545	76-89	1.40	76-89
---	----------	-------	------	-------

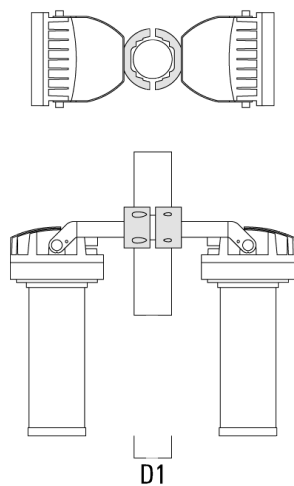

## Scheinwerfer symmetrisch

Beschreibung	Artikelnummer	D1	Gewicht (kg)	D
TS2-2/M12 Mastschelle, zweifach (Ø 114-133)	147-0546	114-133	1.60	114-133

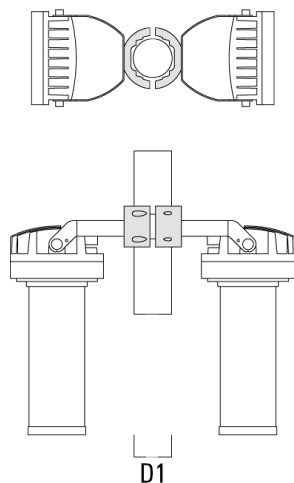

TS1-2/M12 Mastschelle, einfach (Ø 76-89)	147-0543	76-89	1.40	76-89
--	----------	-------	------	-------

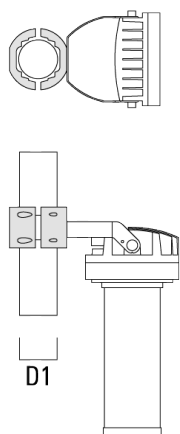

## Mastschelle PC

### WE-EF LEUCHTEN GmbH

Töpinger Straße 16, 29646 Bispingen, Germany - Tel: +49 5194 909-0

info.germany@we-ef.com - <https://we-ef.com/de>

Technische Änderungen und Irrtümer vorbehalten. - Erstellt am 23.10.2024

## Scheinwerfer symmetrisch

Beschreibung	Artikelnummer	D1	Gewicht (kg)
PC1 76-89/60 Mastschelle, einfach (Ø 76-89)	139-2702	76-89	1.00

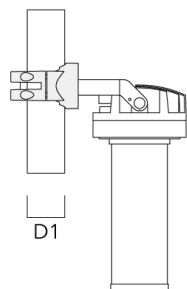
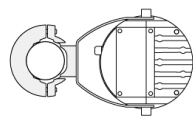

PC2 76-89/60 Mastschelle, zweifach (Ø 76-89)	139-2703	76-89	1.00
--	----------	-------	------

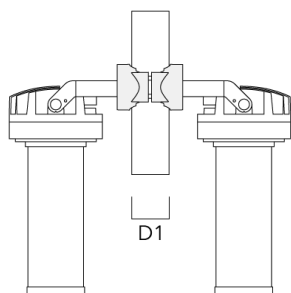
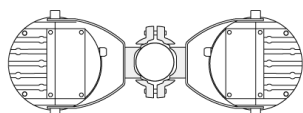

## Scheinwerfer symmetrisch

Beschreibung	Artikelnummer	D1	Gewicht (kg)
PC1 82-109/60 Mastschelle, einfach (Ø 82-109)	139-2704	82-109	1.10

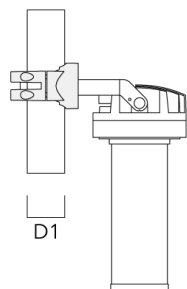
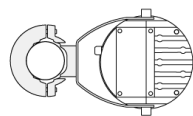

PC2 82-109/60 Mastschelle, zweifach (Ø 82-109)	139-2705	82-109	1.10
---	----------	--------	------

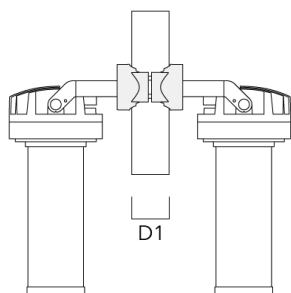
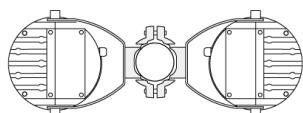

## Scheinwerfer symmetrisch

Beschreibung	Artikelnummer	D1	Gewicht (kg)
PC1 102-114/60 Mastschelle, einfach (Ø 102-114)	139-2706	102-114	1.20

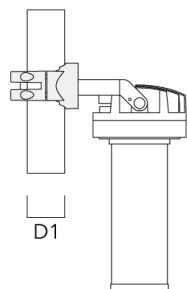
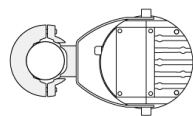

PC2 102-114/60 Mastschelle, zweifach (Ø 102-114)	139-2707	102-114	1.20
---	----------	---------	------



## Scheinwerfer symmetrisch

Beschreibung	Artikelnummer	D1	Gewicht (kg)
PC1 114-133/60 Mastschelle, einfach (Ø 144-133)	139-2708	114-133	1.40

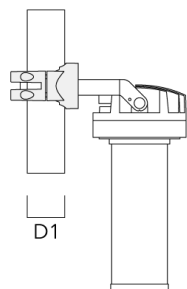
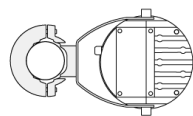

PC2 114-133/60 Mastschelle, zweifach (Ø 114-133)	139-2709	114-133	1.40
---	----------	---------	------



# FLC220 LED [GP]

Scheinwerfer symmetrisch

**we-ef**

## Steuerung

### R2C Ready to Connect

Beschreibung	Artikelnummer
R2C Ready to Connect (oben)	430-0019

#### WE-EF LEUCHTEN GmbH

Töpinger Straße 16, 29646 Bispingen, Germany - Tel: +49 5194 909-0

info.germany@we-ef.com - <https://we-ef.com/de>

Technische Änderungen und Irrtümer vorbehalten. - Erstellt am 23.10.2024



**FLC220 LED [GP]**  
**Scheinwerfer symmetrisch**

**WE-EF LEUCHTEN GmbH**

Töpinger Straße 16, 29646 Bispingen, Germany  
Tel: +49 5194 909-0

[info.germany@we-ef.com](mailto:info.germany@we-ef.com)  
<https://we-ef.com/de>

Technische Änderungen und Irrtümer vorbehalten.  
Erstellt am 23.10.2024