

LTM440 LED
Light columns

we-ef

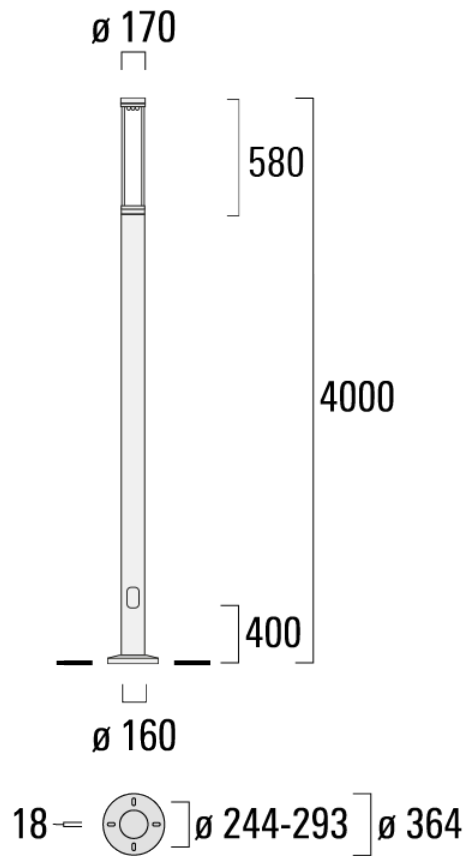

WE-EF LIGHTING (Thailand) Co., Ltd.

57 Moo 5, Kingkaew Rd., Bangplee, 10540 Samutprakarn - Phone: +66 2 738 96 20 - Fax: +66 2 738 96 29

<https://we-ef.com/asia>

Subject to technical changes and errors. - Generated on 23/11/2024

LTM440 LED

Light columns

Description





IP55, Class I, IK09. Marine-grade, all-aluminium construction. 5CE superior corrosion protection including PCS hardware. Silicone rubber gasket. Polycarbonate lens.

Integral EC electronic converter. CAD-optimised optics for superior illumination and glare control. Optional 2200 K version available. To be specified at time of ordering.

Service door with fused cable connecting box.

Supplied as a complete luminaire (luminaire head and standpipe). Please note: The standpipe height must be entered for the photometric calculation.

Specifications**Material description**

Body	Marine-grade, all-aluminium construction
Lens	PMMA
Colours	 RAL9004 Signal black  RAL9007 Grey aluminium  RAL7016 Anthracite grey  RAL9016 Traffic white
Gasket	Silicone rubber gasket
Fasteners	PCS Polymer Coated Stainless Steel Hardware
Ingress protection	IP55
Impact resistance	IK09
Corrosion resistance	5CE

Electrical description

Driver / Ballast	Integral EC electronic converter
Power factor	> 0.9

Additional information

Lifetime	Ta=25° L90B10 > 90000h
----------	------------------------

LTM440 LED

Light columns

Options

Light distribution



asymmetric, side throw [S65]



rectangular, side throw [R65]

Colour temperature



3000 K



4000 K



2700 K

Nominal Watt

0 W

Configurations

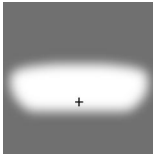
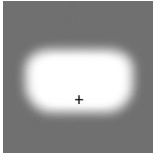
Light distribution	Part ID	Light source	Rated lumens	Rated input power	CRI	Weight (kg)
asymmetric, side throw [S65] 	115-1525	LED-9/18W / 700 mA - 3000 K	2320.1	20 W	80	25.00
	115-1526	LED-9/18W / 700 mA - 4000 K	2480.1	20 W	80	25.00
	115-1569	LED-9/27W / 1050 mA - 3000 K	3440.2	30 W	80	25.00
	115-1570	LED-9/27W / 1050 mA - 4000 K	3600.2	30 W	80	25.00
	115-1782	LED-9/18W / 700 mA - 2700 K	2160.1	20 W	80	25.00
	115-1783	LED-9/27W / 1050 mA - 2700 K	3280.1	30 W	80	25.00
rectangular, side throw [R65] 	115-1527	LED-9/18W / 700 mA - 3000 K	2448.9	20 W	80	25.00
	115-1528	LED-9/18W / 700 mA - 4000 K	2617.8	20 W	80	25.00
	115-1567	LED-9/27W / 1050 mA - 3000 K	3631.1	30 W	80	25.00
	115-1568	LED-9/27W / 1050 mA - 4000 K	3800	30 W	80	25.00
	115-1784	LED-9/18W / 700 mA - 2700 K	2280	20 W	80	25.00
	115-1785	LED-9/27W / 1050 mA - 2700 K	3462.2	30 W	80	25.00

Mounting Accessories

Planted root

Description	Part ID	D1	D2	D3	D4	H1	H2	M1	T1	T2	Weight (kg)
Planted root ESV6	300-0457-AP	305	270	106	140	606	506	16	200	50 x 100	18.10

