

139-1965

FLC260-CC LED

we-ef



Description

Changement de couleurs RGBW. IP66. Classe I. Classe II sur demande. IK07. Corps en fonte d'aluminium. Visserie inox avec traitement PCS. Protection contre la corrosion 5CE. Joint silicone CCG®. Verre de sécurité. LED contrôlables par système DMX.

Technologie sans fil DMX Wireless disponible.

Poids	18.00 kg
Distribution de la lumière	faisceau symétrique, extensif [B]
Source lumineuse	LED-36/144W - RGBW/4K
IRC	20/80
Alimentation électrique	ballast électronique
LEDs	36
Rated input power	150 W

Flux lumineux nominal (lm)

LED Lumen	340
Total Lumen	12240
Tj	85

Rated lumens (lm)

LED Lumen	248.6
Total Lumen	8949.1
Ta	25

WE-EF Switzerland AG

Himmelrichstrasse 6, 6003 Luzern - Téléphone: +41 22 752 49 94

info.switzerland@we-ef.com - https://we-ef.com/ch_fr

Sous réserve de modifications techniques et d'erreurs. - Généré le 10/03/2025

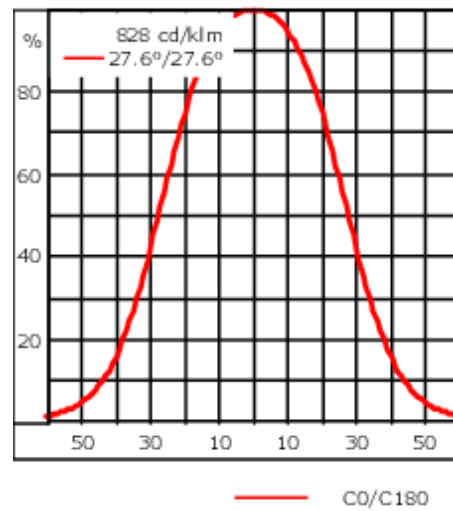
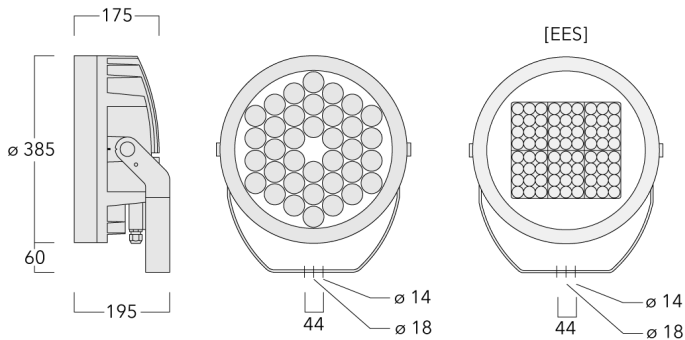

Spécifications

Description du matériel

Corps	Corps en fonte d'aluminium
Lentille	Verre de sécurité
Couleurs	<div style="display: flex; align-items: center; gap: 10px;"> <div style="width: 20px; height: 15px; background-color: black; margin-right: 5px;"></div> RAL9004 Noir de sécurité </div> <div style="display: flex; align-items: center; gap: 10px; margin-top: 5px;"> <div style="width: 20px; height: 15px; background-color: #808080; margin-right: 5px;"></div> RAL9007 Aluminium gris </div> <div style="display: flex; align-items: center; gap: 10px; margin-top: 5px;"> <div style="width: 20px; height: 15px; background-color: #333333; margin-right: 5px;"></div> RAL7016 Gris anthracite </div> <div style="display: flex; align-items: center; gap: 10px; margin-top: 5px;"> <div style="width: 20px; height: 15px; background-color: #e0e0e0; margin-right: 5px;"></div> RAL9016 Blanc signalisation </div>
Joint	Joint silicone CCG®
Visserie	PCS Polymer Coated Stainless Steel Hardware
IP	IP66
IK	IK07
Protection contre la corrosion	5CE
Surface exposée au vent	0.116 m ²

Description électrique

Alimentation électrique	220-240V / 50-60 Hz
Driver	DMX
Power factor	> 0.9

WE-EF Switzerland AG

Himmelrichstrasse 6, 6003 Luzern - Téléphone: +41 22 752 49 94

info.switzerland@we-ef.com - https://we-ef.com/ch_fr

Sous réserve de modifications techniques et d'erreurs. - Généré le 10/03/2025

139-1965

FLC260-CC LED

we-ef

Informations complémentaires

Durée de vie Ta=25° L90B10 > 90000h

Classe d'efficacité
énergétique G

WE-EF Switzerland AG

Himmelrichstrasse 6, 6003 Luzern - Téléphone: +41 22 752 49 94

info.switzerland@we-ef.com - https://we-ef.com/ch_fr

Sous réserve de modifications techniques et d'erreurs. - Généré le 10/03/2025

Accessoires Optiques

Lentille élargissante

Description	Référence	C1
IO-360-FLC260-LED	139-1862	332

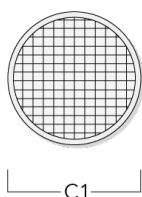

Grille nid d'abeille

Description	Référence	C1	H1
IW-03-FLC260-LED - [E][EE][EES]	139-1863	324	

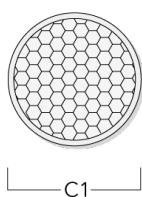

Description	Référence	C1	H1
IW-FLC26_EES-CC LED	139-2434	232	209

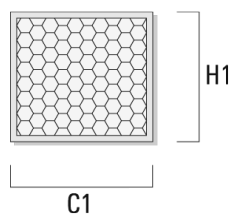

Lentille ovalisante

Description	Référence	C1
IO-180-FLC260-CC LED	139-1861	332

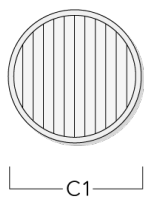

Lentille rasante

Description	Référence	C1
IO-20-FLC260-CC LED	139-1860	332

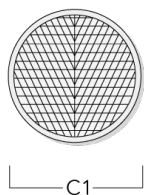
**Canon anti-éblouissement**

Description	Référence	A	C1
ET-FLC260-LED	139-1865	222	393

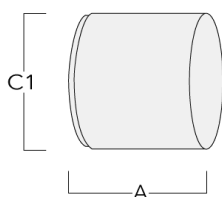

Visière

Description	Référence	A	C1
ES-FLC260-LED	139-1864	222	393

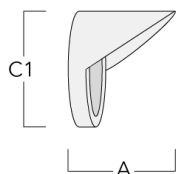

Accessoires d'installation

Collier pour mâts TS

Description	Référence	D1	Poids (kg)	D
TS1-2/M12 collier simple pour tube (Ø 76-89)	147-0543	76-89	1.40	76-89

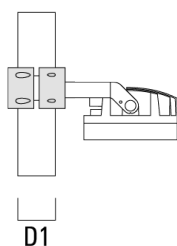
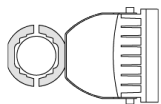

TS1-2/M12 collier simple pour tube (Ø 114-133)	147-0544	114-133	1.70	114-133
---	----------	---------	------	---------

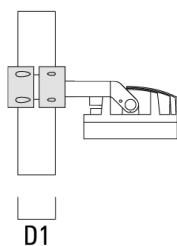
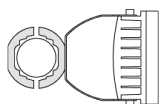

FLC260-CC LED

Description	Référence	D1	Poids (kg)	D
TS2-2/M12 collier double pour tube (Ø 76-89)	147-0545	76-89	1.40	76-89

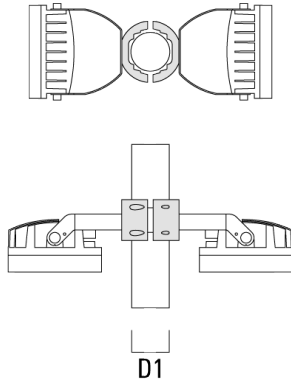

TS2-2/M12 collier double pour tube (Ø 114-133)	147-0546	114-133	1.60	114-133
---	----------	---------	------	---------

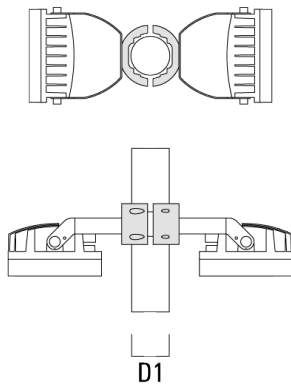

Traverse pour mâts

Description	Référence	C1	D x L1	Poids (kg)	D x S
TA1 traverse simple (Ø 76 x 200)	147-0023	130	76 x 200	1.90	76 x 200

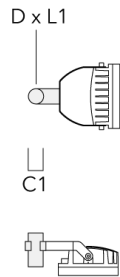
**Collier pour mâts PC**

Description	Référence	D1	Poids (kg)
PC2 76-89/60 collier double pour tube (Ø 76-89)	139-2703	76-89	1.00

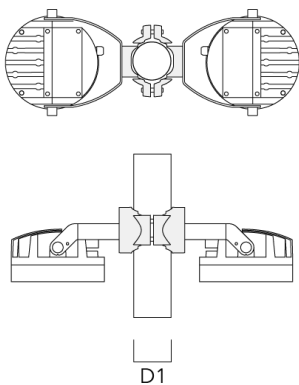

FLC260-CC LED

Description	Référence	D1	Poids (kg)
PC1 76-89/60 collier simple (Ø 76-89)	139-2702	76-89	1.00

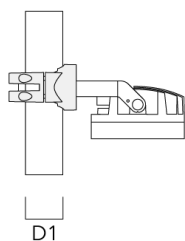
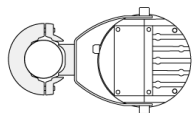

PC2 102-114/60 collier double pour tube (Ø 102-114)	139-2707	102-114	1.20
---	----------	---------	------

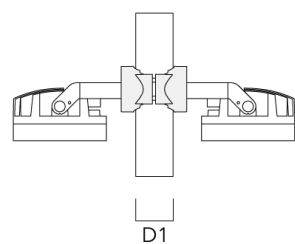
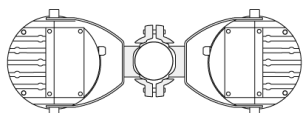

Description	Référence	D1	Poids (kg)
PC1 102-114/60 collier simple (Ø 102-114)	139-2706	102-114	1.20

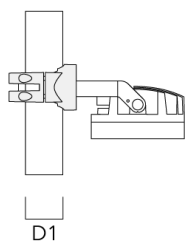
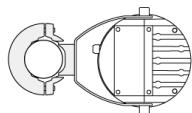

PC2 114-133/60 collier double pour tube (Ø 114-133)	139-2709	114-133	1.40
---	----------	---------	------

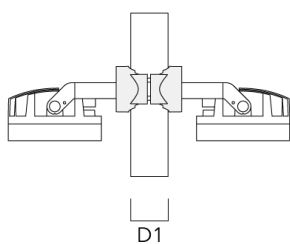
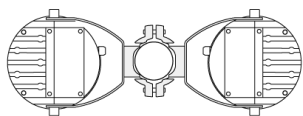

Description	Référence	D1	Poids (kg)
PC1 114-133/60 collier simple (Ø 114-133)	139-2708	114-133	1.40

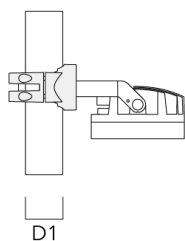
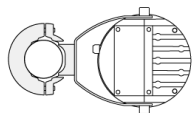

PC2 82-109/60 collier double pour tube (Ø 82-109)	139-2705	82-109	1.10
---	----------	--------	------

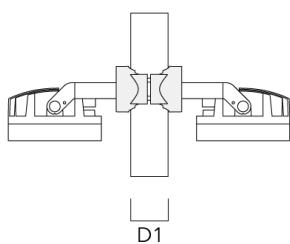
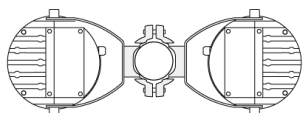

Description	Référence	D1	Poids (kg)
PC1 82-109/60 collier simple (Ø 82-109)	139-2704	82-109	1.10

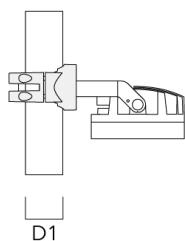
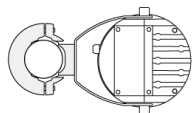

Control

DMX Controller

Description	Référence
DMX Controller	400-0469

DMX Controller (smart)

Description	Référence	Informations complémentaires
DMX Controller (smart)	400-0470	IP20. The Touch Panel is an intuitive and easy-to-use keypad for one DMX universe. It can store up to 36 scenes; alternatively, via



DMX Controller - RDM ready

Description	Référence
DMX Controller - RDM ready	400-0471

**DMX Splitter**

Description	Référence
DMX Splitter	400-0473

**WE-EF Switzerland AG**

Himmelrichstrasse 6, 6003 Luzern - Téléphone: +41 22 752 49 94

info.switzerland@we-ef.com - https://we-ef.com/ch_fr

Sous réserve de modifications techniques et d'erreurs. - Généré le 10/03/2025

DMX Booster Box

Description	Référence
DMX Booster Box	400-0474

**DMX Motion Sensor**

Description	Référence
DMX Motion Sensor	400-0478



DMX Termination Plug

Description	Référence
DMX Termination Plug	400-0475

**DMX Plug and Socket**

Description	Référence
DMX Plug and Socket	400-0479



DMX Combination Cable

Description	Référence
DMX Combination Cable	400-0480

**DMX Wireless Repeater**

Description	Référence
DMX Wireless Repeater	400-0477



DMX Wireless Transceiver

Description	Référence
DMX Wireless Transceiver	400-0476

**DMX Controller (smart) - RDM ready**

Description	Référence
DMX Controller (smart) - RDM ready	400-0472

**DMX Wireless Antenna**

Description	Référence
Antenne RF 5dB	430-0036

WE-EF Switzerland AG

Himmelrichstrasse 6, 6003 Luzern - Téléphone: +41 22 752 49 94

info.switzerland@we-ef.com - https://we-ef.com/ch_fr

Sous réserve de modifications techniques et d'erreurs. - Généré le 10/03/2025

139-1965

FLC260-CC LED

we-ef

Description	Référence
Antenne RF1.8 dB	430-0018

WE-EF Switzerland AG

Himmelrichstrasse 6, 6003 Luzern - Téléphone: +41 22 752 49 94

info.switzerland@we-ef.com - https://we-ef.com/ch_fr

Sous réserve de modifications techniques et d'erreurs. - Généré le 10/03/2025