



Beschreibung

RGBW/RGBA Farbwechsler. IP66, SKI. SKII auf Anfrage. IK07. Korrosionsbeständiger Aluminiumguss. PCS beschichtete Edelstahlschrauben. 5CE Korrosionsschutz. CCG® Controlled Compression Gasket Silikondichtung. Sicherheitsglas. Eine Kabelverschraubung, eine zweite Kabelverschraubung zur Durchverdrahtung als Variante erhältlich. Eingebaute elektronische Betriebsgeräte, thermisch getrennt. CAD-optimierte OLC® One LED Concept Technik zur Lichtlenkung und Entblendung. Eingebaute LED Platine. DMX Schnittstelle. M20 Kabelverschraubung für Netz- und DMX-Kabel vorgesehen, WE-EF empfiehlt ein Kombikabel für DMX & Power "Power PUR-SR 3x1,5 + DMX".

| | |
|--------------------|-----------------------------|
| Gewicht | 7.70 kg |
| Lichtverteilung | bandförmig engstrahlend [E] |
| Lichtquelle | LED-12/48W - RGBW/4K |
| CRI | 20/80 |
| Netz | EVG |
| LEDs | 12 |
| Bemessungsleistung | 50 W |

Nominal Lichtstrom (lm)

| | |
|-------------|------|
| LED Lumen | 340 |
| Total Lumen | 4080 |
| Tj | 85 |

Bemessungslichtstrom (lm)

| | |
|-------------|--------|
| LED Lumen | 238.8 |
| Total Lumen | 2865.3 |
| Ta | 25 |

WE-EF Switzerland AG

Himmelrichstrasse 6, 6003 Luzern - Tel: +41 41 210 49 95

info.switzerland@we-ef.com - https://we-ef.com/ch_de

Technische Änderungen und Irrtümer vorbehalten. - Erstellt am 10.03.2025

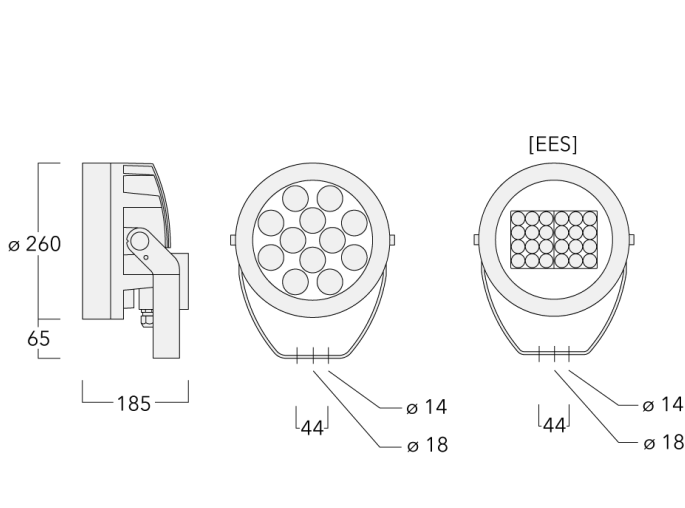

Spezifikationen

Materialbeschreibung

| | |
|-------------------------|---|
| Gehäuse | Korrosionsbeständiger Aluminiumguss |
| Abdeckung | Sicherheitsglasscheibe |
| Farben | <div style="display: flex; align-items: center;"> <div style="width: 20px; height: 15px; background-color: black; margin-right: 5px;"></div> RAL9004 Signalschwarz </div> <div style="display: flex; align-items: center; margin-top: 5px;"> <div style="width: 20px; height: 15px; background-color: gray; margin-right: 5px;"></div> RAL9007 Graualuminium </div> <div style="display: flex; align-items: center; margin-top: 5px;"> <div style="width: 20px; height: 15px; background-color: darkgray; margin-right: 5px;"></div> RAL7016 Anthrazitgrau </div> <div style="display: flex; align-items: center; margin-top: 5px;"> <div style="width: 20px; height: 15px; background-color: lightgray; margin-right: 5px;"></div> RAL9016 Verkehrsweiß </div> |
| Dichtung | CCG® Silikondichtung |
| Schrauben | PCS beschichtete Edelstahlschrauben |
| Schutzart | IP66 |
| Schlagfestigkeit | IK07 |
| Korrosionsbeständigkeit | 5CE |
| Windangriffsfläche | 0.054 m ² |

Elektrische Beschreibung

| | |
|-------------------------------|------------------------|
| Netz | 220-240V / 50-60 Hz |
| Netzgerät / Vorschaltgerät | DMX |
| Leistungsfaktor | > 0.9 |
| Überspannungsschutz | 1/2 kV (optional SP10) |

WE-EF Switzerland AG

Himmelrichstrasse 6, 6003 Luzern - Tel: +41 41 210 49 95
 info.switzerland@we-ef.com - https://we-ef.com/ch_de
 Technische Änderungen und Irrtümer vorbehalten. - Erstellt am 10.03.2025

139-1914+139-1849

FLC230-CC LED

we-ef

Weitere Informationen

Lebensdauer Ta=25° L90B10 > 90000h

Energieeffizienzklasse G (Lichtquelle)

WE-EF Switzerland AG

Himmelrichstrasse 6, 6003 Luzern - Tel: +41 41 210 49 95

info.switzerland@we-ef.com - https://we-ef.com/ch_de

Technische Änderungen und Irrtümer vorbehalten. - Erstellt am 10.03.2025

FLC230-CC LED

Steuerung

Eco Step Dim® Basic

| Beschreibung | Artikelnummer |
|-------------------------|---------------|
| Eco Step Dim® Basic LED | 430-0001 |

Eco Step Dim® Advanced

| Beschreibung | Artikelnummer |
|----------------------------|---------------|
| Eco Step Dim® Advanced LED | 430-0002 |

DMX Controller

| Beschreibung | Artikelnummer |
|----------------|---------------|
| DMX Controller | 400-0469 |

DMX Controller (smart)

| Beschreibung | Artikelnummer | Weitere Informationen |
|------------------------|---------------|---|
| DMX Controller (smart) | 400-0470 | IP20. The Touch Panel is an intuitive and easy-to use keypad or one DMX universe. It can store up to 36 scenes; alternatively, via |



FLC230-CC LED

DMX Controller - RDM ready

| Beschreibung | Artikelnummer |
|----------------------------|---------------|
| DMX Controller - RDM ready | 400-0471 |



DMX Splitter

| Beschreibung | Artikelnummer |
|--------------|---------------|
| DMX Splitter | 400-0473 |



WE-EF Switzerland AG

Himmelrichstrasse 6, 6003 Luzern - Tel: +41 41 210 49 95

info.switzerland@we-ef.com - https://we-ef.com/ch_de

Technische Änderungen und Irrtümer vorbehalten. - Erstellt am 10.03.2025

FLC230-CC LED

DMX Booster Box

| Beschreibung | Artikelnummer |
|-----------------|---------------|
| DMX Booster Box | 400-0474 |



DMX Motion Sensor

| Beschreibung | Artikelnummer |
|-------------------|---------------|
| DMX Motion Sensor | 400-0478 |



WE-EF Switzerland AG

Himmelrichstrasse 6, 6003 Luzern - Tel: +41 41 210 49 95

info.switzerland@we-ef.com - https://we-ef.com/ch_de

Technische Änderungen und Irrtümer vorbehalten. - Erstellt am 10.03.2025

FLC230-CC LED

DMX Termination Plug

| Beschreibung | Artikelnummer |
|----------------------|---------------|
| DMX Termination Plug | 400-0475 |



DMX Plug and Socket

| Beschreibung | Artikelnummer |
|---------------------|---------------|
| DMX Plug and Socket | 400-0479 |



FLC230-CC LED

DMX Combination Cable

| Beschreibung | Artikelnummer |
|-----------------------|---------------|
| DMX Combination Cable | 400-0480 |



DMX Wireless Repeater

| Beschreibung | Artikelnummer |
|-----------------------|---------------|
| DMX Wireless Repeater | 400-0477 |



FLC230-CC LED

DMX Wireless Transceiver

| Beschreibung | Artikelnummer |
|--------------------------|---------------|
| DMX Wireless Transceiver | 400-0476 |



DMX Controller (smart) - RDM ready

| Beschreibung | Artikelnummer |
|------------------------------------|---------------|
| DMX Controller (smart) - RDM ready | 400-0472 |



R2C Ready to Connect

| Beschreibung | Artikelnummer |
|-----------------------------|---------------|
| R2C Ready to Connect (oben) | 430-0019 |

WE-EF Switzerland AG

Himmelrichstrasse 6, 6003 Luzern - Tel: +41 41 210 49 95
 info.switzerland@we-ef.com - https://we-ef.com/ch_de
 Technische Änderungen und Irrtümer vorbehalten. - Erstellt am 10.03.2025

DMX Wireless Antenna

| Beschreibung | Artikelnummer |
|------------------|---------------|
| Antenne RF 5dB | 430-0036 |
| Antenne RF1.8 dB | 430-0018 |

Montagezubehör

Mastaufsatztraverse TA

| Beschreibung | Artikelnummer | A | C1 | D × L1 | Gewicht (kg) | D × S |
|--|---------------|---|-----|-----------|--------------|-----------|
| TA1 Mastaufsatztraverse, einfach (Ø 108 x 200) | 147-0096 | | 130 | 108 x 200 | 7.50 | 108 x 200 |

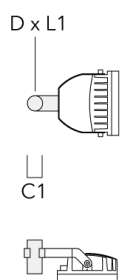

| | | | | | | |
|---|----------|--|-----|-----------|------|-----------|
| TA2 Mastaufsatztraverse, zweifach (Ø 108 x 200) | 147-0097 | | 130 | 108 x 200 | 7.50 | 108 x 200 |
|---|----------|--|-----|-----------|------|-----------|

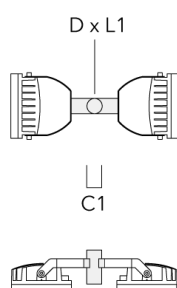

FLC230-CC LED

| Beschreibung | Artikelnummer | A | C1 | D x L1 | Gewicht (kg) | D x S |
|--|---------------|------|-----|-----------|--------------|-----------|
| TA2-L Mastaufsatztraverse, zweifach (Ø 108 x 200) | 147-0148 | ±90° | 420 | 108 x 200 | 20.20 | 108 x 200 |

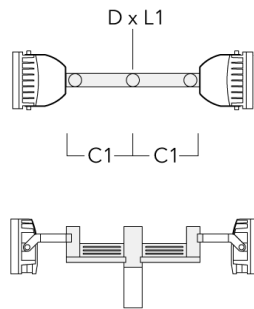

| | | | | | | |
|---|----------|------|-----|----------|-------|----------|
| TA2-L Mastaufsatztraverse, zweifach (Ø 76 x 200) | 147-0105 | ±90° | 420 | 76 x 200 | 16.10 | 76 x 200 |
|---|----------|------|-----|----------|-------|----------|

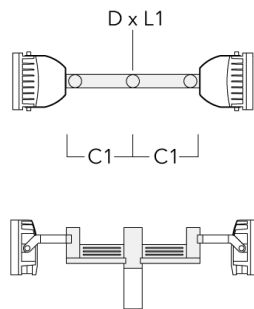

FLC230-CC LED

| Beschreibung | Artikelnummer | A | C1 | D x L1 | Gewicht (kg) | D x S |
|--|---------------|------|-----|----------|--------------|----------|
| TA3 Mastaufsatztraverse, dreifach (Ø 89 x 200) | 147-0025 | ±90° | 650 | 89 x 200 | 17.90 | 89 x 200 |



| | | | | | | |
|---|----------|------|-----|-----------|-------|-----------|
| TA3 Mastaufsatztraverse, dreifach (Ø 108 x 200) | 147-0098 | ±90° | 650 | 108 x 200 | 24.20 | 108 x 200 |
|---|----------|------|-----|-----------|-------|-----------|



FLC230-CC LED

| Beschreibung | Artikelnummer | A | C1 | D x L1 | Gewicht (kg) | D x S |
|--|---------------|------|-----|----------|--------------|----------|
| TA4 Mastaufsatztraverse, vierfach (Ø 89 x 200) | 147-0099 | ±90° | 650 | 89 x 200 | 20.80 | 89 x 200 |



| | | | | | | |
|---|----------|------|-----|-----------|-------|-----------|
| TA4 Mastaufsatztraverse, vierfach (Ø 108 x 200) | 147-0100 | ±90° | 650 | 108 x 200 | 24.20 | 108 x 200 |
|---|----------|------|-----|-----------|-------|-----------|

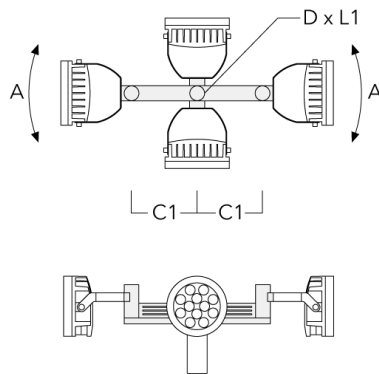

FLC230-CC LED

| Beschreibung | Artikelnummer | A | C1 | D × L1 | Gewicht (kg) | D × S |
|--|---------------|---|-----|----------|--------------|----------|
| TA2 Mastaufsatztraverse, zweifach (Ø 76 x 200) | 147-0024 | | 130 | 76 x 200 | 1.90 | 76 x 200 |

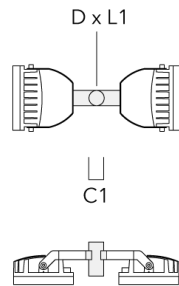

| | | | | | | |
|--|----------|--|-----|----------|------|----------|
| TA1 Mastaufsatztraverse, einfach* (Ø 76 x 200) | 147-0023 | | 130 | 76 x 200 | 1.50 | 76 x 200 |
|--|----------|--|-----|----------|------|----------|

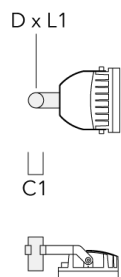

FLC230-CC LED

Mastschelle TS

| Beschreibung | Artikelnummer | D1 | Gewicht (kg) | D |
|--|---------------|---------|--------------|---------|
| TS1-2/M12 Mastschelle, einfach (Ø 102-114) | 147-0526 | 102-114 | 1.50 | 102-114 |

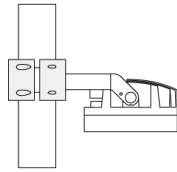
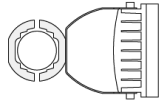

D1

| | | | | |
|--|----------|---------|------|---------|
| TS1-2/M12 Mastschelle, einfach (Ø 114-133) | 147-0544 | 114-133 | 1.70 | 114-133 |
|--|----------|---------|------|---------|

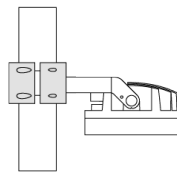
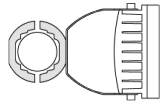

D1

FLC230-CC LED

| Beschreibung | Artikelnummer | D1 | Gewicht (kg) | D |
|--|---------------|-------|--------------|-------|
| TS1-2/M12 Mastschelle, einfach (Ø 76-89) | 147-0543 | 76-89 | 1.40 | 76-89 |

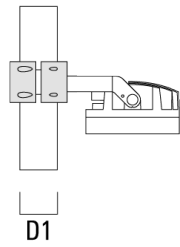

| | | | | |
|---|----------|-------|------|-------|
| TS2-2/M12 Mastschelle, zweifach (Ø 76-89) | 147-0545 | 76-89 | 1.40 | 76-89 |
|---|----------|-------|------|-------|

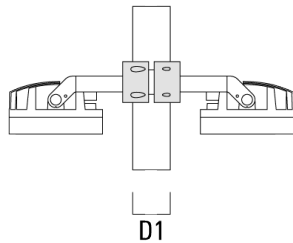
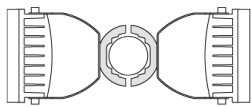

FLC230-CC LED

| Beschreibung | Artikelnummer | D1 | Gewicht (kg) | D |
|---|---------------|---------|--------------|---------|
| TS2-2/M12 Mastschelle, zweifach (Ø 114-133) | 147-0546 | 114-133 | 1.60 | 114-133 |



| | | | | |
|---|----------|---------|------|---------|
| TS2-2/M12 Mastschelle, zweifach (Ø 102-114) | 147-0527 | 102-114 | 1.50 | 102-114 |
|---|----------|---------|------|---------|

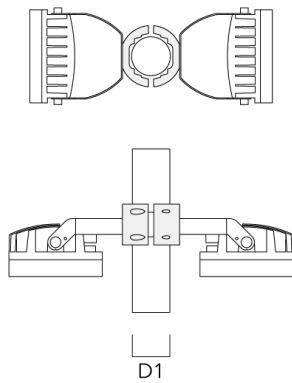

FLC230-CC LED

Erdstück

| Beschreibung | Artikelnummer | D1 | D2 | D3 | D4 | H1 | H2 | M1 | Gewicht (kg) |
|---------------|---------------|-----|-----|-----|-----|-----|-----|----|--------------|
| Erdstück ESV4 | 300-0461 | 145 | 130 | 102 | 108 | 400 | 350 | 8 | 7.05 |

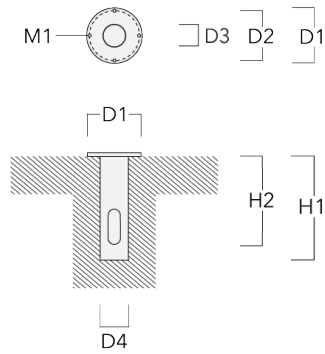

Mastschelle PC

| Beschreibung | Artikelnummer | D1 | Gewicht (kg) |
|---|---------------|-------|--------------|
| PC2 76-89/60 Mastschelle, zweifach (Ø 76-89) | 139-2703 | 76-89 | 1.00 |

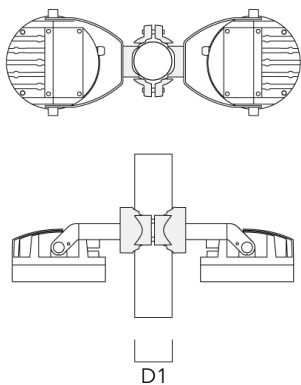

FLC230-CC LED

| Beschreibung | Artikelnummer | D1 | Gewicht (kg) |
|---|---------------|-------|--------------|
| PC1 76-89/60 Mastschelle, einfach (Ø 76-89) | 139-2702 | 76-89 | 1.00 |

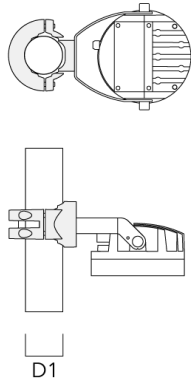

| | | | |
|--|----------|---------|------|
| PC2 102-114/60 Mastschelle, zweifach (Ø 102-114) | 139-2707 | 102-114 | 1.20 |
|--|----------|---------|------|

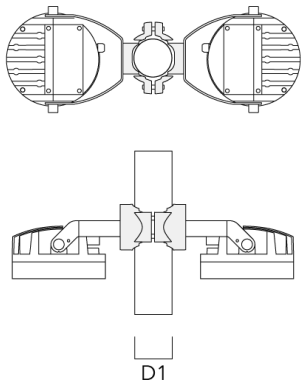

FLC230-CC LED

| Beschreibung | Artikelnummer | D1 | Gewicht (kg) |
|--|---------------|---------|--------------|
| PC1 102-114/60 Mastschelle, einfach (Ø 102-114) | 139-2706 | 102-114 | 1.20 |

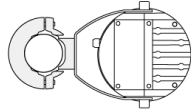

| | | | |
|---|----------|---------|------|
| PC2 114-133/60 Mastschelle, zweifach (Ø 114-133) | 139-2709 | 114-133 | 1.40 |
|---|----------|---------|------|



FLC230-CC LED

| Beschreibung | Artikelnummer | D1 | Gewicht (kg) |
|--|---------------|---------|--------------|
| PC1 114-133/60 Mastschelle, einfach (Ø 114-133) | 139-2708 | 114-133 | 1.40 |

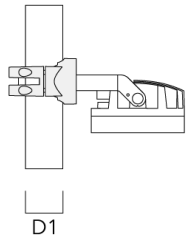
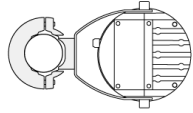

| | | | |
|---|----------|--------|------|
| PC2 82-109/60 Mastschelle, zweifach (Ø 82-109) | 139-2705 | 82-109 | 1.10 |
|---|----------|--------|------|

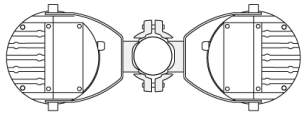

FLC230-CC LED

| Beschreibung | Artikelnummer | D1 | Gewicht (kg) |
|--|---------------|--------|--------------|
| PC1 82-109/60 Mastschelle, einfach (Ø 82-109) | 139-2704 | 82-109 | 1.10 |

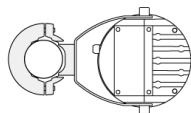

Optisches Zubehör**Seitenblende**

| Beschreibung | Artikelnummer | A | C1 |
|-----------------|---------------|-----|-----|
| Seitenblende ES | 139-1852 | 159 | 266 |

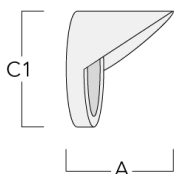
**Abblendtubus**

| Beschreibung | Artikelnummer | A | C1 |
|-----------------|---------------|-----|-----|
| Abblendtubus ET | 139-1853 | 160 | 266 |

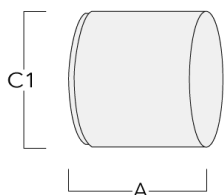

FLC230-CC LED

Streulinse bandförmig

| Beschreibung | Artikelnummer | C1 |
|-------------------|---------------|-----|
| IO-180-FLC230-LED | 139-1849 | 199 |

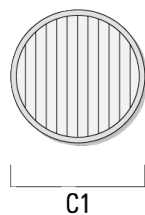

Streulinse allseitig

| Beschreibung | Artikelnummer | C1 |
|-------------------|---------------|-----|
| IO-360-FLC230-LED | 139-1850 | 199 |

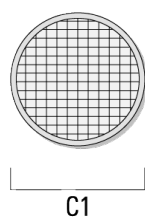

139-1914+139-1849

FLC230-CC LED

we-ef

Wallwash Linse

| Beschreibung | Artikelnummer | C1 |
|------------------|---------------|-----|
| IO-20-FLC230-LED | 139-1848 | 199 |

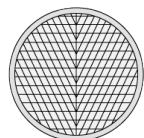

C1

WE-EF Switzerland AG

Himmelrichstrasse 6, 6003 Luzern - Tel: +41 41 210 49 95

info.switzerland@we-ef.com - https://we-ef.com/ch_de

Technische Änderungen und Irrtümer vorbehalten. - Erstellt am 10.03.2025