



Description

RGBW/RGBA Colour Changer. IP66, Class I. Class II on request. IK07. Marine-grade, die-cast aluminium alloy. 5CE superior corrosion protection including PCS hardware. Silicone CCG® Controlled Compression Gasket. Safety glass lens. One cable gland. Second gland for through-wiring on request. Integral EC electronic converter, thermally separated. CAD-optimised optics for superior illumination and glare control. OLC® One LED Concept. Factory installed LED circuit board. DMX interface. M20 cable gland for network- and DMX-connection, WE-EF recommend a multi core cable for DMX & Power "Power PUR-SR 3x1,5 + DMX".

Weight	7.70 kg
Light distribution	wallwash
Light source	LED-12/48W - RGBW/4K
CRI	20/80
Power supply	EC
LEDs	12
Rated input power	50 W
Nominal Lumen (lm)	
LED Lumen	340
Total Lumen	4080
Tj	85
Rated lumens (lm)	
LED Lumen	216.6
Total Lumen	2599.1
Ta	25

FLC230-CC LED

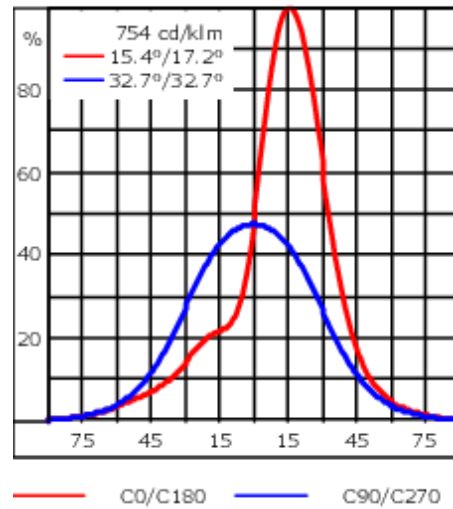
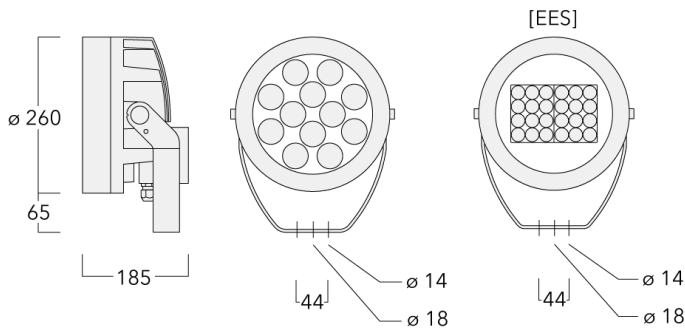

Specifications

Material description

Body	Marine-grade, die-cast aluminium alloy
Lens	Safety glass lens
Colours	<ul style="list-style-type: none"> RAL9004 Signal black RAL9006 White aluminium RAL9007 Grey aluminium RAL7016 Anthracite grey RAL9016 Traffic white
Gasket	Silicone CCG® Controlled Compression Gasket
Fasteners	PCS Polymer Coated Stainless Steel Hardware
Ingress protection	IP66
Impact resistance	IK07
Corrosion resistance	5CE
Windage	0.054 m ²

Electrical description

Power supply	220-240V / 50-60 Hz
Driver / Ballast	DMX
Power factor	> 0.9
Surge protection	1/2 kV (optional SP10)

139-1913+139-1848

FLC230-CC LED

we-ef

Additional information

Lifetime Ta=25° L90B10 > 90000h

Energy efficiency class G (Light source)

Fagerhult Lighting Ltd

33-34 Dolben Street, SE1 0UQ London, United Kingdom

<https://we-ef.com/uk>

Subject to technical changes and errors. - Generated on 10/03/2025

FLC230-CC LED

Control**Eco Step Dim® Basic**

Description	Part ID
Eco Step Dim® Basic LED	430-0001

Eco Step Dim® Advanced

Description	Part ID
Eco Step Dim® Advanced LED	430-0002

DMX Controller

Description	Part ID
DMX Controller	400-0469

DMX Controller (smart)

Description	Part ID	Additional information
DMX Controller (smart)	400-0470	IP20. The Touch Panel is an intuitive and easy-to-use keypad or one DMX universe. It can store up to 36 scenes; alternatively, via



FLC230-CC LED

DMX Controller - RDM ready

Description	Part ID
DMX Controller - RDM ready	400-0471



DMX Splitter

Description	Part ID
DMX Splitter	400-0473



FLC230-CC LED

DMX Booster Box

Description	Part ID
DMX Booster Box	400-0474



DMX Motion Sensor

Description	Part ID
DMX Motion Sensor	400-0478



FLC230-CC LED

DMX Termination Plug

Description	Part ID
DMX Termination Plug	400-0475



DMX Plug and Socket

Description	Part ID
DMX Plug and Socket	400-0479



139-1913+139-1848

we-ef

FLC230-CC LED

DMX Combination Cable

Description	Part ID
DMX Combination Cable	400-0480



DMX Wireless Repeater

Description	Part ID
DMX Wireless Repeater	400-0477



Fagerhult Lighting Ltd

33-34 Dolben Street, SE1 0UQ London, United Kingdom

<https://we-ef.com/uk>

Subject to technical changes and errors. - Generated on 10/03/2025

FLC230-CC LED

DMX Wireless Transceiver

Description	Part ID
DMX Wireless Transceiver	400-0476



DMX Controller (smart) - RDM ready

Description	Part ID
DMX Controller (smart) - RDM ready	400-0472

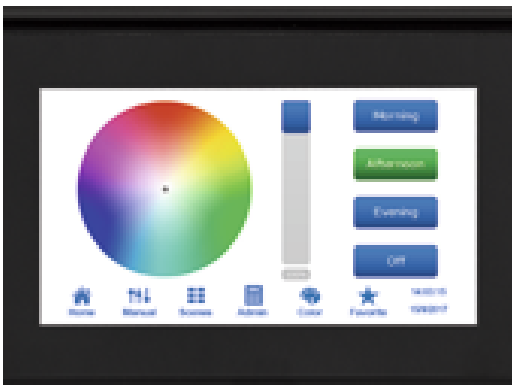

R2C Ready to Connect

Description	Part ID
R2C Ready to Connect (top)	430-0019

Fagerhult Lighting Ltd

33-34 Dolben Street, SE1 0UQ London, United Kingdom

<https://we-ef.com/uk>

Subject to technical changes and errors. - Generated on 10/03/2025

139-1913+139-1848

we-ef

FLC230-CC LED

DMX Wireless Antenna

Description	Part ID
Antenna RF5dB	430-0036
Antenna RF1.8dB	430-0018

Fagerhult Lighting Ltd

33-34 Dolben Street, SE1 0UQ London, United Kingdom

<https://we-ef.com/uk>

Subject to technical changes and errors. - Generated on 10/03/2025

Mounting Accessories

Floodlight mounting bracket TA

Description	Part ID	A	C1	D × L1	Weight (kg)	D × S
TA1 Mounting bracket, single (Ø 108 x 200)	147-0096		130	108 x 200	7.50	108 x 200

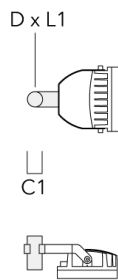

TA2 Mounting bracket, double (Ø 108 x 200)	147-0097		130	108 x 200	7.50	108 x 200
--	----------	--	-----	-----------	------	-----------

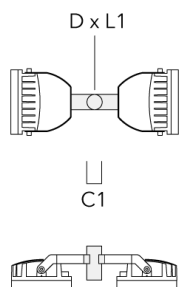

FLC230-CC LED

Description	Part ID	A	C1	D × L1	Weight (kg)	D × S
TA2-L Mounting bracket, double (Ø 108 x 200)	147-0148	±90°	420	108 x 200	20.20	108 x 200

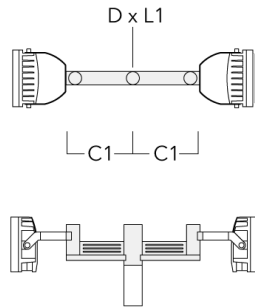

TA2-L Mounting bracket, double (Ø 76 x 200)	147-0105	±90°	420	76 x 200	16.10	76 x 200
---	----------	------	-----	----------	-------	----------

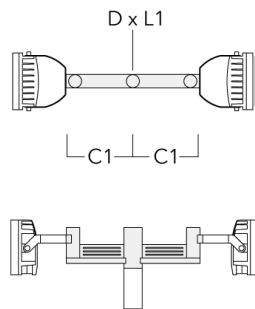

FLC230-CC LED

Description	Part ID	A	C1	D x L1	Weight (kg)	D x S
TA3 Mounting bracket, triple (Ø 89 x 200)	147-0025	±90°	650	89 x 200	17.90	89 x 200

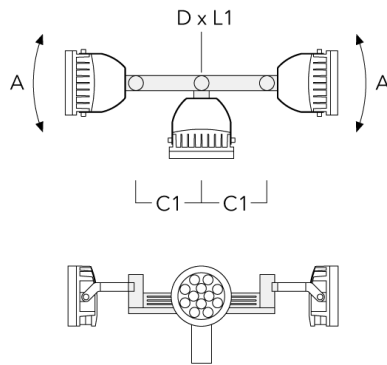

TA3 Mounting bracket, triple (Ø 108 x 200)	147-0098	±90°	650	108 x 200	24.20	108 x 200
--	----------	------	-----	-----------	-------	-----------

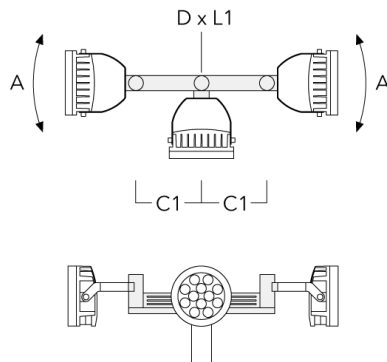

FLC230-CC LED

Description	Part ID	A	C1	D x L1	Weight (kg)	D x S
TA4 Mounting bracket, quad (Ø 89 x 200)	147-0099	±90°	650	89 x 200	20.80	89 x 200

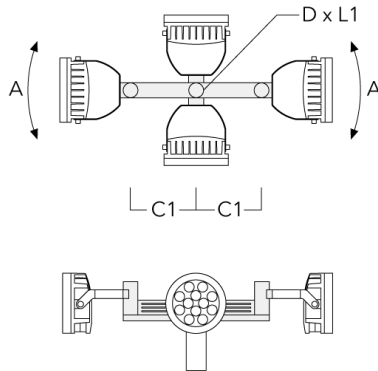

TA4 Mounting bracket, quad (Ø 108 x 200)	147-0100	±90°	650	108 x 200	24.20	108 x 200
--	----------	------	-----	-----------	-------	-----------

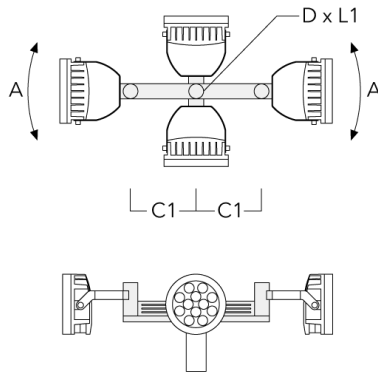

FLC230-CC LED

Description	Part ID	A	C1	D × L1	Weight (kg)	D × S
TA2 Mounting bracket, double* (Ø 76 x 200)	147-0024		130	76 x 200	1.90	76 x 200

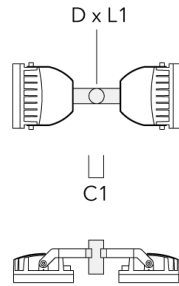

TA1 Mounting bracket, single* (Ø 76 x 200)	147-0023		130	76 x 200	1.50	76 x 200
--	----------	--	-----	----------	------	----------

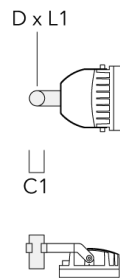

FLC230-CC LED

Pole clamp TS

Description	Part ID	D1	Weight (kg)	D
TS1-2/M12 Pole clamp, single (Ø 102-114)	147-0526	102-114	1.50	102-114

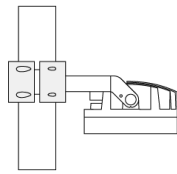
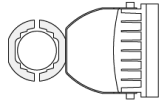

D1

TS1-2/M12 Pole clamp, single (Ø 114-133)	147-0544	114-133	1.70	114-133
--	----------	---------	------	---------

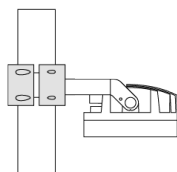
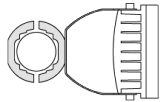

D1

FLC230-CC LED

Description	Part ID	D1	Weight (kg)	D
TS1-2/M12 Pole clamp, single (Ø 76-89)	147-0543	76-89	1.40	76-89

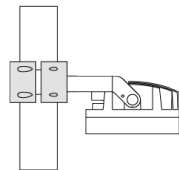
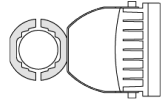

D1

TS2-2/M12 Pole clamp, double (Ø 76-89)	147-0545	76-89	1.40	76-89
--	----------	-------	------	-------

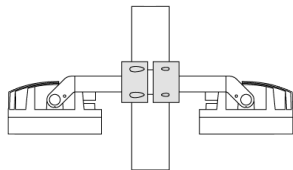
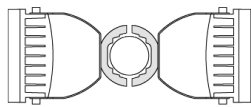

D1

FLC230-CC LED

Description	Part ID	D1	Weight (kg)	D
TS2-2/M12 Pole clamp, double (Ø 114-133)	147-0546	114-133	1.60	114-133

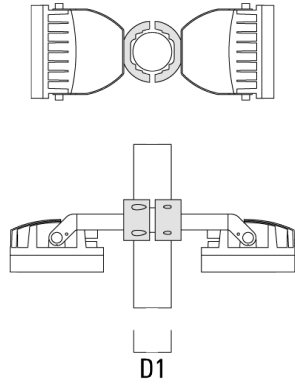

TS2-2/M12 Pole clamp, double (Ø 102-114)	147-0527	102-114	1.50	102-114
--	----------	---------	------	---------

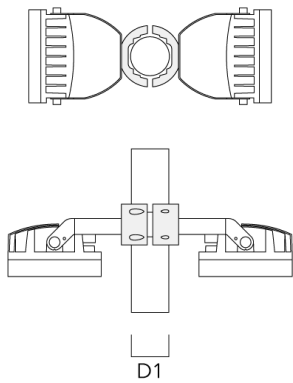

FLC230-CC LED

Planted root

Description	Part ID	D1	D2	D3	D4	H1	H2	M1	Weight(kg)
Planted root ESV4	300-0461	145	130	102	108	400	350	8	7.05

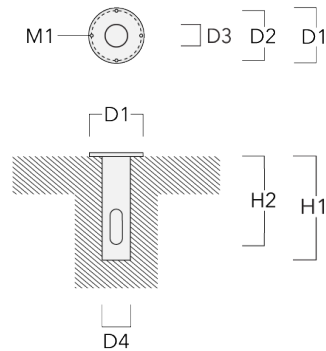

Pole clamp PC

Description	Part ID	D1	Weight (kg)
PC2 76-89/60 Pole clamp, double (Ø 76-89)	139-2703	76-89	1.00

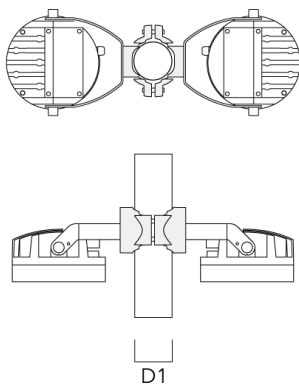

FLC230-CC LED

Description	Part ID	D1	Weight (kg)
PC1 76-89/60 Pole clamp, single (Ø 76-89)	139-2702	76-89	1.00

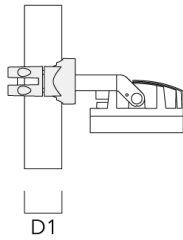
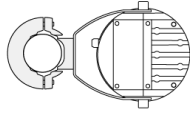

PC2 102-114/60 Pole clamp, double (Ø 102-114)	139-2707	102-114	1.20
---	----------	---------	------

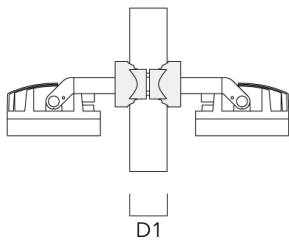
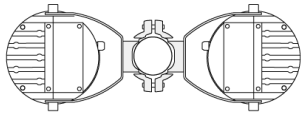

FLC230-CC LED

Description	Part ID	D1	Weight (kg)
PC1 102-114/60 Pole clamp, single (Ø 102-114)	139-2706	102-114	1.20

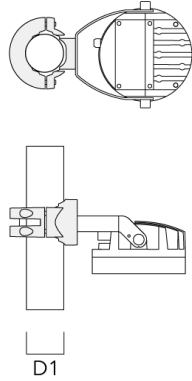

PC2 114-133/60 Pole clamp, double (Ø 114-133)	139-2709	114-133	1.40
--	----------	---------	------

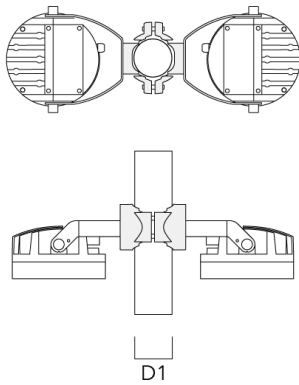

FLC230-CC LED

Description	Part ID	D1	Weight (kg)
PC1 114-133/60 Pole clamp, single (Ø 114-133)	139-2708	114-133	1.40

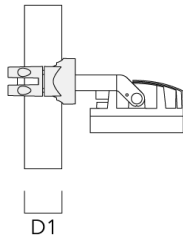
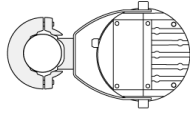

PC2 82-109/60 Pole camp, double (Ø 82-109)	139-2705	82-109	1.10
--	----------	--------	------

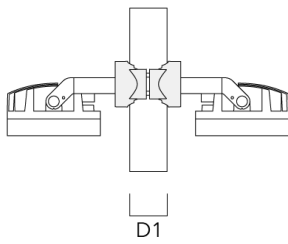
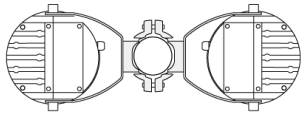

FLC230-CC LED

Description	Part ID	D1	Weight (kg)
PC1 82-109/60 Pole camp, single (Ø 82-109)	139-2704	82-109	1.10

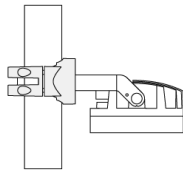
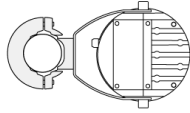

D1

FLC230-CC LED

Optical Accessories

Glare shield

Description	Part ID	A	C1
ES-FLC230-LED	139-1852	159	266

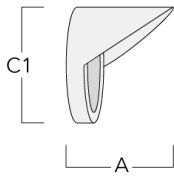

Snoot

Description	Part ID	A	C1
ET-FLC230-LED	139-1853	160	266

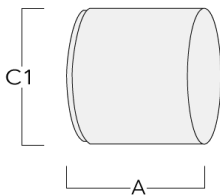

FLC230-CC LED

Linear spread lens

Description	Part ID	C1
IO-180-FLC230-LED	139-1849	199

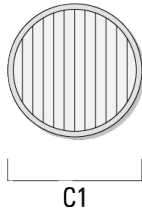

Flood lens

Description	Part ID	C1
IO-360-FLC230-LED	139-1850	199

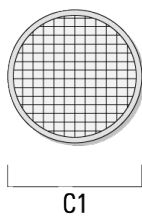

139-1913+139-1848

we-ef

FLC230-CC LED

Wallwash lens

Description	Part ID	C1
10-20-FLC230-LED	139-1848	199

