

## FLC260-CC LED

**Description**

RGBW/RGBA Colour Changer. IP66, Class I. Class II on request. IK07. Marine-grade, die-cast aluminium alloy. 5CE superior corrosion protection including PCS hardware. Silicone CCG® Controlled Compression Gasket. Safety glass lens. One cable gland. Second gland for through-wiring on request. Integral EC electronic converter, thermally separated. CAD-optimised optics for superior illumination and glare control. OLC® One LED Concept. Factory-installed LED circuit board with WE-EF Colour Boost Technology. With Colour Boost the targeted and selective control of individual channels or colours means that a higher power of the LEDs can be accessed than in total when all colours are simultaneously operated. The light output is thus maximized by targeted control of individual channels/colours.

DMX interface. For the M20 cable gland for network- and DMX-connection, WE-EF recommends a multi-core cable for DMX and power, "Power PUR-SR 3x1,5 + DMX".

|                    |                       |
|--------------------|-----------------------|
| Weight             | 18.00 kg              |
| Light distribution | wallwash              |
| Light source       | LED-36/144W - RGBW/4K |
| CRI                | 20/80                 |
| Power supply       | EC                    |
| LEDs               | 36                    |
| Rated input power  | 150 W                 |

**Nominal Lumen (lm)**

|             |       |
|-------------|-------|
| LED Lumen   | 340   |
| Total Lumen | 12240 |
| Tj          | 85    |

**Rated lumens (lm)**

|             |        |
|-------------|--------|
| LED Lumen   | 216.6  |
| Total Lumen | 7797.3 |
| Ta          | 25     |

**FLC260-CC LED**

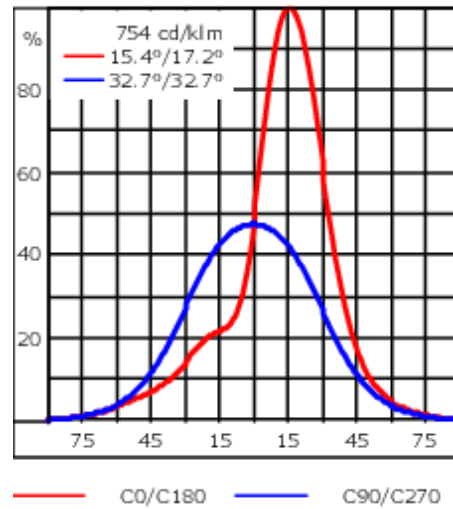
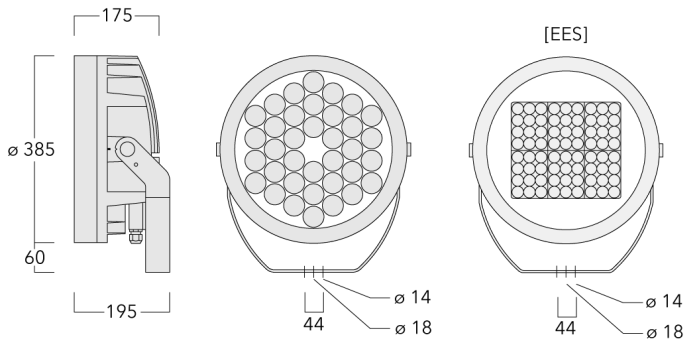

**Specifications**

**Material description**

|                      |                                                                                                                                                                                                                                                                                                                                                                                                                                                                                                                                                                                                                                                                                                                                                                                                                     |
|----------------------|---------------------------------------------------------------------------------------------------------------------------------------------------------------------------------------------------------------------------------------------------------------------------------------------------------------------------------------------------------------------------------------------------------------------------------------------------------------------------------------------------------------------------------------------------------------------------------------------------------------------------------------------------------------------------------------------------------------------------------------------------------------------------------------------------------------------|
| Body                 | Marine-grade, die-cast aluminium alloy                                                                                                                                                                                                                                                                                                                                                                                                                                                                                                                                                                                                                                                                                                                                                                              |
| Lens                 | Safety glass lens                                                                                                                                                                                                                                                                                                                                                                                                                                                                                                                                                                                                                                                                                                                                                                                                   |
| Colours              | <ul style="list-style-type: none"> <li><span style="display: inline-block; width: 15px; height: 15px; background-color: black; margin-right: 5px;"></span> RAL9004 Signal black</li> <li><span style="display: inline-block; width: 15px; height: 15px; background-color: #cccccc; margin-right: 5px;"></span> RAL9006 White aluminium</li> <li><span style="display: inline-block; width: 15px; height: 15px; background-color: #808080; margin-right: 5px;"></span> RAL9007 Grey aluminium</li> <li><span style="display: inline-block; width: 15px; height: 15px; background-color: #333333; margin-right: 5px;"></span> RAL7016 Anthracite grey</li> <li><span style="display: inline-block; width: 15px; height: 15px; background-color: #e0e0e0; margin-right: 5px;"></span> RAL9016 Traffic white</li> </ul> |
| Gasket               | Silicone CCG® Controlled Compression Gasket                                                                                                                                                                                                                                                                                                                                                                                                                                                                                                                                                                                                                                                                                                                                                                         |
| Fasteners            | PCS Polymer Coated Stainless Steel Hardware                                                                                                                                                                                                                                                                                                                                                                                                                                                                                                                                                                                                                                                                                                                                                                         |
| Ingress protection   | IP66                                                                                                                                                                                                                                                                                                                                                                                                                                                                                                                                                                                                                                                                                                                                                                                                                |
| Impact resistance    | IK07                                                                                                                                                                                                                                                                                                                                                                                                                                                                                                                                                                                                                                                                                                                                                                                                                |
| Corrosion resistance | 5CE                                                                                                                                                                                                                                                                                                                                                                                                                                                                                                                                                                                                                                                                                                                                                                                                                 |
| Windage              | 0.116 m <sup>2</sup>                                                                                                                                                                                                                                                                                                                                                                                                                                                                                                                                                                                                                                                                                                                                                                                                |

**Electrical description**

|                  |                        |
|------------------|------------------------|
| Power supply     | 220-240V / 50-60 Hz    |
| Driver / Ballast | DMX                    |
| Power factor     | > 0.9                  |
| Surge protection | 1/2 kV (optional SP10) |

**Additional information**

|                         |                        |
|-------------------------|------------------------|
| Lifetime                | Ta=25° L90B10 > 90000h |
| Energy efficiency class | G (Light source)       |

**Fagerhult Lighting Ltd**

33-34 Dolben Street, SE1 0UQ London, United Kingdom

<https://we-ef.com/uk>

Subject to technical changes and errors. - Generated on 10/03/2025

**FLC260-CC LED**

**Optical Accessories**

**Flood lens**

---

| Description       | Part ID  | C1  |
|-------------------|----------|-----|
| IO-360-FLC260-LED | 139-1862 | 332 |

---

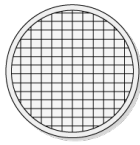

---

**Honeycomb louvre**

---

| Description                     | Part ID  | C1  | H1 |
|---------------------------------|----------|-----|----|
| IW-03-FLC260-LED - [E][EE][EES] | 139-1863 | 324 |    |

---

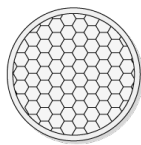

**FLC260-CC LED**

| Description         | Part ID  | C1  | H1  |
|---------------------|----------|-----|-----|
| IW-FLC26_EES-CC LED | 139-2434 | 232 | 209 |

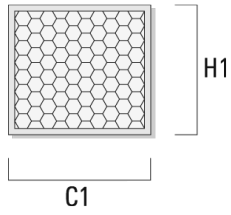

**Linear spread lens**

| Description          | Part ID  | C1  |
|----------------------|----------|-----|
| IO-180-FLC260-CC LED | 139-1861 | 332 |



**FLC260-CC LED**

**Wallwash lens**

---

| Description         | Part ID  | C1  |
|---------------------|----------|-----|
| IO-20-FLC260-CC LED | 139-1860 | 332 |

---



---

**Snoot**

---

| Description   | Part ID  | A   | C1  |
|---------------|----------|-----|-----|
| ET-FLC260-LED | 139-1865 | 222 | 393 |

---

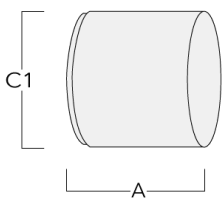

**FLC260-CC LED**

**Glare shield**

---

| Description   | Part ID  | A   | C1  |
|---------------|----------|-----|-----|
| ES-FLC260-LED | 139-1864 | 222 | 393 |

---



**Mounting Accessories**

**Pole clamp TS**

| Description                            | Part ID  | D1    | Weight (kg) | D     |
|----------------------------------------|----------|-------|-------------|-------|
| TS1-2/M12 Pole clamp, single (Ø 76-89) | 147-0543 | 76-89 | 1.40        | 76-89 |

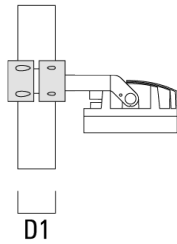
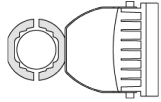

|                                          |          |         |      |         |
|------------------------------------------|----------|---------|------|---------|
| TS1-2/M12 Pole clamp, single (Ø 114-133) | 147-0544 | 114-133 | 1.70 | 114-133 |
|------------------------------------------|----------|---------|------|---------|

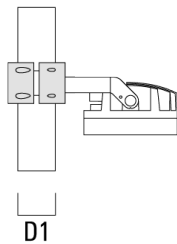
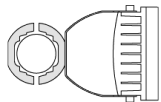

**FLC260-CC LED**

| Description                            | Part ID  | D1    | Weight (kg) | D     |
|----------------------------------------|----------|-------|-------------|-------|
| TS2-2/M12 Pole clamp, double (Ø 76-89) | 147-0545 | 76-89 | 1.40        | 76-89 |

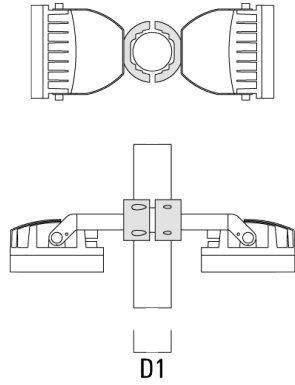

|                                          |          |         |      |         |
|------------------------------------------|----------|---------|------|---------|
| TS2-2/M12 Pole clamp, double (Ø 114-133) | 147-0546 | 114-133 | 1.60 | 114-133 |
|------------------------------------------|----------|---------|------|---------|

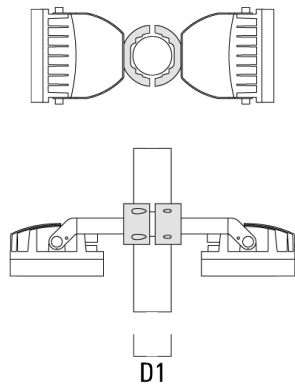



## FLC260-CC LED

## Floodlight mounting bracket TA

| Description                                | Part ID  | C1  | D × L1   | Weight (kg) | D × S    |
|--------------------------------------------|----------|-----|----------|-------------|----------|
| TA1 Mounting bracket, single* (Ø 76 x 200) | 147-0023 | 130 | 76 x 200 | 1.90        | 76 x 200 |

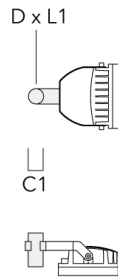

## Pole clamp PC

| Description                               | Part ID  | D1    | Weight (kg) |
|-------------------------------------------|----------|-------|-------------|
| PC2 76-89/60 Pole clamp, double (Ø 76-89) | 139-2703 | 76-89 | 1.00        |

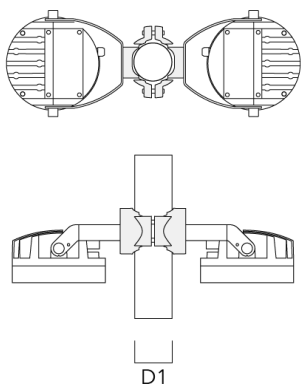

**FLC260-CC LED**

| Description                               | Part ID  | D1    | Weight (kg) |
|-------------------------------------------|----------|-------|-------------|
| PC1 76-89/60 Pole clamp, single (Ø 76-89) | 139-2702 | 76-89 | 1.00        |

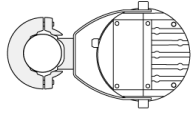

|                                               |          |         |      |
|-----------------------------------------------|----------|---------|------|
| PC2 102-114/60 Pole clamp, double (Ø 102-114) | 139-2707 | 102-114 | 1.20 |
|-----------------------------------------------|----------|---------|------|



**FLC260-CC LED**

| Description                                      | Part ID  | D1      | Weight (kg) |
|--------------------------------------------------|----------|---------|-------------|
| PC1 102-114/60 Pole clamp, single<br>(Ø 102-114) | 139-2706 | 102-114 | 1.20        |

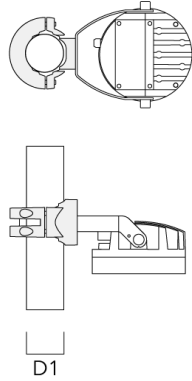

|                                                  |          |         |      |
|--------------------------------------------------|----------|---------|------|
| PC2 114-133/60 Pole clamp, double<br>(Ø 114-133) | 139-2709 | 114-133 | 1.40 |
|--------------------------------------------------|----------|---------|------|

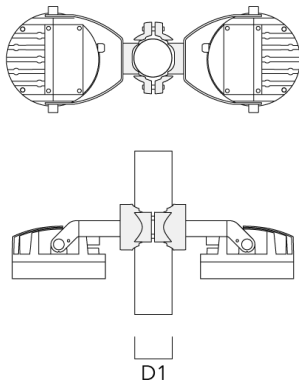

**FLC260-CC LED**

| Description                                      | Part ID  | D1      | Weight (kg) |
|--------------------------------------------------|----------|---------|-------------|
| PC1 114-133/60 Pole clamp, single<br>(Ø 114-133) | 139-2708 | 114-133 | 1.40        |



|                                            |          |        |      |
|--------------------------------------------|----------|--------|------|
| PC2 82-109/60 Pole camp, double (Ø 82-109) | 139-2705 | 82-109 | 1.10 |
|--------------------------------------------|----------|--------|------|



**FLC260-CC LED**

---

| Description                                | Part ID  | D1     | Weight (kg) |
|--------------------------------------------|----------|--------|-------------|
| PC1 82-109/60 Pole camp, single (Ø 82-109) | 139-2704 | 82-109 | 1.10        |

---



D1

**FLC260-CC LED**

**Control**

**DMX Controller**

---

| Description    | Part ID  |
|----------------|----------|
| DMX Controller | 400-0469 |

---

**DMX Controller (smart)**

---

| Description            | Part ID  | Additional information                                                                                                                  |
|------------------------|----------|-----------------------------------------------------------------------------------------------------------------------------------------|
| DMX Controller (smart) | 400-0470 | IP20. The Touch Panel is an intuitive and easy-to-use keypad or one DMX universe. It can store up to 36 scenes; alternatively, via .... |

---



**FLC260-CC LED**

**DMX Controller - RDM ready**

| Description                | Part ID  |
|----------------------------|----------|
| DMX Controller - RDM ready | 400-0471 |



**DMX Splitter**

| Description  | Part ID  |
|--------------|----------|
| DMX Splitter | 400-0473 |



**FLC260-CC LED**

**DMX Booster Box**

---

| Description     | Part ID  |
|-----------------|----------|
| DMX Booster Box | 400-0474 |

---



---

**DMX Motion Sensor**

---

| Description       | Part ID  |
|-------------------|----------|
| DMX Motion Sensor | 400-0478 |

---





**FLC260-CC LED**

**DMX Termination Plug**

---

| Description          | Part ID  |
|----------------------|----------|
| DMX Termination Plug | 400-0475 |

---



---

**DMX Plug and Socket**

---

| Description         | Part ID  |
|---------------------|----------|
| DMX Plug and Socket | 400-0479 |

---



**FLC260-CC LED**

**DMX Combination Cable**

---

| Description           | Part ID  |
|-----------------------|----------|
| DMX Combination Cable | 400-0480 |

---



---

**DMX Wireless Repeater**

---

| Description           | Part ID  |
|-----------------------|----------|
| DMX Wireless Repeater | 400-0477 |

---



**FLC260-CC LED**

**DMX Wireless Transceiver**

---

| Description              | Part ID  |
|--------------------------|----------|
| DMX Wireless Transceiver | 400-0476 |

---



---

**DMX Controller (smart) - RDM ready**

---

| Description                        | Part ID  |
|------------------------------------|----------|
| DMX Controller (smart) - RDM ready | 400-0472 |

---

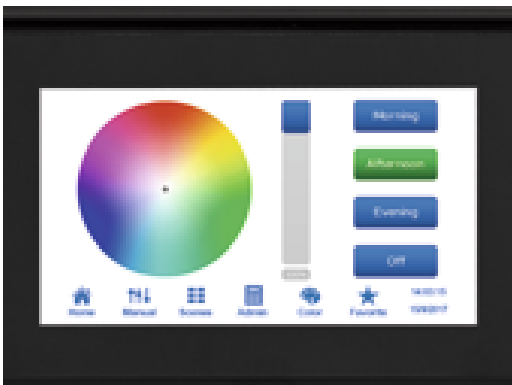

---

**DMX Wireless Antenna**

---

| Description   | Part ID  |
|---------------|----------|
| Antenna RF5dB | 430-0036 |

---

**Fagerhult Lighting Ltd**

33-34 Dolben Street, SE1 0UQ London, United Kingdom

<https://we-ef.com/uk>

Subject to technical changes and errors. - Generated on 10/03/2025

**139-1889+139-1860**

**we-ef**

**FLC260-CC LED**

| Description     | Part ID  |
|-----------------|----------|
| Antenna RF1.8dB | 430-0018 |

**Fagerhult Lighting Ltd**

33-34 Dolben Street, SE1 0UQ London, United Kingdom

<https://we-ef.com/uk>

Subject to technical changes and errors. - Generated on 10/03/2025