

FLC260 LED COLOR CHANGER

**Description**

RGBW/RGBA Color Changer.

IP66. Class I. IK07. Marine-grade, die-cast aluminum alloy. 5CE superior corrosion protection including PCS hardware. Silicone CCG® Controlled Compression Gasket. Safety glass lens. One cable gland, second gland for through wiring on request. CAD-optimized optics for superior illumination and glare control. Integral driver, thermally separated. OLC® One LED Concept. Factory-installed LED circuit board. DMX interface.

For the M20 cable gland for network- and DMX-connection, WE-EF recommends a multi-core cable for DMX and power, "Power PUR-SR 3x1.5 + DMX".

Color Boost technology:

With Color Boost the targeted and selective control of individual channels or colors means that a higher power of the LEDs can be accessed than in total when all colors are simultaneously operated. The light output is thus maximized by targeted control of individual channels/colors.

Specify product with 7 Digit product code - Finish Color. Accessories, such as mounting, optical, and electrical, must

| | |
|--------------------|-----------------------|
| Weight | 39.68 lb |
| Light distribution | wallwash |
| Light source | LED-36/144W - RGBW/4K |
| CRI | 80 |
| Power supply | electronic gear |
| LEDs | 36 |
| Rated input power | 150 W |

Nominal Lumen (lm)

| | |
|-------------|-------|
| LED Lumen | 340 |
| Total Lumen | 12240 |
| Tj | 85 |

Delivered lumens (lm)

| | |
|-------------|--------|
| LED Lumen | 216.6 |
| Total Lumen | 7797.3 |
| Ta | 25 |

WE-EF LIGHTING USA, LLC

410-D Keystone Drive, 15086 Warrendale, PA 15086 - Phone: +1 724 742 0030
 customersupport.usa@we-ef.com - <https://we-ef.com/us>
 Subject to technical changes and errors. - Generated on 03/10/2025

139-1889+139-1860

we-ef

FLC260 LED COLOR CHANGER

be specified separately.

Example: XXX-XXXX-9004 (Black)

+ XXX-XXXX (Accessory 1)

WE-EF LIGHTING USA, LLC

410-D Keystone Drive, 15086 Warrendale, PA 15086 - Phone: +1 724 742 0030

customersupport.usa@we-ef.com - <https://we-ef.com/us>

Subject to technical changes and errors. - Generated on 03/10/2025

FLC260 LED COLOR CHANGER

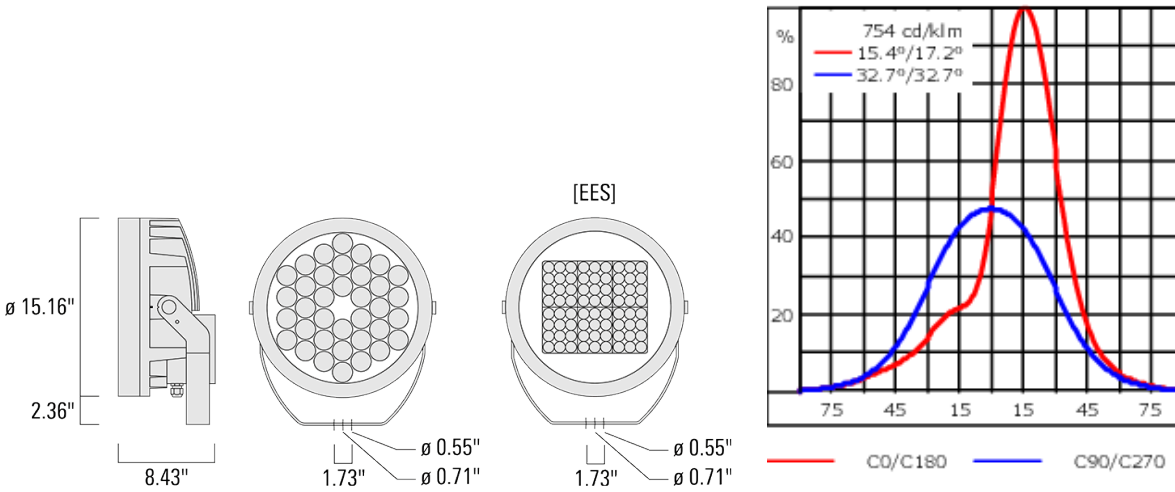

Specifications

Material description

| | |
|----------------------|---|
| Body | Marine-grade, die-cast aluminium alloy |
| Lens | Safety glass lens |
| Colors | <div style="display: flex; flex-direction: column; gap: 5px;"> <div> RAL9004 Black</div> <div> RAL9007 Grey Metallic</div> <div> RAL9016 White</div> <div> RAL8019 Dark Bronze</div> </div> |
| Gasket | Silicone CCG® Controlled Compression Gasket |
| Fasteners | PCS Polymer Coated Stainless Steel Hardware |
| Ingress protection | IP66 |
| Impact resistance | IK07 |
| Corrosion resistance | 5CE |
| Windage | 1.5 |

WE-EF LIGHTING USA, LLC

410-D Keystone Drive, 15086 Warrendale, PA 15086 - Phone: +1 724 742 0030

customersupport.usa@we-ef.com - <https://we-ef.com/us>

Subject to technical changes and errors. - Generated on 03/10/2025

139-1889+139-1860

we-ef

FLC260 LED COLOR CHANGER

Electrical description

| | |
|------------------|---|
| Power supply | Integral [ECG] electronic driver 120V-277V. |
| Driver / Ballast | DMX |
| Power factor | > 0.9 |
| Surge protection | Integral 10kV Surge Protector |

Additional information

| | |
|----------|--|
| Lifetime | Ta=25°/40° L90B10 > 90000h |
| Listings | ETL, UL-1598, CSA-C22.2#250.0. Suitable for Wet Locations. |

WE-EF LIGHTING USA, LLC

410-D Keystone Drive, 15086 Warrendale, PA 15086 - Phone: +1 724 742 0030
customersupport.usa@we-ef.com - <https://we-ef.com/us>
Subject to technical changes and errors. - Generated on 03/10/2025

FLC260 LED COLOR CHANGER

Optical Accessories

Softening Lens

| Description | Part ID | C1 |
|-------------------|----------|-------|
| 10-360-FLC260-LED | 139-1862 | 13.07 |

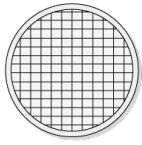

C1

FLC260 LED COLOR CHANGER

Honeycomb louvre

| Description | Part ID | C1 | H1 |
|-------------------|----------|-------|----|
| IW-360-FLC260-LED | 139-1863 | 12.76 | |

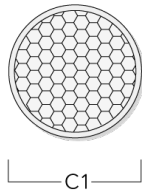

| | | | |
|---------------------|----------|------|------|
| IW-FLC26_EES-CC LED | 139-2434 | 9.13 | 8.22 |
|---------------------|----------|------|------|

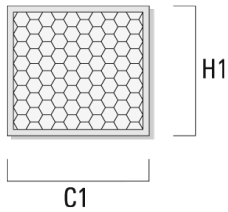

WE-EF LIGHTING USA, LLC

410-D Keystone Drive, 15086 Warrendale, PA 15086 - Phone: +1 724 742 0030
customersupport.usa@we-ef.com - <https://we-ef.com/us>
Subject to technical changes and errors. - Generated on 03/10/2025

FLC260 LED COLOR CHANGER

Linear spread lens

| Description | Part ID | C1 |
|----------------------|----------|-------|
| 10-180-FLC260-CC LED | 139-1861 | 13.07 |

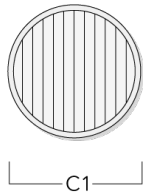

Wallwash lens

| Description | Part ID | C1 |
|---------------------|----------|-------|
| 10-20-FLC260-CC LED | 139-1860 | 13.07 |

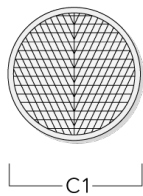

WE-EF LIGHTING USA, LLC

410-D Keystone Drive, 15086 Warrendale, PA 15086 - Phone: +1 724 742 0030
customersupport.usa@we-ef.com - <https://we-ef.com/us>
Subject to technical changes and errors. - Generated on 03/10/2025

FLC260 LED COLOR CHANGER

Snoot

| Description | Part ID | A | C1 |
|------------------|----------|------|-------|
| ET-FLC260-CC-LED | 139-6976 | 8.74 | 15.47 |
| ET-FLC260-LED | 139-1865 | 8.74 | 15.47 |

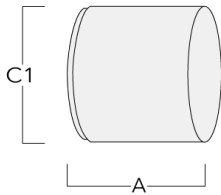

Glare shield

| Description | Part ID | A | C1 |
|------------------|----------|------|-------|
| ES-FLC260-CC-LED | 139-6972 | 8.74 | 15.47 |

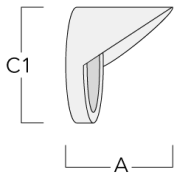

WE-EF LIGHTING USA, LLC

410-D Keystone Drive, 15086 Warrendale, PA 15086 - Phone: +1 724 742 0030
 customersupport.usa@we-ef.com - <https://we-ef.com/us>
 Subject to technical changes and errors. - Generated on 03/10/2025

139-1889+139-1860

we-ef

FLC260 LED COLOR CHANGER

| Description | Part ID | A | C1 |
|---------------|----------|------|-------|
| ES-FLC260-LED | 139-1864 | 8.74 | 15.47 |

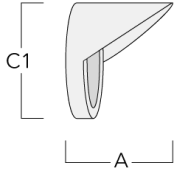

WE-EF LIGHTING USA, LLC

410-D Keystone Drive, 15086 Warrendale, PA 15086 - Phone: +1 724 742 0030
customersupport.usa@we-ef.com - <https://we-ef.com/us>
Subject to technical changes and errors. - Generated on 03/10/2025

FLC260 LED COLOR CHANGER

Mounting Accessories

Pole clamp TS

| Description | Part ID | D1 | Weight (lb) | D |
|--|----------|----------|-------------|-------|
| TS1-2/M12 Pole clamp, single (Ø 3"-3.5") | 147-0543 | 3.0-3.50 | 3.31 | 76-89 |

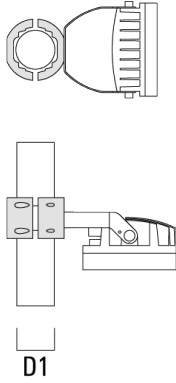

| | | | | |
|---|----------|----------|------|---------|
| TS1-2/M16 Pole clamp, single (Ø 4.5"-5.25") | 147-0544 | 4.5-5.25 | 1.70 | 114-133 |
|---|----------|----------|------|---------|

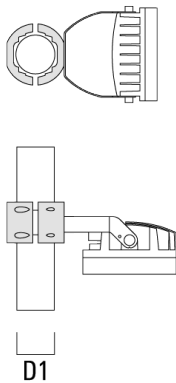

WE-EF LIGHTING USA, LLC

410-D Keystone Drive, 15086 Warrendale, PA 15086 - Phone: +1 724 742 0030
 customersupport.usa@we-ef.com - <https://we-ef.com/us>
 Subject to technical changes and errors. - Generated on 03/10/2025

FLC260 LED COLOR CHANGER

| Description | Part ID | D1 | Weight (lb) | D |
|--|----------|-----------|-------------|-------|
| TS2-2/M16 Pole clamp, double (Ø 3"-3.5") | 147-0545 | 3.0"-3.5" | 3.09 lbs | 76-89 |

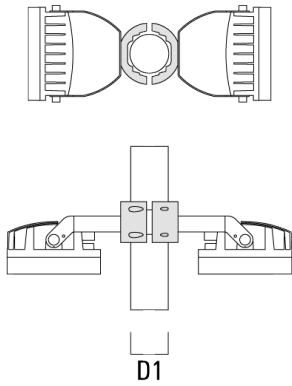

| | | | | |
|---|----------|-----------|------|---------|
| TS2-2/M12 Pole clamp, double (Ø 4.5"-5.25") | 147-0546 | 4.50-5.25 | 3.53 | 114-133 |
|---|----------|-----------|------|---------|

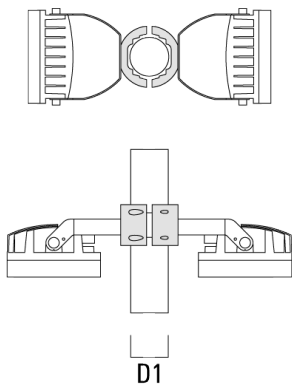

WE-EF LIGHTING USA, LLC

410-D Keystone Drive, 15086 Warrendale, PA 15086 - Phone: +1 724 742 0030
 customersupport.usa@we-ef.com - <https://we-ef.com/us>
 Subject to technical changes and errors. - Generated on 03/10/2025

FLC260 LED COLOR CHANGER

Pole top caps KF

| Description | Part ID | D1 | D × L1 | Weight (lb) | D |
|----------------------------------|----------|------|----------|-------------|----------|
| KF16-60/M16 Spigot Cap (Ø 2.36") | 310-9120 | 2.36 | 2.36 x 4 | 4.4 lbs | 60 x 100 |

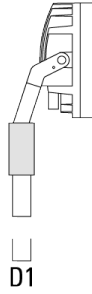

| | | | | | |
|--------------------------------|----------|---|-------|----------|----------|
| KF1-76/M16 Spigot Cap (Ø 3.0") | 310-9121 | 3 | 3 x 4 | 1.10 lbs | 76 x 100 |
|--------------------------------|----------|---|-------|----------|----------|

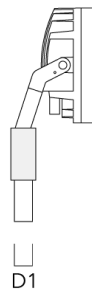

WE-EF LIGHTING USA, LLC

410-D Keystone Drive, 15086 Warrendale, PA 15086 - Phone: +1 724 742 0030
customersupport.usa@we-ef.com - <https://we-ef.com/us>

Subject to technical changes and errors. - Generated on 03/10/2025

FLC260 LED COLOR CHANGER

| Description | Part ID | D1 | D × L1 | Weight (lb) | D |
|---------------------------------|----------|------|---------|-------------|----|
| KF16-89/M16 Spigot Cap (Ø 3.5") | 300-0734 | 3.50 | 3.5 x 3 | 1.10 lbs | 89 |

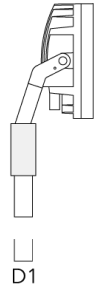

| | | | | | |
|-----------------------------------|----------|------|----------|---------|-----|
| KF16-108/M16 Spigot Cap (Ø 4.25") | 300-0735 | 4.25 | 4.25 x 3 | 4.4 lbs | 108 |
|-----------------------------------|----------|------|----------|---------|-----|

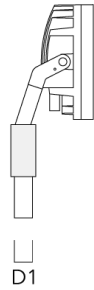

WE-EF LIGHTING USA, LLC

410-D Keystone Drive, 15086 Warrendale, PA 15086 - Phone: +1 724 742 0030
customersupport.usa@we-ef.com - <https://we-ef.com/us>
Subject to technical changes and errors. - Generated on 03/10/2025

FLC260 LED COLOR CHANGER

Short post EM

| Description | Part ID | D1 | D2 | H1 | M1 | Weight (lb) |
|-------------|----------|------|-------|----|-------|-------------|
| EM1-M16 AL | 270-0001 | 6.3" | 5.12" | 8" | 0.35" | 4.85 lbs |

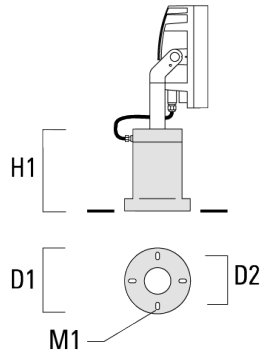

Surface Mount Canopy SMC

| Description | Part ID | D1 | D2 | Weight (lb) |
|-------------|----------|-------|------|-------------|
| SMC-200 | 147-6915 | 10.83 | 9.25 | 15.4 lbs |

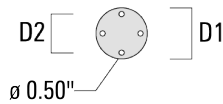

WE-EF LIGHTING USA, LLC

410-D Keystone Drive, 15086 Warrendale, PA 15086 - Phone: +1 724 742 0030

customersupport.usa@we-ef.com - <https://we-ef.com/us>

Subject to technical changes and errors. - Generated on 03/10/2025

FLC260 LED COLOR CHANGER

Pole clamp PC

| Description | Part ID | D1 | Weight (lb) |
|---|----------|----------|-------------|
| PC2 76-89/60 Pole clamp, double (Ø 3"-3.5") | 139-2703 | 3.0-3.50 | 2.20 |

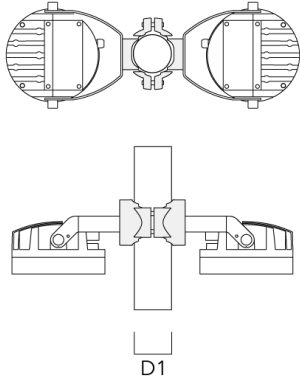

| | | | |
|---|----------|----------|------|
| PC1 76-89/60 Pole clamp, single (Ø 3"-3.5") | 139-2702 | 3.0-3.50 | 2.20 |
|---|----------|----------|------|

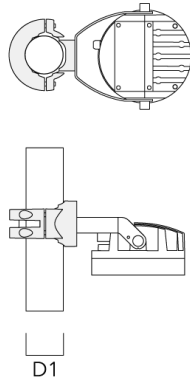

WE-EF LIGHTING USA, LLC

410-D Keystone Drive, 15086 Warrendale, PA 15086 - Phone: +1 724 742 0030
 customersupport.usa@we-ef.com - <https://we-ef.com/us>
 Subject to technical changes and errors. - Generated on 03/10/2025

FLC260 LED COLOR CHANGER

| Description | Part ID | D1 | Weight (lb) |
|--|----------|----------|-------------|
| PC2 102-114/60 Pole clamp, double (Ø 4"-4.5") | 139-2707 | 4.0-4.50 | 2.65 |

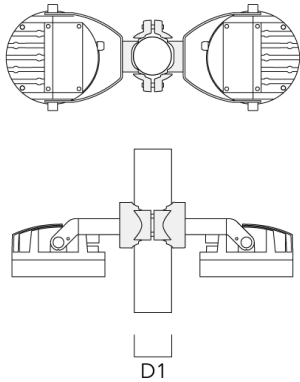

| | | | |
|--|----------|----------|------|
| PC1 102-114/60 Pole clamp, single (Ø 4"-4,5") | 139-2706 | 4.0-4.50 | 2.65 |
|--|----------|----------|------|



WE-EF LIGHTING USA, LLC

410-D Keystone Drive, 15086 Warrendale, PA 15086 - Phone: +1 724 742 0030
 customersupport.usa@we-ef.com - <https://we-ef.com/us>
 Subject to technical changes and errors. - Generated on 03/10/2025

FLC260 LED COLOR CHANGER

| Description | Part ID | D1 | Weight (lb) |
|---|----------|----------|-------------|
| PC2 114-133/60 Pole clamp, double (Ø 4.5"-5.25") | 139-2709 | 4.5-5.25 | 3.10 |

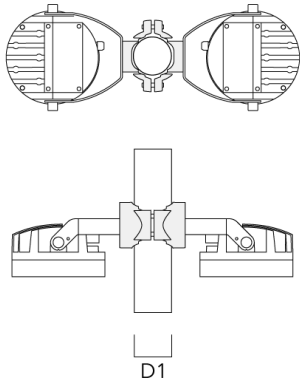

| | | | |
|---|----------|----------|------|
| PC1 114-133/60 Pole clamp, single (Ø 4.5"-5.25") | 139-2708 | 4.5-5.25 | 3.10 |
|---|----------|----------|------|



FLC260 LED COLOR CHANGER

| Description | Part ID | D1 | Weight (lb) |
|---|----------|-----------|-------------|
| PC2 82-109/60 Pole clamp, double (Ø 3.25"-4.25") | 139-2705 | 3.20-4.30 | 2.40 |



| | | | |
|--|----------|-----------|------|
| PC1 82-109/60 Pole camp, single (Ø 3.25"-4.3") | 139-2704 | 3.20-4.30 | 2.40 |
|--|----------|-----------|------|



WE-EF LIGHTING USA, LLC

410-D Keystone Drive, 15086 Warrendale, PA 15086 - Phone: +1 724 742 0030
 customersupport.usa@we-ef.com - <https://we-ef.com/us>
 Subject to technical changes and errors. - Generated on 03/10/2025

FLC260 LED COLOR CHANGER

Control

DMX Controller

| Description | Part ID |
|----------------|----------|
| DMX Controller | 400-0469 |

DMX Controller (smart)

| Description | Part ID | Additional information |
|------------------------|----------|---|
| DMX Controller (smart) | 400-0470 | IP20. The Touch Panel is an untutive abd easy-to use keypad or one DMX universe. It can store up to 36 scences; alternatively, via |



FLC260 LED COLOR CHANGER

DMX Controller - RDM ready

| Description | Part ID |
|----------------------------|----------|
| DMX Controller - RDM ready | 400-0471 |



DMX Splitter

| Description | Part ID |
|--------------|----------|
| DMX Splitter | 400-0473 |



WE-EF LIGHTING USA, LLC

410-D Keystone Drive, 15086 Warrendale, PA 15086 - Phone: +1 724 742 0030
customersupport.usa@we-ef.com - <https://we-ef.com/us>
Subject to technical changes and errors. - Generated on 03/10/2025

FLC260 LED COLOR CHANGER

DMX Booster Box

| Description | Part ID |
|-----------------|----------|
| DMX Booster Box | 400-0474 |



DMX Termination Plug

| Description | Part ID |
|----------------------|----------|
| DMX Termination Plug | 400-0475 |



WE-EF LIGHTING USA, LLC

410-D Keystone Drive, 15086 Warrendale, PA 15086 - Phone: +1 724 742 0030
 customersupport.usa@we-ef.com - <https://we-ef.com/us>
 Subject to technical changes and errors. - Generated on 03/10/2025

139-1889+139-1860

we-ef

FLC260 LED COLOR CHANGER

DMX Plug and Socket

| Description | Part ID |
|---------------------|----------|
| DMX Plug and Socket | 400-0479 |



DMX Combination Cable

| Description | Part ID |
|-----------------------|----------|
| DMX Combination Cable | 400-0480 |



WE-EF LIGHTING USA, LLC

410-D Keystone Drive, 15086 Warrendale, PA 15086 - Phone: +1 724 742 0030

customersupport.usa@we-ef.com - <https://we-ef.com/us>

Subject to technical changes and errors. - Generated on 03/10/2025

FLC260 LED COLOR CHANGER

DMX Wireless Repeater

| Description | Part ID |
|-----------------------|----------|
| DMX Wireless Repeater | 400-0477 |



DMX Wireless Transceiver

| Description | Part ID |
|--------------------------|----------|
| DMX Wireless Transceiver | 400-0476 |



WE-EF LIGHTING USA, LLC

410-D Keystone Drive, 15086 Warrendale, PA 15086 - Phone: +1 724 742 0030
customersupport.usa@we-ef.com - <https://we-ef.com/us>
Subject to technical changes and errors. - Generated on 03/10/2025

139-1889+139-1860

we-ef

FLC260 LED COLOR CHANGER

DMX Controller (smart) - RDM ready

| Description | Part ID |
|------------------------------------|----------|
| DMX Controller (smart) - RDM ready | 400-0472 |



WE-EF LIGHTING USA, LLC

410-D Keystone Drive, 15086 Warrendale, PA 15086 - Phone: +1 724 742 0030
customersupport.usa@we-ef.com - <https://we-ef.com/us>
Subject to technical changes and errors. - Generated on 03/10/2025