



Description

IP66, Class I. Class II on request. IK07. Marine-grade, die-cast aluminium alloy. 5CE superior corrosion protection including PCS hardware. Silicone CCG® gasket. Safety glass lens. Two cable entries. Integral EC electronic converter in thermally separated compartment. CAD-optimised optics for superior illumination and glare control. OLC®One LED Concept. Factory installed LED circuit board. The luminaire is factory-sealed and does not need to be opened during the installation.

Optional 2200 K version available. To be specified at time of ordering.

Suitable for mounting up to max. 40 mm ceiling thickness. A pre-installation blockout, proud or flush, is available and recommended for mounting in concrete ceilings. To be ordered separately.

The luminaire is not suitable for chlorine containing environments e.g. swimming pool. Special version suitable for chlorine containing environments, on request. Must be specified at time of ordering.

Weight	4.00 kg
Light distribution	symmetric, very narrow beam, sharp cut-off [EES]
Light source	LED-24/48W / 700 mA - 4000 K
CRI	80
Power supply	EC
LEDs	24
Rated input power	54 W

Nominal Lumen (lm)

LED Lumen	310
Total Lumen	7440
Tj	85

Rated lumens (lm)

LED Lumen	287
Total Lumen	6887
Ta	25

134-1759



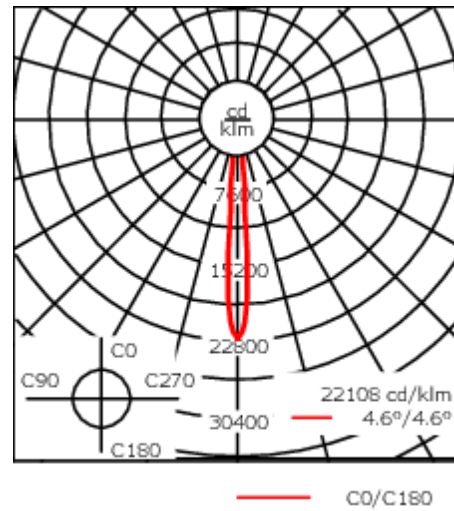
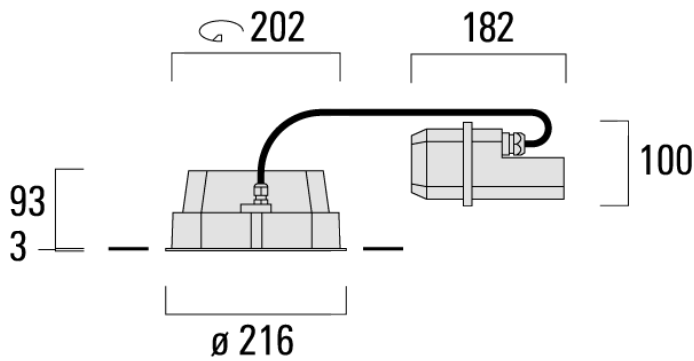

DOC140 LED

we-ef



Specifications

Material description

Body	Marine-grade, die-cast aluminium alloy
Lens	Safety glass lens
Colours	 RAL9004 Signal black  RAL9006 White aluminium  RAL9007 Grey aluminium  RAL7016 Anthracite grey  RAL9016 Traffic white
Gasket	Silicone CCG® Controlled Compression Gasket
Fasteners	PCS Polymer Coated Stainless Steel Hardware
Ingress protection	IP66
Impact resistance	IK07
Corrosion resistance	5CE

Fagerhult Lighting Ltd

33-34 Dolben Street, SE1 0UQ London, United Kingdom

<https://we-ef.com/uk>

Subject to technical changes and errors. - Generated on 23/11/2024

134-1759

DOC140 LED

we-ef

Electrical description

Power supply	220-240V / 50-60 Hz
Driver / Ballast	Standard. Optional DALI version available. To be specified at time of ordering.
Surge protection	6/6 kV

Additional information

Lifetime	Ta=25° L90B10 > 90000h
Energy efficiency class	C-D (Light source)

134-1759

DOC140 LED

we-ef

Control

DALI interface

Description	Part ID	C
DALI interface	430-0013	90

Optical Accessories

Linear spread lens

Description	Part ID	C1
IO-180-DOC140-LED	134-1760	160



Flood lens

Description	Part ID	C1
IO-360-DOC140-LED	134-1762	160



134-1759

DOC140 LED

we-ef

Wallwash lens

Description	Part ID	C1
IO-20-WW-DOC140-LED	134-1761	160



C1

Mounting Accessories

Installation blackout, proud

Description	Part ID	A	B	C1	D1
BDO14-I	134-1763	443	324	192	216



Installation blackout, flush with shadow line

Description	Part ID	A	B	C1	D1	D2
BDO14-III	134-1764	443	324	192	216	267

