



Description

IP66. Classe I. IK07. Corps en fonte d'aluminium. Visserie inox avec traitement PCS. Protection contre la corrosion 5CE. Joint silicone. Verre de sécurité. Luminaire contrôlé via le protocole DALI en standard.

Version en 2200K disponible sauf pour la photométrie [EES].

Poids	4.30 kg
Distribution de la lumière	faisceau symétrique, extensif [B]
Source lumineuse	LED-6/12W / 700 mA - 3000 K
IRC	80
Alimentation électrique	ballast électronique
LEDs	6
Rated input power	14.5 W
Flux lumineux nominal (lm)	
LED Lumen	290
Total Lumen	1740
Tj	85
Rated lumens (lm)	
LED Lumen	248.7
Total Lumen	1492
Ta	25

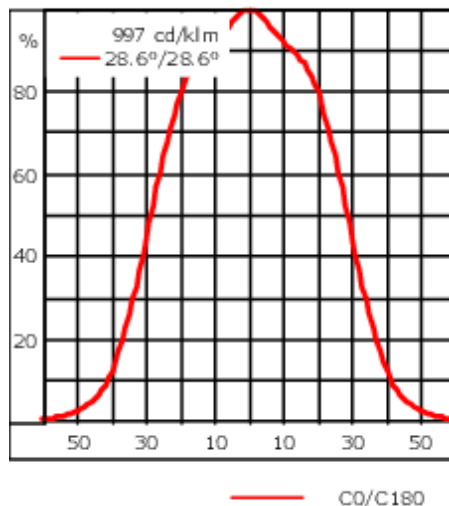
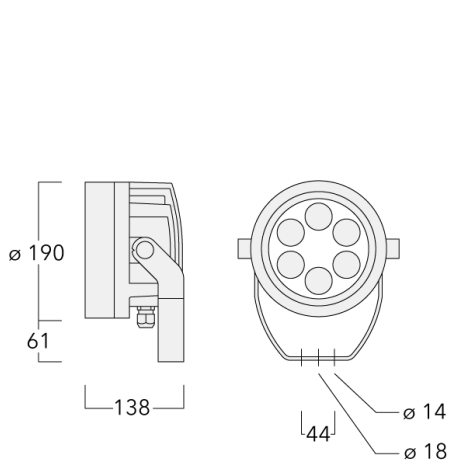

Spécifications

Description du matériel

Corps	Corps en fonte d'aluminium, visserie inox avec traitement PCS
Lentille	Safety glass lens
Couleurs	<div style="display: flex; align-items: center; gap: 10px;"> <div style="width: 20px; height: 15px; background-color: black; margin-right: 5px;"></div> RAL9004 Noir de sécurité </div> <div style="display: flex; align-items: center; gap: 10px;"> <div style="width: 20px; height: 15px; background-color: gray; margin-right: 5px;"></div> RAL9007 Aluminium gris </div> <div style="display: flex; align-items: center; gap: 10px;"> <div style="width: 20px; height: 15px; background-color: darkgray; margin-right: 5px;"></div> RAL7016 Gris anthracite </div> <div style="display: flex; align-items: center; gap: 10px;"> <div style="width: 20px; height: 15px; background-color: lightgray; margin-right: 5px;"></div> RAL9016 Blanc signalisation </div>
Joint	Joint silicone CCG®
Visserie	PCS Inox avec recouvrement polymère
IP	IP66
IK	IK07
Protection contre la corrosion	5CE
Surface exposée au vent	0.030 m ²

Description électrique

Alimentation électrique	220-240V / 50-60 Hz
Driver	Standard - version DALI disponible en option
Protection contre les surtensions	6/6 kV (optional SP10)

WE-EF Switzerland AG

Himmelrichstrasse 6, 6003 Luzern - Téléphone: +41 22 752 49 94

info.switzerland@we-ef.com - https://we-ef.com/ch_fr

Sous réserve de modifications techniques et d'erreurs. - Généré le 23/10/2024

139-1999

FLC220 LED

we-ef

Informations complémentaires

Durée de vie Ta=25° L90B10 > 90000h

Classe d'efficacité
énergétique C-D

WE-EF Switzerland AG

Himmelrichstrasse 6, 6003 Luzern - Téléphone: +41 22 752 49 94

info.switzerland@we-ef.com - https://we-ef.com/ch_fr

Sous réserve de modifications techniques et d'erreurs. - Généré le 23/10/2024

Accessoires d'installation

Socle de montage EM

Description	Référence	D1	D2	H1	M1	Poids (kg)
EM1-M16 socle de montage	270-9038	160	130	203	9	2

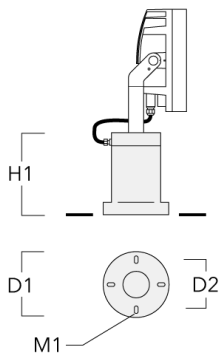

Traverse pour mâts

Description	Référence	A	C1	D x L1	Poids (kg)	D x S
TA1 traverse simple (Ø 108 x 200)	147-0096		130	108 x 200	7.50	108 x 200

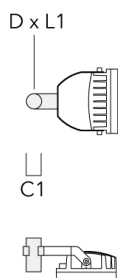

Description	Référence	A	C1	D x L1	Poids (kg)	D x S
TA2 traverse double (Ø 108 x 200)	147-0097		130	108 x 200	7.50	108 x 200

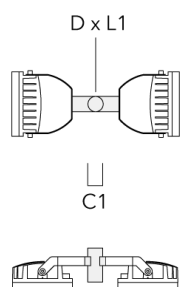

TA3 traverse triple orientable (Ø 89 x 200)	147-0025	$\pm 90^\circ$	650	89 x 200	17.90	89 x 200
---------------------------------------------	----------	----------------	-----	----------	-------	----------

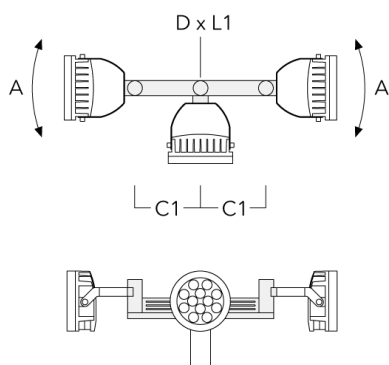

Description	Référence	A	C1	D x L1	Poids (kg)	D x S
TA3 traverse triple orientable (Ø 108 x 200)	147-0098	±90°	650	108 x 200	24.20	108 x 200

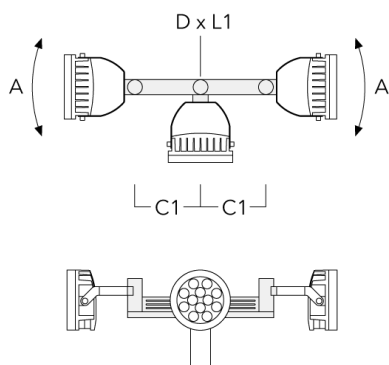

TA2 traverse double (Ø 76 x 200)	147-0024		130	76 x 200	1.90	76 x 200
----------------------------------	----------	--	-----	----------	------	----------

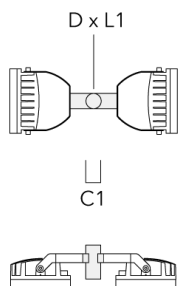

Description	Référence	A	C1	D x L1	Poids (kg)	D x S
TA1 traverse simple (Ø 76 x 200)	147-0023		130	76 x 200	1.50	76 x 200

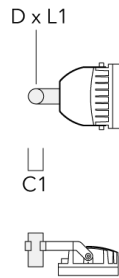

Collier pour mâts TS

Description	Référence	D1	Poids (kg)	D
TS1-2/M12 collier simple pour tube (Ø 102-114)	147-0526	102-114	1.50	102-114

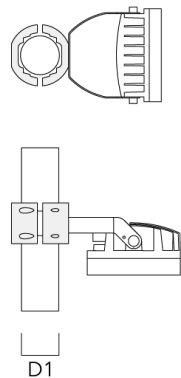

Description	Référence	D1	Poids (kg)	D
TS1-2/M12 collier simple pour tube (Ø 114-133)	147-0544	114-133	1.70	114-133

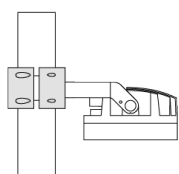
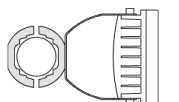

D1

TS1-2/M12 collier simple pour tube (Ø 76-89)	147-0543	76-89	1.40	76-89
-------------------------------------------------	----------	-------	------	-------

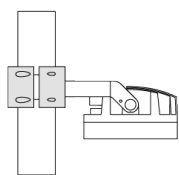
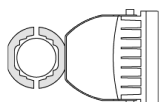

D1

FLC220 LED

Description	Référence	D1	Poids (kg)	D
TS2-2/M12 collier double pour tube (Ø 76-89)	147-0545	76-89	1.40	76-89

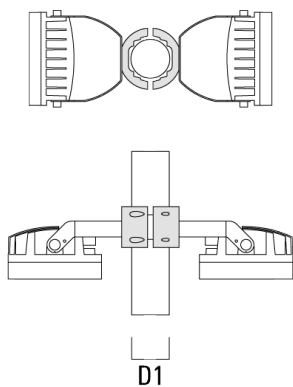

TS2-2/M12 collier double pour tube (Ø 114-133)	147-0546	114-133	1.60	114-133
---------------------------------------------------	----------	---------	------	---------

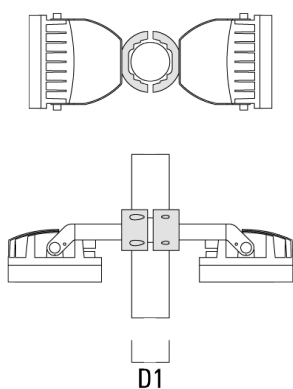

FLC220 LED

Description	Référence	D1	Poids (kg)	D
TS2-2/M12 collier double pour tube (Ø 102-114)	147-0527	102-114	1.50	102-114

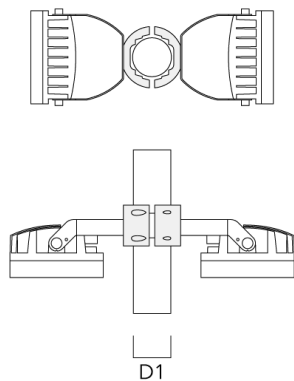

Collier pour mâts PC

Description	Référence	D1	Poids (kg)
PC2 76-89/60 collier double pour tube (Ø 76-89)	139-2703	76-89	1.00

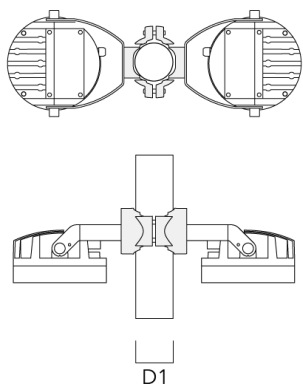

WE-EF Switzerland AG

Himmelrichstrasse 6, 6003 Luzern - Téléphone: +41 22 752 49 94

info.switzerland@we-ef.com - https://we-ef.com/ch_fr

Sous réserve de modifications techniques et d'erreurs. - Généré le 23/10/2024

Description	Référence	D1	Poids (kg)
PC1 76-89/60 collier simple (Ø 76-89)	139-2702	76-89	1.00



PC2 102-114/60 collier double pour tube (Ø 102-114)	139-2707	102-114	1.20
-----------------------------------------------------	----------	---------	------

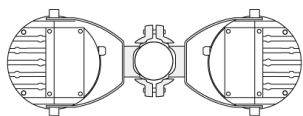

FLC220 LED

Description	Référence	D1	Poids (kg)
PC1 102-114/60 collier simple (Ø 102-114)	139-2706	102-114	1.20



PC2 114-133/60 collier double pour tube (Ø 114-133)	139-2709	114-133	1.40
-----------------------------------------------------	----------	---------	------

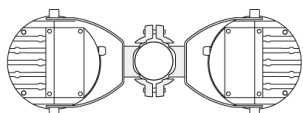

FLC220 LED

Description	Référence	D1	Poids (kg)
PC1 114-133/60 collier simple (Ø 114-133)	139-2708	114-133	1.40



PC2 82-109/60 collier double pour tube (Ø 82-109)	139-2705	82-109	1.10
---------------------------------------------------	----------	--------	------

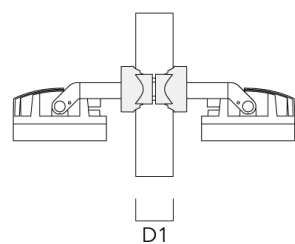

Description	Référence	D1	Poids (kg)
PC1 82-109/60 collier simple (Ø 82-109)	139-2704	82-109	1.10



Accessoires Optiques

Lentille rasante

Description	Référence	C1
IO-20-FLC220-LED	139-2035	146



Lentille ovalisante

Description	Référence	C1
IO-180-FLC220-LED	139-2036	146



Lentille e'largissante

WE-EF Switzerland AG

Himmelrichstrasse 6, 6003 Luzern - Téléphone: +41 22 752 49 94

info.switzerland@we-ef.com - https://we-ef.com/ch_fr

Sous réserve de modifications techniques et d'erreurs. - Généré le 23/10/2024

Description	Référence	C1
IO-360-FLC220-LED	139-2037	146

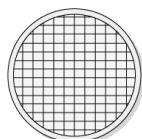

C1

Grille nid d'abeille

Description	Référence	C1
IW-FLC220-LED - [EE][EES]	139-2034	138

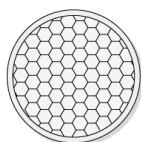

C1

Visière

WE-EF Switzerland AG

Himmelrichstrasse 6, 6003 Luzern - Téléphone: +41 22 752 49 94

info.switzerland@we-ef.com - https://we-ef.com/ch_fr

Sous réserve de modifications techniques et d'erreurs. - Généré le 23/10/2024

Description	Référence	A	C1
ES-FLC220-LED	139-1986	125	190

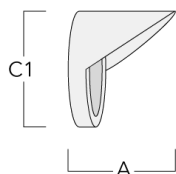

Canon anti-éblouissement

Description	Référence	A	C1
ET-FLC220-LED	139-1987	125	190

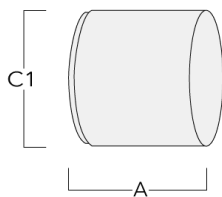

139-1999

FLC220 LED

we-ef

Control

R2C Ready to Connect

Description	Référence
R2C Ready to Connect (top)	430-0019

WE-EF Switzerland AG

Himmelrichstrasse 6, 6003 Luzern - Téléphone: +41 22 752 49 94

info.switzerland@we-ef.com - https://we-ef.com/ch_fr

Sous réserve de modifications techniques et d'erreurs. - Généré le 23/10/2024

139-1999

FLC220 LED

WE-EF Switzerland AG

Himmelrichstrasse 6, 6003 Luzern

Téléphone: +41 22 752 49 94

info.switzerland@we-ef.com

https://we-ef.com/ch_fr

Sous réserve de modifications techniques et d'erreurs.

Généré le 23/10/2024