



Description

IP66. Class I. IK07. Marine-grade, die-cast aluminium alloy. 5CE superior corrosion protection including PCS hardware. Safety glass lens. Silicone CCG® Controlled Compression Gasket.

Integral EC electronic converter in thermally-separated compartment. Advanced thermal management protects LEDs while optimising lumens output. CAD-optimised optics for superior illumination and glare control. OLC® One LED Concept.

For 2200 K version up to max. 1050mA available on request

| | |
|---------------------------|----------------------------------|
| Weight | 4.30 kg |
| Light distribution | symmetric, very narrow beam [EE] |
| Light source | LED-6/18W / 1050 mA - 3000 K |
| CRI | 80 |
| Power supply | EC |
| LEDs | 6 |
| Rated input power | 21 W |
| Nominal Lumen (lm) | |
| LED Lumen | 430 |
| Total Lumen | 2580 |
| Tj | 85 |
| Rated lumens (lm) | |
| LED Lumen | 385.4 |
| Total Lumen | 2312.6 |
| Ta | 25 |

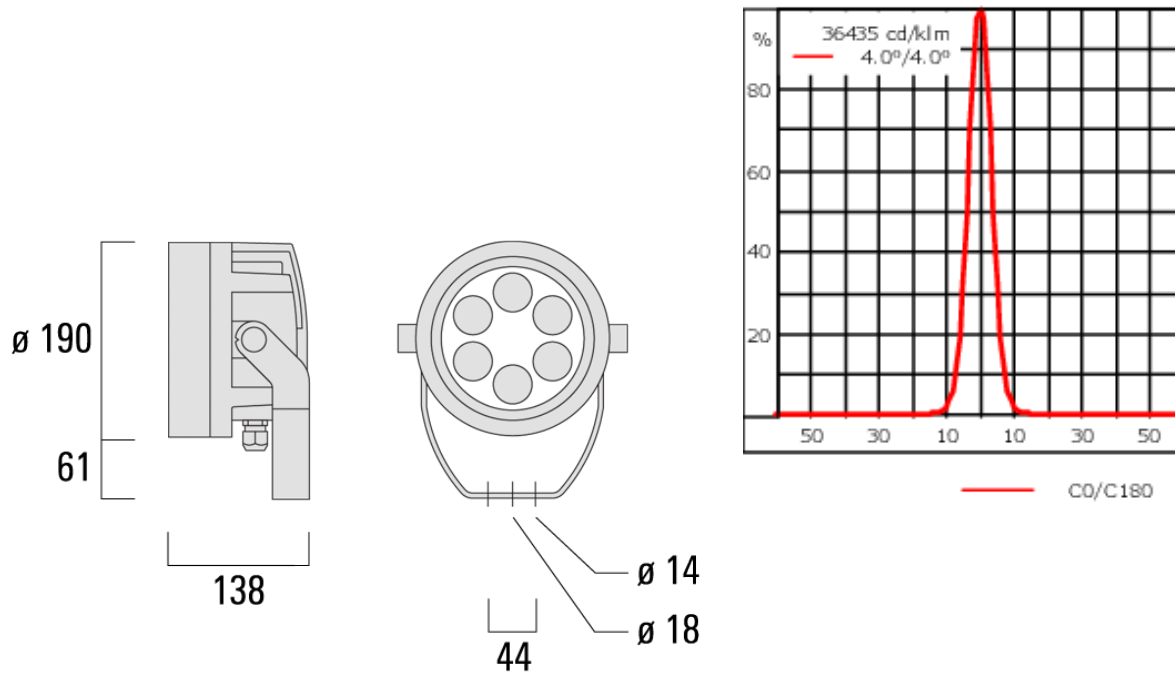

Specifications
Material description

| | |
|----------------------|---|
| Body | Marine-grade, die-cast aluminium alloy |
| Lens | Safety glass lens |
| Colours | <div style="display: flex; align-items: center;"> <div style="width: 20px; height: 15px; background-color: black; margin-right: 5px;"></div> RAL9004 Signal black </div> <div style="display: flex; align-items: center;"> <div style="width: 20px; height: 15px; background-color: grey; margin-right: 5px;"></div> RAL9007 Grey aluminium </div> <div style="display: flex; align-items: center;"> <div style="width: 20px; height: 15px; background-color: darkgrey; margin-right: 5px;"></div> RAL7016 Anthracite grey </div> <div style="display: flex; align-items: center;"> <div style="width: 20px; height: 15px; background-color: lightgrey; margin-right: 5px;"></div> RAL9016 Traffic white </div> |
| Gasket | Silicone CCG® Controlled Compression Gasket |
| Fasteners | PCS Polymer Coated Stainless Steel Hardware |
| Ingress protection | IP66 |
| Impact resistance | IK07 |
| Corrosion resistance | 5CE |
| Windage | 0.030 m ² |

Electrical description

| | |
|------------------|---|
| Power supply | 220-240V / 50-60 Hz |
| Driver / Ballast | Integral EC electronic converter in thermally-separated compartment |

Additional information

| | |
|----------|------------------------|
| Lifetime | Ta=25° L90B10 > 90000h |
|----------|------------------------|

Mounting Accessories

Short post

| Description | Part ID | D1 | D2 | H1 | M1 | Weight (kg) |
|--------------------|----------|-----|-----|-----|----|-------------|
| Short post EM1-M16 | 270-9038 | 160 | 130 | 203 | 9 | 2.10 |

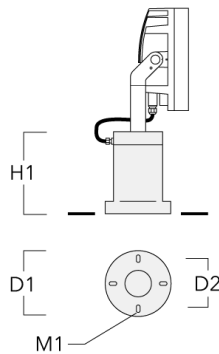

Floodlight mounting bracket TA

| Description | Part ID | A | C1 | D x L1 | Weight (kg) | D x S |
|--|----------|---|-----|-----------|-------------|-----------|
| TA1 Mounting bracket, single (Ø 108 x 200) | 147-0096 | | 130 | 108 x 200 | 7.50 | 108 x 200 |

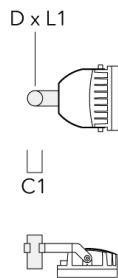

FLC220 LED

| Description | Part ID | A | C1 | D × L1 | Weight (kg) | D × S |
|--|----------|---|-----|-----------|-------------|-----------|
| TA2 Mounting bracket, double (Ø 108 x 200) | 147-0097 | | 130 | 108 x 200 | 7.50 | 108 x 200 |

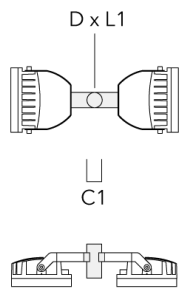

| | | | | | | |
|---|----------|------|-----|----------|-------|----------|
| TA3 Mounting bracket, triple (Ø 89 x 200) | 147-0025 | ±90° | 650 | 89 x 200 | 17.90 | 89 x 200 |
|---|----------|------|-----|----------|-------|----------|

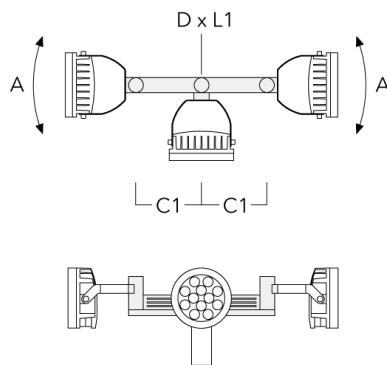

FLC220 LED

| Description | Part ID | A | C1 | D × L1 | Weight (kg) | D × S |
|--|----------|------|-----|-----------|-------------|-----------|
| TA3 Mounting bracket, triple (Ø 108 x 200) | 147-0098 | ±90° | 650 | 108 x 200 | 24.20 | 108 x 200 |

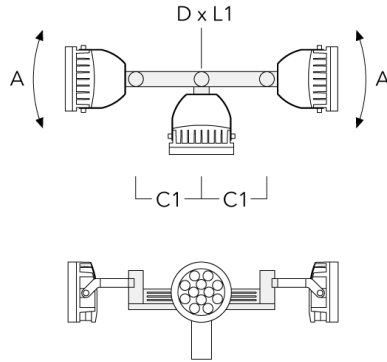

Planted root

| Description | Part ID | D1 | D2 | D3 | D4 | H1 | H2 | M1 | T1 | T2 | Weight (kg) |
|-------------------|-------------|-----|-----|----|----|-----|-----|----|-----|----------|-------------|
| Planted root ESV4 | 300-0461-AP | 150 | 130 | 60 | 89 | 400 | 350 | 8 | 200 | 50 x 100 | 3.85 |

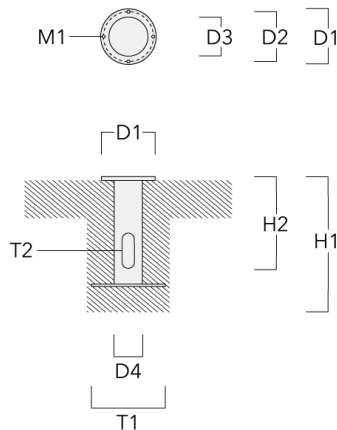

FLC220 LED

Pole clamp

| Description | Part ID | D1 | Weight (kg) | D |
|--|----------|---------|-------------|---------|
| TS2-2/M12 Pole clamp, double (Ø 102-114) | 147-0527 | 102-114 | 1.50 | 102-114 |

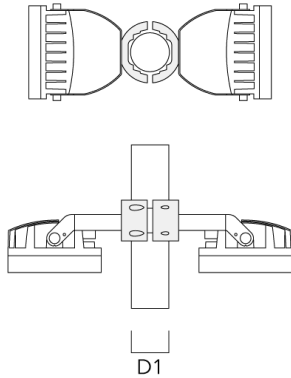

Spigot cap

| Description | Part ID | D1 | Weight (kg) |
|---------------------------------|----------|----------|-------------|
| Spigot Cap KF1-M16 (ø 60 x 100) | 310-9120 | 60 x 100 | 1.40 |

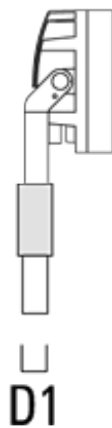

FLC220 LED

| Description | Part ID | D1 | Weight (kg) |
|---------------------------------|----------|----------|-------------|
| Spigot Cap KF1-M16 (ø 76 x 100) | 310-9121 | 76 x 100 | 2.2 |

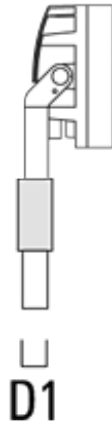

Pole clamp SP - Tilttable

| Description | Part ID | D1 | Weight (kg) | D |
|--------------------------------------|----------|-------|-------------|-------|
| Pole clamp SP1-M16, single (ø 76-89) | 146-0242 | 76-89 | 1.30 | 76-89 |

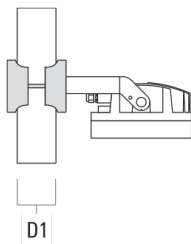

FLC220 LED

| Description | Part ID | D1 | Weight (kg) | D |
|--------------------------------------|----------|-------|-------------|---|
| Pole clamp SP2-M16, double (Ø 76-89) | 146-0244 | 76-89 | 1.50 | |

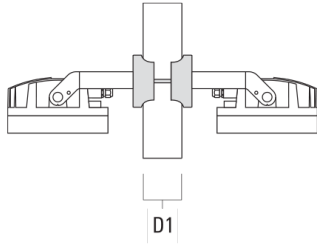

| | | | | |
|--------------------------------------|----------|-------|------|--|
| Pole clamp SP1-M16, single (Ø 38-60) | 146-0241 | 38-60 | 1.30 | |
|--------------------------------------|----------|-------|------|--|

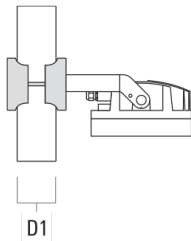

| | | | | |
|--------------------------------------|----------|-------|------|--|
| Pole clamp SP2-M16, double (Ø 38-60) | 146-0243 | 38-60 | 1.50 | |
|--------------------------------------|----------|-------|------|--|

Junction box

| Description | Part ID | Additional information | A | B | C1 | Weight (kg) |
|--|----------|--|-----|-----|----|-------------|
| Junction box JB20 - Cable side entries | 310-9013 | Junction boxes are made from marine-grade, die-cast aluminium alloy. IK10. IP66. For side entries and suitable to be used with cable glands. | 180 | 143 | 51 | 1.02 |

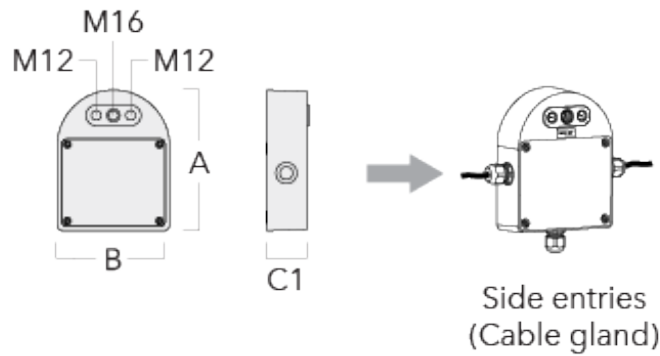

| | | | | | | |
|--|----------|--|-----|-----|----|------|
| Junction box JB20 - Conduit side entries | 310-9014 | Junction boxes are made from marine-grade, die-cast aluminium alloy. IK10. IP66. For side entries and suitable to be used with conduits. | 180 | 143 | 51 | 1.02 |
|--|----------|--|-----|-----|----|------|

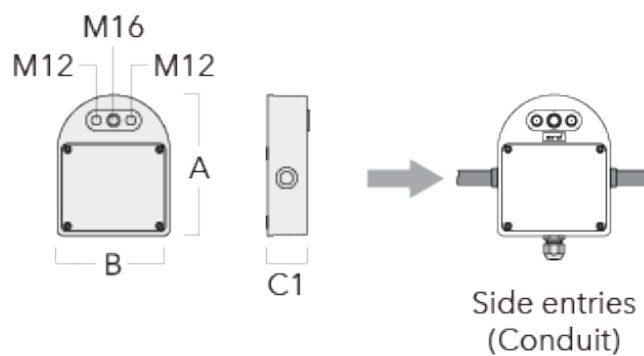

FLC220 LED

| Description | Part ID | Additional information | A | B | C1 | Weight (kg) |
|----------------------------------|----------|--|-----|-----|----|-------------|
| Junction box JB20 - Wall entries | 310-9018 | Junction boxes are made from marine-grade, die-cast aluminium alloy. IK10. IP66. For wall entries. | 180 | 143 | 51 | 1.02 |

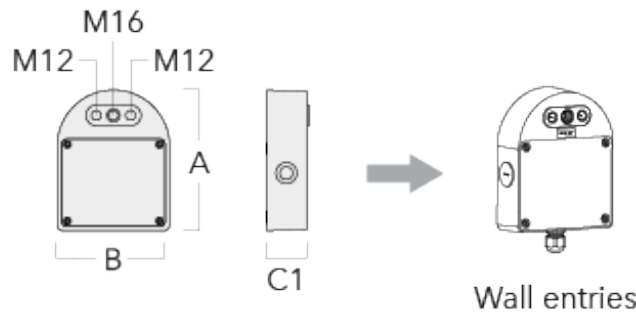

Pole clamp PC - Rotatable

| Description | Part ID | D1 | Weight (kg) |
|---|----------|-------|-------------|
| PC2 76-89/60 Pole clamp, double (Ø 76-89) | 139-2703 | 76-89 | 1.00 |

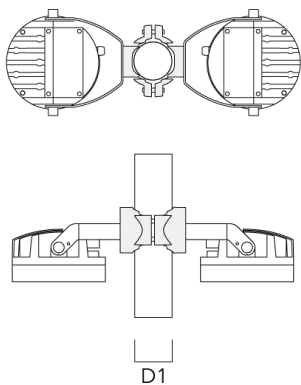

FLC220 LED

| Description | Part ID | D1 | Weight (kg) |
|---|----------|-------|-------------|
| PC1 76-89/60 Pole clamp, single (Ø 76-89) | 139-2702 | 76-89 | 1.00 |

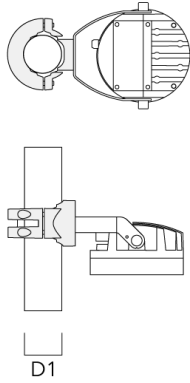

| | | | |
|---|----------|---------|------|
| PC2 102-114/60 Pole clamp, double (Ø 102-114) | 139-2707 | 102-114 | 1.20 |
|---|----------|---------|------|

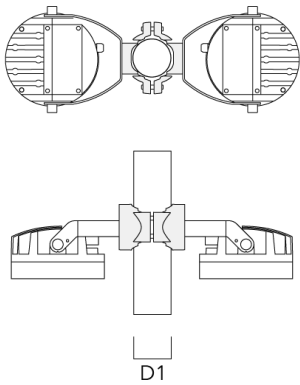

FLC220 LED

| Description | Part ID | D1 | Weight (kg) |
|--|----------|---------|-------------|
| PC1 102-114/60 Pole clamp, single (Ø 102-114) | 139-2706 | 102-114 | 1.20 |

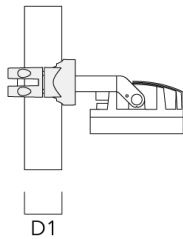
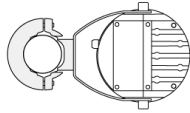

| | | | |
|--|----------|---------|------|
| PC2 114-133/60 Pole clamp, double (Ø 114-133) | 139-2709 | 114-133 | 1.40 |
|--|----------|---------|------|

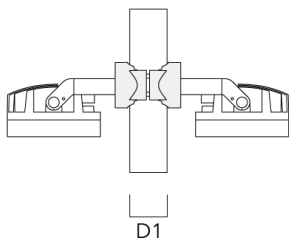
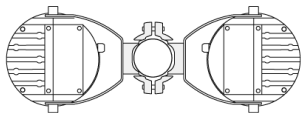

FLC220 LED

| Description | Part ID | D1 | Weight (kg) |
|--|----------|---------|-------------|
| PC1 114-133/60 Pole clamp, single (Ø 114-133) | 139-2708 | 114-133 | 1.40 |

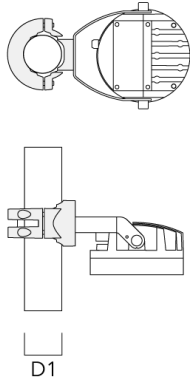

| | | | |
|--|----------|--------|------|
| PC2 82-109/60 Pole camp, double (Ø 82-109) | 139-2705 | 82-109 | 1.10 |
|--|----------|--------|------|

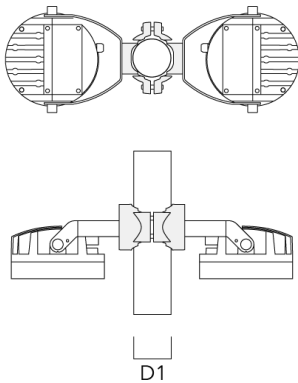

FLC220 LED

| Description | Part ID | D1 | Weight (kg) |
|--|----------|--------|-------------|
| PC1 82-109/60 Pole camp, single (Ø 82-109) | 139-2704 | 82-109 | 1.10 |

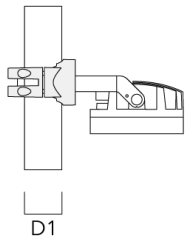
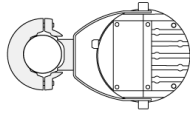

Control

1-10 V analogue dimming interface

| Description | Part ID | C |
|-----------------------------------|----------|----|
| 1-10 V analogue dimming interface | 430-0011 | 90 |

R2C Ready to Connect

| Description | Part ID |
|----------------------------|----------|
| R2C Ready to Connect (top) | 430-0019 |

DALI interface

| Description | Part ID | Additional information |
|----------------|----------|--|
| DALI interface | 430-0013 | DALI variant. The luminaire is equipped with a DT6 Dali driver (Dali 2.0). |

Dali 2.0

- Application controllers and Input devices defined
- Single-masters and multi-masters allowed
- Event priorities defined
- Separate addressing & grouping from control gear

Note: Mixing Dali 1 and Dali 2.0 drivers can cause problems because the addressing and the command scope has changed!

Optical Accessories

Wallwash lens

| Description | Part ID | C1 |
|---------------------|-------------|-----|
| Wallwash lens IO-20 | 139-2035-AP | 146 |

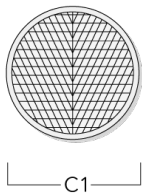

Linear spread lens

| Description | Part ID | C1 |
|---------------------------|----------|-----|
| Linear spread lens IO-180 | 139-2036 | 146 |

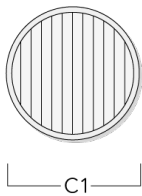

FLC220 LED

Flood lens

| Description | Part ID | C1 |
|-------------------|----------|-----|
| Flood lens IO-360 | 139-2037 | 146 |

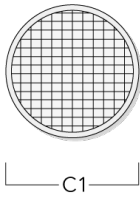

Honeycomb louvre

| Description | Part ID | C1 |
|---------------------|----------|-----|
| Honeycomb louvre IW | 139-2034 | 138 |

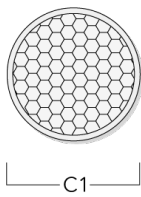

Glare shield

| Description | Part ID | A | C1 |
|-----------------|----------|-----|-----|
| Glare shield ES | 139-1986 | 125 | 190 |

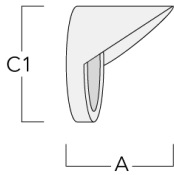

Snoot

| Description | Part ID | A | C1 |
|-------------|----------|-----|-----|
| Snoot ET | 139-1987 | 125 | 190 |

