

161-5864

we-ef

FLB141 LED #2 SHORT POST MOUNT Asymmetric



Description

IP66. Class I. IK08. Marine-grade, die-cast aluminum alloy. 5CE superior corrosion protection including PCS hardware. Silicone CCG® Controlled Compression Gasket. Safety glass lens, hinged. CAD-optimized optics for superior illumination and glare control. Integral driver. OLC® One LED Concept. Advanced thermal management protects LEDs while optimizing lumens output. 0-10V Dimming comes standard with luminaire. Luminaire is factory-sealed and does not need to be opened during installation.

Mounting accessories to be ordered separately.

Specify product with 7 Digit product code - Finish Color. Accessories, such as mounting, optical, and electrical, must be specified separately.

Example: XXX-XXXX-9004 (Black)
+ XXX-XXXX (Accessory 1)

Weight	8.59 lb
Light distribution	[P65] Type II Medium
Light source	LED-6/18W / 1050 mA - 3000 K
CRI	80
Power supply	electronic gear
LEDs	6
Rated input power	21 W
Nominal Lumen (lm)	
LED Lumen	430
Total Lumen	2580
Tj	85
Delivered lumens (lm)	
LED Lumen	253.9
Total Lumen	1523.7
Ta	25

WE-EF LIGHTING USA, LLC

410-D Keystone Drive, 15086 Warrendale, PA 15086 - Phone: +1 724 742 0030
customersupport.usa@we-ef.com - <https://we-ef.com/us>
Subject to technical changes and errors. - Generated on 08/16/2025

161-5864

we-ef

FLB141 LED #2 SHORT POST MOUNT Asymmetric

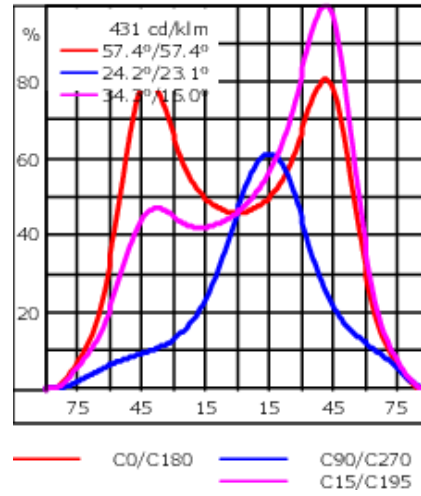
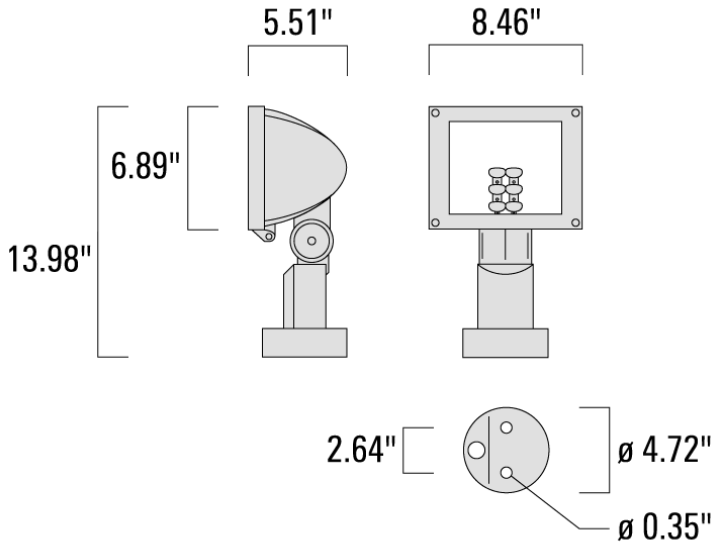

Specifications

Material description

Body	Marine-grade, die-cast aluminium alloy
Lens	Safety glass
Colors	<ul style="list-style-type: none"> RAL9004 Black RAL9007 Grey Metallic RAL9016 White RAL8019 Dark Bronze
Gasket	Silicone CCG® Controlled Compression Gasket
Fasteners	PCS hardware
Ingress protection	IP66
Impact resistance	IK08
Corrosion resistance	5CE

WE-EF LIGHTING USA, LLC

410-D Keystone Drive, 15086 Warrendale, PA 15086 - Phone: +1 724 742 0030

customersupport.usa@we-ef.com - <https://we-ef.com/us>

Subject to technical changes and errors. - Generated on 08/16/2025

161-5864

we-ef

FLB141 LED #2 SHORT POST MOUNT Asymmetric

Electrical description

Power supply	Integral [ECG] electronic driver 120V-277V. 0-10V dimmable, to be specified with order.
Driver / Ballast	Integral EC electronic converter in thermally-separated compartment

Additional information

Listings	UL 1598, CSA C22.2 #250.0 (Intertek)
----------	--------------------------------------

WE-EF LIGHTING USA, LLC

410-D Keystone Drive, 15086 Warrendale, PA 15086 - Phone: +1 724 742 0030
customersupport.usa@we-ef.com - <https://we-ef.com/us>
Subject to technical changes and errors. - Generated on 08/16/2025

161-5864

we-ef

FLB141 LED #2 SHORT POST MOUNT Asymmetric

Optical Accessories

Wire guard

Description	Part ID	C1	H1
Wire guard EG	161-9118	7.13	6.02

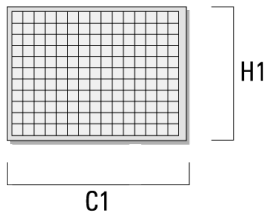

WE-EF LIGHTING USA, LLC

410-D Keystone Drive, 15086 Warrendale, PA 15086 - Phone: +1 724 742 0030
customersupport.usa@we-ef.com - <https://we-ef.com/us>

Subject to technical changes and errors. - Generated on 08/16/2025

FLB141 LED #2 SHORT POST MOUNT Asymmetric

Barn doors

Description	Part ID	A	H1
Barn doors ED	161-9119	9.65	5.2

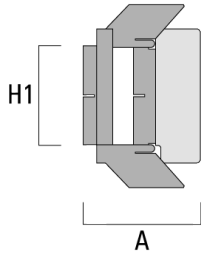

Glare shield

Description	Part ID	A	H1
Glare shield ES	161-9121	6.5	5.20

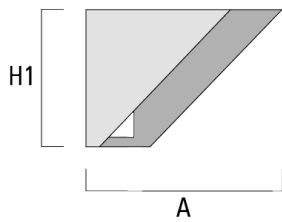

WE-EF LIGHTING USA, LLC

410-D Keystone Drive, 15086 Warrendale, PA 15086 - Phone: +1 724 742 0030
 customersupport.usa@we-ef.com - <https://we-ef.com/us>
 Subject to technical changes and errors. - Generated on 08/16/2025

161-5864

we-ef

FLB141 LED #2 SHORT POST MOUNT Asymmetric

Honeycomb louvre

Description	Part ID	C1
Honeycomb Louvre IW	146-0625	4.33



WE-EF LIGHTING USA, LLC

410-D Keystone Drive, 15086 Warrendale, PA 15086 - Phone: +1 724 742 0030
customersupport.usa@we-ef.com - <https://we-ef.com/us>
Subject to technical changes and errors. - Generated on 08/16/2025

161-5864

we-ef

FLB141 LED #2 SHORT POST MOUNT Asymmetric

Mounting Accessories

Planted root

Description	Part ID	D1	D2	D3	D4	H1	H2	M1	Weight (lb)
Planted root ESV4	300-0461	5.71	5.12	2.36	3.50	15.75	13.78	.31	8.44

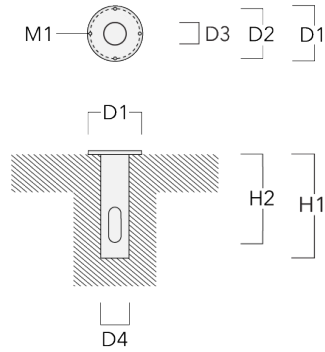

WE-EF LIGHTING USA, LLC

410-D Keystone Drive, 15086 Warrendale, PA 15086 - Phone: +1 724 742 0030
customersupport.usa@we-ef.com - <https://we-ef.com/us>
Subject to technical changes and errors. - Generated on 08/16/2025

161-5864

we-ef

FLB141 LED #2 SHORT POST MOUNT Asymmetric

Pipe clamp SP

Description	Part ID	D1	Weight (lb)	D
SP1-2/M8 Pipe clamp, single (Ø 1.5"-2.36")	146-0245	38-60	1.10	38-66

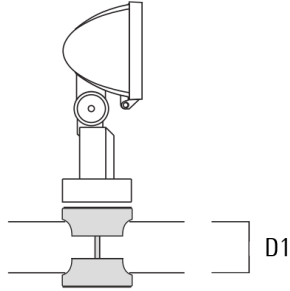

SP1-2/M8 Pipe clamp, single (Ø 3"-3.5")	146-0246	76-89	1.10	76-89
---	----------	-------	------	-------

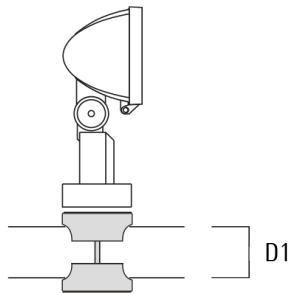

WE-EF LIGHTING USA, LLC

410-D Keystone Drive, 15086 Warrendale, PA 15086 - Phone: +1 724 742 0030
customersupport.usa@we-ef.com - <https://we-ef.com/us>
Subject to technical changes and errors. - Generated on 08/16/2025

161-5864

we-ef

FLB141 LED #2 SHORT POST MOUNT Asymmetric

Description	Part ID	D1	Weight (lb)	D
SP2-2/M8 Pipe clamp, double (Ø 1.5"-2.36")	146-0247	1.50"-2.36"	2.20 lbs	38-66

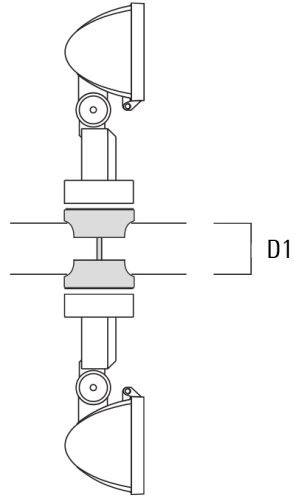

SP2-2/M8 Pipe clamp, double (Ø 3"-3.5")	146-0248	3.0"-3.5"	2.65 lbs	76-89
---	----------	-----------	----------	-------

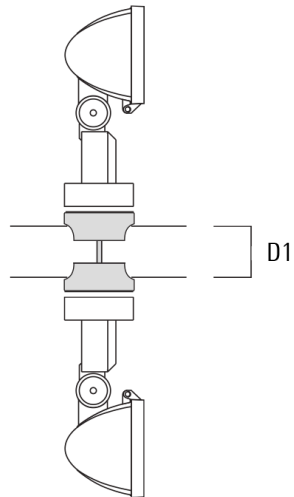

WE-EF LIGHTING USA, LLC

410-D Keystone Drive, 15086 Warrendale, PA 15086 - Phone: +1 724 742 0030
customersupport.usa@we-ef.com - <https://we-ef.com/us>

Subject to technical changes and errors. - Generated on 08/16/2025

FLB141 LED #2 SHORT POST MOUNT Asymmetric

Junction box JB1

Description	Part ID	D1	D2	M1	Weight (lb)
JB1 Junction box	310-9000	5.31	2.64	0.35	1.60

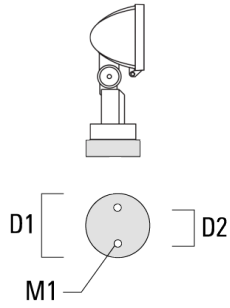

Short post EM

Description	Part ID	M1	Weight (lb)
Short post EM1-2/M8 for FLB141	146-0253	.35	1.70

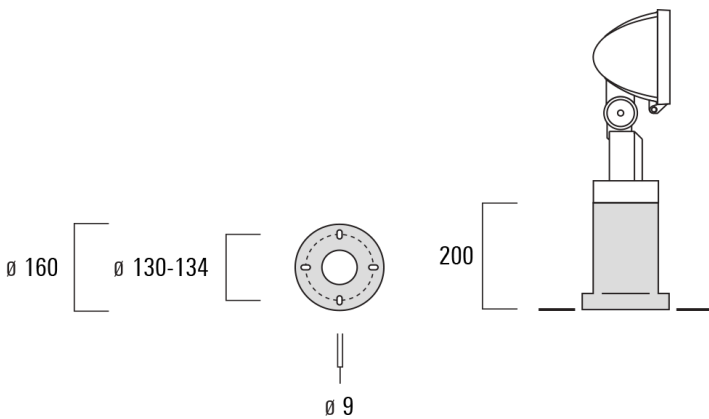

WE-EF LIGHTING USA, LLC

410-D Keystone Drive, 15086 Warrendale, PA 15086 - Phone: +1 724 742 0030
 customersupport.usa@we-ef.com - <https://we-ef.com/us>
 Subject to technical changes and errors. - Generated on 08/16/2025