



Description

Changement de couleurs RGBW/RGBA. IP66. Classe I. IK07. Corps en fonte d'aluminium. Visserie inox avec traitement PCS. Protection contre la corrosion 5CE. Joint silicone. Verre de sécurité. LED contrôlables par système DMX.

Technologie sans fil DMX Wireless disponible.

Poids	4.30 kg
Distribution de la lumière	faisceau ovalisante, intensif [E]
Source lumineuse	LED-6/24W - RGBW/4K
IRC	20/80
Alimentation électrique	ballast électronique
LEDs	6
Rated input power	29 W
Flux lumineux nominal (lm)	
LED Lumen	340
Total Lumen	2040
Tj	85
Rated lumens (lm)	
LED Lumen	242.9
Total Lumen	1457.6
Ta	25

WE-EF Switzerland AG

Himmelrichstrasse 6, 6003 Luzern - Téléphone: +41 22 752 49 94

info.switzerland@we-ef.com - https://we-ef.com/ch_fr

Sous réserve de modifications techniques et d'erreurs. - Généré le 10/03/2025

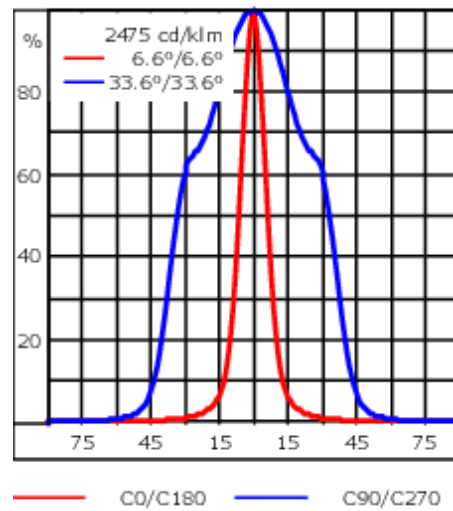
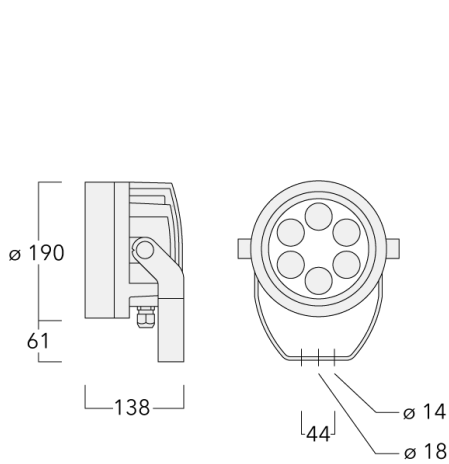

Spécifications

Description du matériel

Corps	Corps en fonte d'aluminium, visserie inox avec traitement PCS
Lentille	Safety glass lens
Couleurs	<div style="display: flex; align-items: center; gap: 10px;"> <div style="width: 20px; height: 15px; background-color: black; margin-right: 5px;"></div> RAL9004 Noir de sécurité </div> <div style="display: flex; align-items: center; gap: 10px;"> <div style="width: 20px; height: 15px; background-color: gray; margin-right: 5px;"></div> RAL9007 Aluminium gris </div> <div style="display: flex; align-items: center; gap: 10px;"> <div style="width: 20px; height: 15px; background-color: darkgray; margin-right: 5px;"></div> RAL7016 Gris anthracite </div> <div style="display: flex; align-items: center; gap: 10px;"> <div style="width: 20px; height: 15px; background-color: lightgray; margin-right: 5px;"></div> RAL9016 Blanc signalisation </div>
Joint	Silicone CCG® Controlled Compression Gasket
Visserie	PCS Inox avec recouvrement polymère
IP	IP66
IK	IK07
Protection contre la corrosion	5CE
Surface exposée au vent	0.030 m ²

Description électrique

Alimentation électrique	220-240V / 50-60 Hz
Driver	DMX
Power factor	> 0.9
Protection contre les surtensions	1/2 kV (optional SP10)

Informations complémentaires

Durée de vie	Ta=25° L90B10 > 90000h
Classe d'efficacité énergétique	G

Accessoires d'installation

Traverse pour mâts

Description	Référence	A	C1	D x L1	Poids (kg)	D x S
TA1 traverse simple (Ø 108 x 200)	147-0096		130	108 x 200	7.50	108 x 200

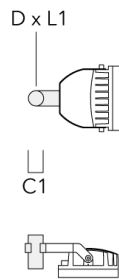

TA2 traverse double (Ø 108 x 200)	147-0097		130	108 x 200	7.50	108 x 200
-----------------------------------	----------	--	-----	-----------	------	-----------

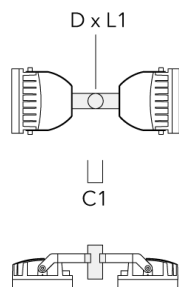

FLC220-CC LED

Description	Référence	A	C1	D x L1	Poids (kg)	D x S
TA3 traverse triple orientable (Ø 89 x 200)	147-0025	±90°	650	89 x 200	17.90	89 x 200



TA3 traverse triple orientable (Ø 108 x 200)	147-0098	±90°	650	108 x 200	24.20	108 x 200
--	----------	------	-----	-----------	-------	-----------

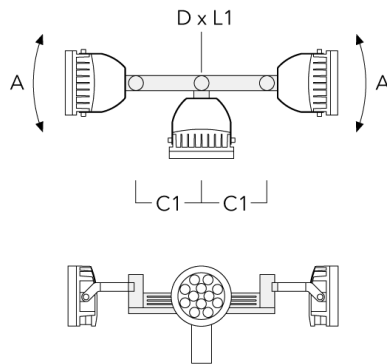

FLC220-CC LED

Description	Référence	A	C1	D × L1	Poids (kg)	D × S
TA2 traverse double (Ø 76 x 200)	147-0024		130	76 x 200	1.90	76 x 200

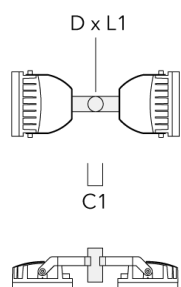

TA1 traverse simple (Ø 76 x 200)	147-0023		130	76 x 200	1.50	76 x 200
----------------------------------	----------	--	-----	----------	------	----------

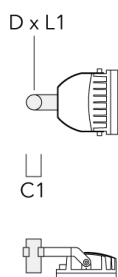

FLC220-CC LED

Collier pour mâts TS

Description	Référence	D1	Poids (kg)	D
TS1-2/M12 collier simple pour tube (Ø 102-114)	147-0526	102-114	1.50	102-114

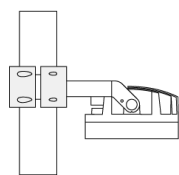
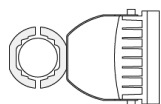

D1

TS1-2/M12 collier simple pour tube (Ø 114-133)	147-0544	114-133	1.70	114-133
--	----------	---------	------	---------

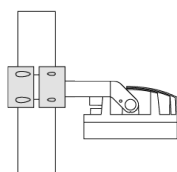
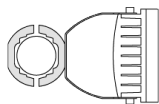

D1

FLC220-CC LED

Description	Référence	D1	Poids (kg)	D
TS1-2/M12 collier simple pour tube (Ø 76-89)	147-0543	76-89	1.40	76-89

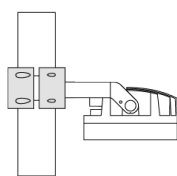
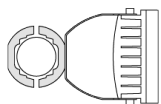

D1

TS2-2/M12 collier double pour tube (Ø 76-89)	147-0545	76-89	1.40	76-89
---	----------	-------	------	-------

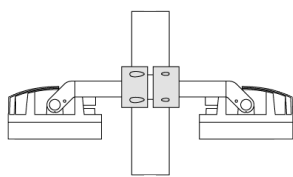
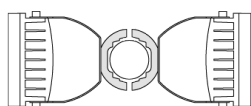

D1

FLC220-CC LED

Description	Référence	D1	Poids (kg)	D
TS2-2/M12 collier double pour tube (Ø 114-133)	147-0546	114-133	1.60	114-133

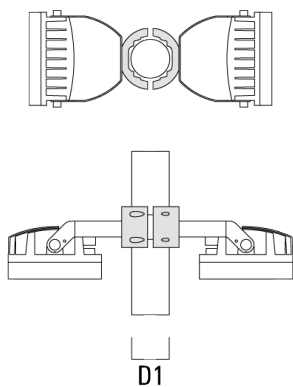

TS2-2/M12 collier double pour tube (Ø 102-114)	147-0527	102-114	1.50	102-114
---	----------	---------	------	---------

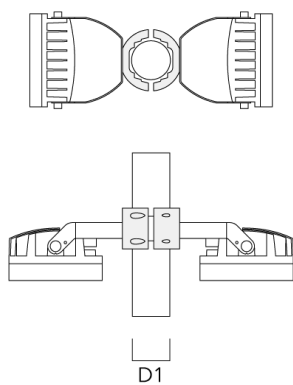

FLC220-CC LED

Collier pour mâts PC

Description	Référence	D1	Poids (kg)
PC2 76-89/60 collier double pour tube (Ø 76-89)	139-2703	76-89	1.00

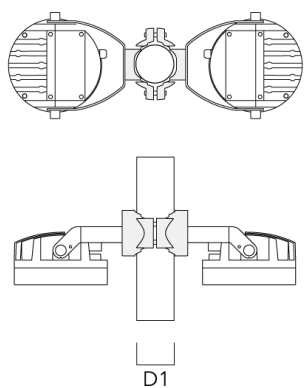

PC1 76-89/60 collier simple (Ø 76-89)	139-2702	76-89	1.00
---------------------------------------	----------	-------	------

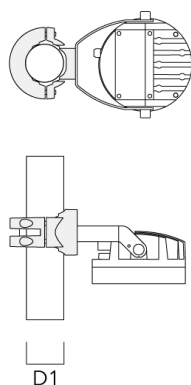

FLC220-CC LED

Description	Référence	D1	Poids (kg)
PC2 102-114/60 collier double pour tube (Ø 102-114)	139-2707	102-114	1.20

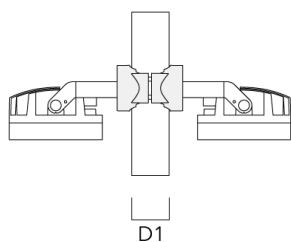
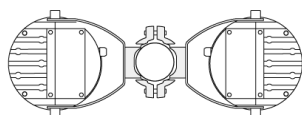

PC1 102-114/60 collier simple (Ø 102-114)	139-2706	102-114	1.20
---	----------	---------	------

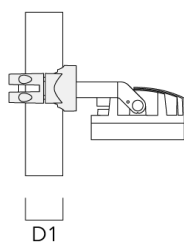
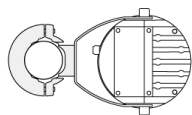

FLC220-CC LED

Description	Référence	D1	Poids (kg)
PC2 114-133/60 collier double pour tube (Ø 114-133)	139-2709	114-133	1.40

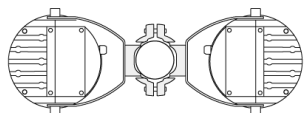

PC1 114-133/60 collier simple (Ø 114-133)	139-2708	114-133	1.40
---	----------	---------	------



FLC220-CC LED

Description	Référence	D1	Poids (kg)
PC2 82-109/60 collier double pour tube (Ø 82-109)	139-2705	82-109	1.10

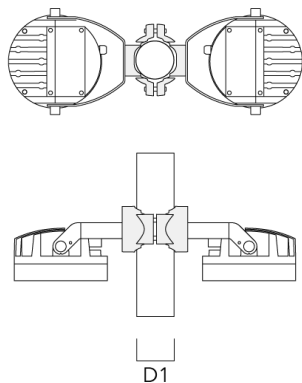

PC1 82-109/60 collier simple (Ø 82-109)	139-2704	82-109	1.10
---	----------	--------	------

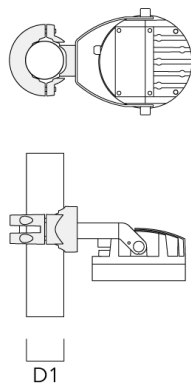

FLC220-CC LED

Control

DMX Controller

Description	Référence
DMX Controller	400-0469

DMX Controller (smart)

Description	Référence	Informations complémentaires
DMX Controller (smart)	400-0470	IP20. The Touch Panel is an intuitive and easy-to-use keypad for one DMX universe. It can store up to 36 scenes; alternatively, via



FLC220-CC LED

DMX Controller - RDM ready

Description	Référence
DMX Controller - RDM ready	400-0471



DMX Splitter

Description	Référence
DMX Splitter	400-0473



FLC220-CC LED

DMX Booster Box

Description	Référence
DMX Booster Box	400-0474



DMX Motion Sensor

Description	Référence
DMX Motion Sensor	400-0478



WE-EF Switzerland AG

Himmelrichstrasse 6, 6003 Luzern - Téléphone: +41 22 752 49 94

info.switzerland@we-ef.com - https://we-ef.com/ch_fr

Sous réserve de modifications techniques et d'erreurs. - Généré le 10/03/2025

FLC220-CC LED

DMX Termination Plug

Description	Référence
DMX Termination Plug	400-0475



DMX Plug and Socket

Description	Référence
DMX Plug and Socket	400-0479



DMX Combination Cable

Description	Référence
DMX Combination Cable	400-0480



DMX Wireless Repeater

Description	Référence
DMX Wireless Repeater	400-0477



FLC220-CC LED

DMX Wireless Transceiver

Description	Référence
DMX Wireless Transceiver	400-0476



DMX Controller (smart) - RDM ready

Description	Référence
DMX Controller (smart) - RDM ready	400-0472



DMX Wireless Antenna

Description	Référence
Antenne RF 5dB	430-0036

WE-EF Switzerland AG

Himmelrichstrasse 6, 6003 Luzern - Téléphone: +41 22 752 49 94

info.switzerland@we-ef.com - https://we-ef.com/ch_fr

Sous réserve de modifications techniques et d'erreurs. - Généré le 10/03/2025

Description	Référence
Antenne RF1.8 dB	430-0018

Accessoires Optiques**Visière**

Description	Référence	A	C1
ES-FLC220-LED	139-1986	125	190

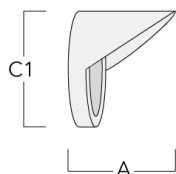
**Canon anti-éblouissement**

Description	Référence	A	C1
ET-FLC220-LED	139-1987	125	190

