



Description

RGBW/RGBA Colour Changer. IP66, Class I. Class II on request. IK07. Marine-grade, die-cast aluminium alloy. 5CE superior corrosion protection including PCS hardware. Silicone CCG® Controlled Compression Gasket. Safety glass lens. One cable gland. Second gland for through-wiring on request. Integral EC electronic converter, thermally separated. CAD-optimised optics for superior illumination and glare control. OLC® One LED Concept. Factory-installed LED circuit board with WE-EF Colour Boost Technology. With Colour Boost the targeted and selective control of individual channels or colours means that a higher power of the LEDs can be accessed than in total when all colours are simultaneously operated. The light output is thus maximized by targeted control of individual channels/colours.

DMX interface. For the M20 cable gland for network- and DMX-connection, WE-EF recommends a multi-core cable for DMX and power, "Power PUR-SR 3x1,5 + DMX".

| | |
|--------------------|-------------------|
| Weight | 13.80 kg |
| Light distribution | wallwash |
| Light source | LED-24/96W - RGBA |
| CRI | 20 |
| Power supply | EC |
| LEDs | 24 |
| Rated input power | 100 W |

Nominal Lumen (lm)

| | |
|-------------|------|
| LED Lumen | 275 |
| Total Lumen | 6600 |
| Tj | 85 |

Rated lumens (lm)

| | |
|-------------|--------|
| LED Lumen | 175.2 |
| Total Lumen | 4204.4 |
| Ta | 25 |

FLC240-CC LED

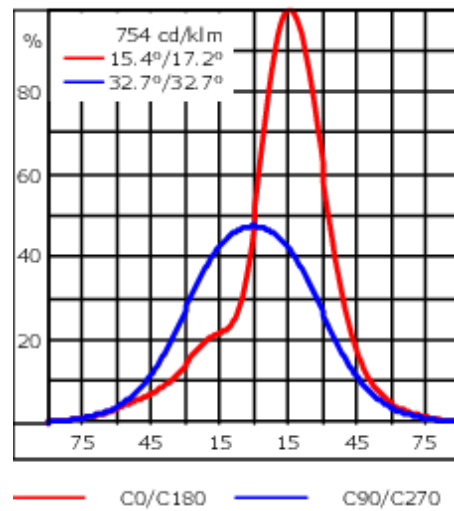
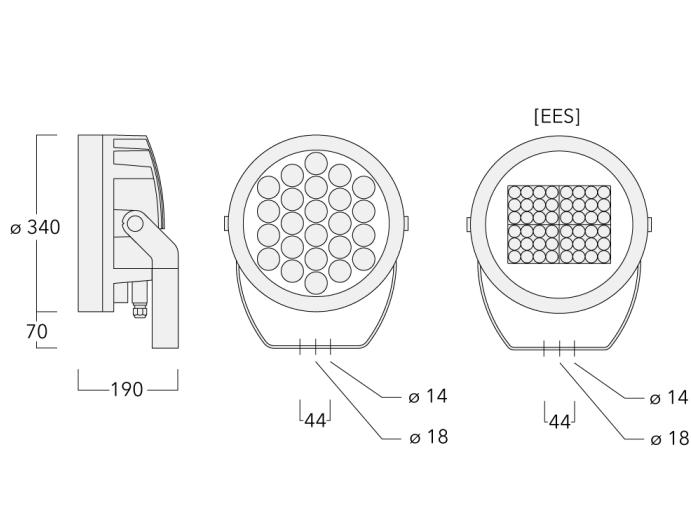

Specifications

Material description

| | |
|----------------------|---|
| Body | Marine-grade, die-cast aluminium alloy |
| Lens | Safety glass lens |
| Colours | <ul style="list-style-type: none"> RAL9004 Signal black RAL9006 White aluminium RAL9007 Grey aluminium RAL7016 Anthracite grey RAL9016 Traffic white |
| Gasket | Silicone CCG® Controlled Compression Gasket |
| Fasteners | PCS Polymer Coated Stainless Steel Hardware |
| Ingress protection | IP66 |
| Impact resistance | IK07 |
| Corrosion resistance | 5CE |
| Windage | 0.090 m ² |

Electrical description

| | |
|------------------|------------------------|
| Power supply | 220-240V / 50-60 Hz |
| Driver / Ballast | DMX |
| Power factor | > 0.9 |
| Surge protection | 1/2 kV (optional SP10) |

Additional information

| | |
|----------|------------------------|
| Lifetime | Ta=25° L90B10 > 90000h |
|----------|------------------------|

WE-EF LEUCHTEN GmbH

Töpinger Straße 16, 29646 Bispingen, Germany - Phone: +49 5194 909-0

info@we-ef.com - <https://we-ef.com>

Subject to technical changes and errors. - Generated on 10/03/2025

Mounting Accessories

Floodlight mounting bracket TA

| Description | Part ID | A | C1 | D x L1 | Weight (kg) | D x S |
|--|----------|---|-----|----------|-------------|----------|
| TA1 Mounting bracket, single* (Ø 76 x 200) | 147-0023 | | 130 | 76 x 200 | 1.90 | 76 x 200 |

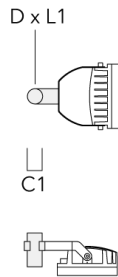

| | | | | | | |
|--|----------|--|-----|----------|------|----------|
| TA2 Mounting bracket, double* (Ø 76 x 200) | 147-0024 | | 130 | 76 x 200 | 1.90 | 76 x 200 |
|--|----------|--|-----|----------|------|----------|

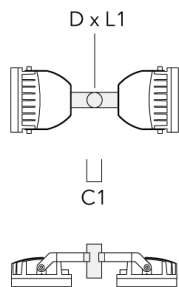

FLC240-CC LED

| Description | Part ID | A | C1 | D x L1 | Weight (kg) | D x S |
|---|----------|------|-----|----------|-------------|----------|
| TA2-L Mounting bracket, double (Ø 76 x 200) | 147-0105 | ±90° | 420 | 76 x 200 | 16.10 | 76 x 200 |

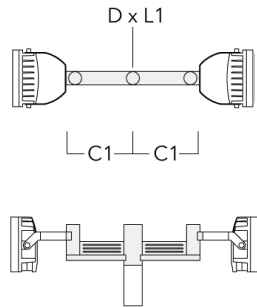

| | | | | | | |
|---|----------|------|-----|----------|-------|----------|
| TA3 Mounting bracket, triple (Ø 89 x 200) | 147-0025 | ±90° | 650 | 89 x 200 | 17.90 | 89 x 200 |
|---|----------|------|-----|----------|-------|----------|

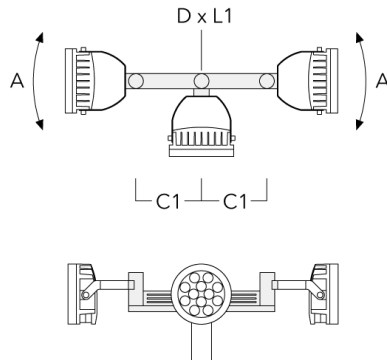

FLC240-CC LED

| Description | Part ID | A | C1 | D × L1 | Weight (kg) | D × S |
|---|----------|------|-----|----------|-------------|----------|
| TA4 Mounting bracket, quad (Ø 89 x 200) | 147-0099 | ±90° | 650 | 89 x 200 | 20.80 | 89 x 200 |



| | | | | | | |
|--|----------|--|-----|-----------|------|-----------|
| TA1 Mounting bracket, single (Ø 108 x 200) | 147-0096 | | 130 | 108 x 200 | 7.50 | 108 x 200 |
|--|----------|--|-----|-----------|------|-----------|

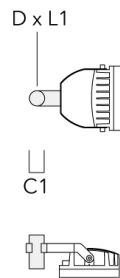

FLC240-CC LED

| Description | Part ID | A | C1 | D × L1 | Weight (kg) | D × S |
|--|----------|---|-----|-----------|-------------|-----------|
| TA2 Mounting bracket, double (Ø 108 x 200) | 147-0097 | | 130 | 108 x 200 | 7.50 | 108 x 200 |

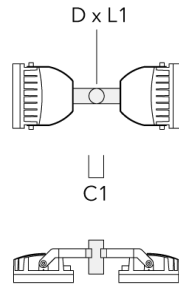

| | | | | | | |
|--|----------|------|-----|-----------|-------|-----------|
| TA2-L Mounting bracket, double (Ø 108 x 200) | 147-0148 | ±90° | 420 | 108 x 200 | 20.20 | 108 x 200 |
|--|----------|------|-----|-----------|-------|-----------|

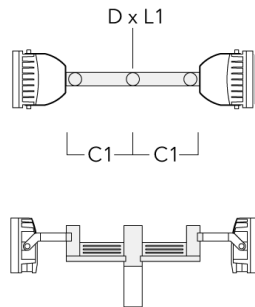

FLC240-CC LED

| Description | Part ID | A | C1 | D x L1 | Weight (kg) | D x S |
|--|----------|------|-----|-----------|-------------|-----------|
| TA3 Mounting bracket, triple (Ø 108 x 200) | 147-0098 | ±90° | 650 | 108 x 200 | 24.20 | 108 x 200 |

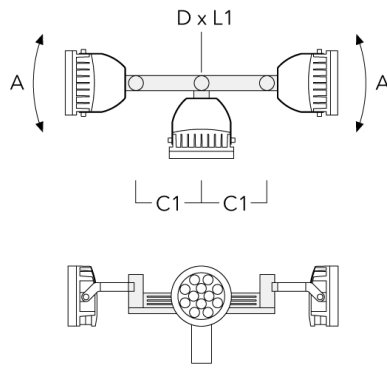

| | | | | | | |
|--|----------|------|-----|-----------|-------|-----------|
| TA4 Mounting bracket, quad (Ø 108 x 200) | 147-0100 | ±90° | 650 | 108 x 200 | 24.20 | 108 x 200 |
|--|----------|------|-----|-----------|-------|-----------|

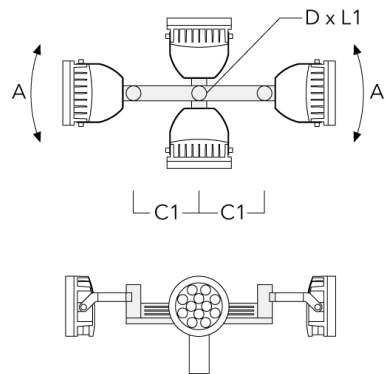

FLC240-CC LED

Pole clamp TS

| Description | Part ID | D1 | Weight (kg) | D |
|--|----------|-------|-------------|-------|
| TS1-2/M12 Pole clamp, single (Ø 76-89) | 147-0543 | 76-89 | 1.40 | 76-89 |

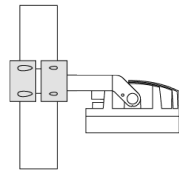
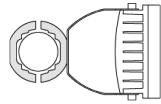

D1

| | | | | |
|--|----------|---------|------|---------|
| TS1-2/M12 Pole clamp, single (Ø 102-114) | 147-0526 | 102-114 | 1.50 | 102-114 |
|--|----------|---------|------|---------|

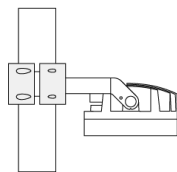
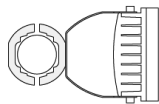

D1

FLC240-CC LED

| Description | Part ID | D1 | Weight (kg) | D |
|--|----------|---------|-------------|---------|
| TS1-2/M12 Pole clamp, single (Ø 114-133) | 147-0544 | 114-133 | 1.70 | 114-133 |

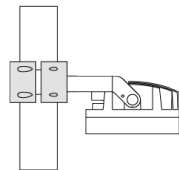
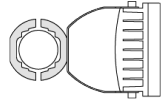

D1

| | | | | |
|--|----------|-------|------|-------|
| TS2-2/M12 Pole clamp, double (Ø 76-89) | 147-0545 | 76-89 | 1.40 | 76-89 |
|--|----------|-------|------|-------|

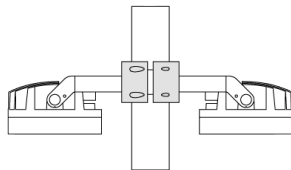
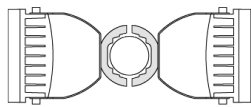

D1

FLC240-CC LED

| Description | Part ID | D1 | Weight (kg) | D |
|--|----------|---------|-------------|---------|
| TS2-2/M12 Pole clamp, double (Ø 102-114) | 147-0527 | 102-114 | 1.50 | 102-114 |

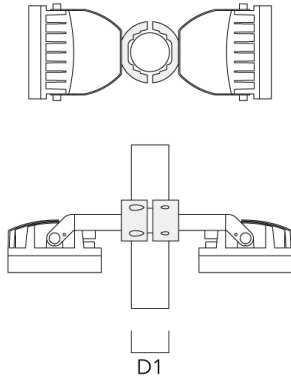

| | | | | |
|--|----------|---------|------|---------|
| TS2-2/M12 Pole clamp, double (Ø 114-133) | 147-0546 | 114-133 | 1.60 | 114-133 |
|--|----------|---------|------|---------|

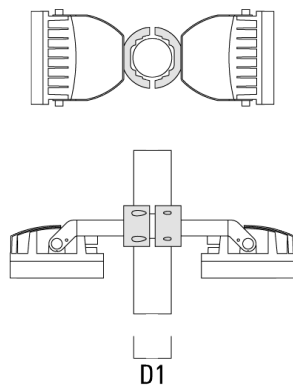

FLC240-CC LED

Pole clamp PC

| Description | Part ID | D1 | Weight (kg) |
|---|----------|-------|-------------|
| PC2 76-89/60 Pole clamp, double (Ø 76-89) | 139-2703 | 76-89 | 1.00 |

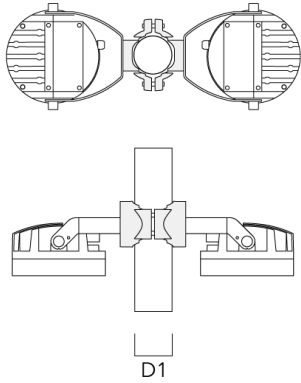

| | | | |
|---|----------|-------|------|
| PC1 76-89/60 Pole clamp, single (Ø 76-89) | 139-2702 | 76-89 | 1.00 |
|---|----------|-------|------|

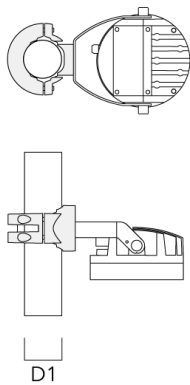

FLC240-CC LED

| Description | Part ID | D1 | Weight (kg) |
|--|----------|---------|-------------|
| PC2 102-114/60 Pole clamp, double (Ø 102-114) | 139-2707 | 102-114 | 1.20 |



| | | | |
|--|----------|---------|------|
| PC1 102-114/60 Pole clamp, single (Ø 102-114) | 139-2706 | 102-114 | 1.20 |
|--|----------|---------|------|



FLC240-CC LED

| Description | Part ID | D1 | Weight (kg) |
|--|----------|---------|-------------|
| PC2 114-133/60 Pole clamp, double (Ø 114-133) | 139-2709 | 114-133 | 1.40 |



| | | | |
|--|----------|---------|------|
| PC1 114-133/60 Pole clamp, single (Ø 114-133) | 139-2708 | 114-133 | 1.40 |
|--|----------|---------|------|



FLC240-CC LED

| Description | Part ID | D1 | Weight (kg) |
|--|----------|--------|-------------|
| PC2 82-109/60 Pole camp, double (Ø 82-109) | 139-2705 | 82-109 | 1.10 |



| | | | |
|--|----------|--------|------|
| PC1 82-109/60 Pole camp, single (Ø 82-109) | 139-2704 | 82-109 | 1.10 |
|--|----------|--------|------|

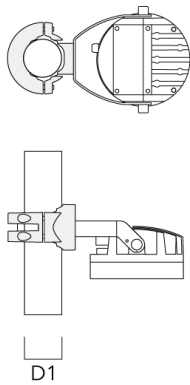

Optical Accessories

Wallwash lens

| Description | Part ID | Additional information | C1 |
|------------------|----------|--|-----|
| IO-20-FLC240-LED | 139-1854 | for symmetric [M] medium beam luminaire only | 289 |

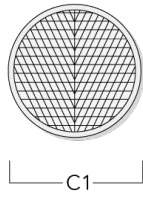

Linear spread lens

| Description | Part ID | C1 |
|---------------------------|----------|-----|
| Linear spread lens IO-180 | 139-1855 | 289 |

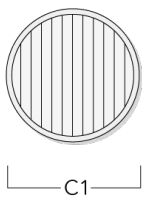

FLC240-CC LED

Snoot

| Description | Part ID | A | C1 |
|---------------|----------|-----|-----|
| ET-FLC240-LED | 139-1859 | 200 | 346 |

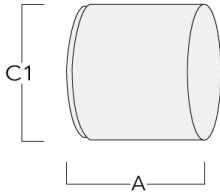

Glare shield

| Description | Part ID | A | C1 |
|---------------|----------|-----|-----|
| ES-FLC240-LED | 139-1858 | 200 | 346 |

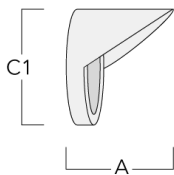

FLC240-CC LED

Flood lens

| Description | Part ID | C1 |
|-------------------|----------|-----|
| IO-360-FLC240-LED | 139-1856 | 289 |

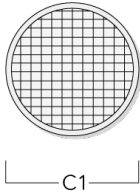

Honeycomb louvre

| Description | Part ID | C1 | H1 |
|---------------------------------|----------|-----|----|
| IW-FLC240-CC LED - [E][EE][EES] | 139-1857 | 279 | |

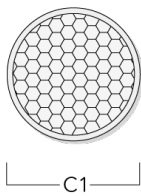

FLC240-CC LED

| Description | Part ID | C1 | H1 |
|---------------------|----------|-----|-----|
| IW-FLC24_EES-CC LED | 139-2433 | 205 | 160 |

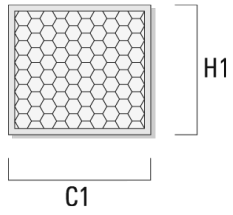

FLC240-CC LED

Control

DMX Controller

| Description | Part ID |
|----------------|----------|
| DMX Controller | 400-0469 |

DMX Controller (smart)

| Description | Part ID | Additional information |
|------------------------|----------|---|
| DMX Controller (smart) | 400-0470 | IP20. The Touch Panel is an intuitive and easy-to-use keypad or one DMX universe. It can store up to 36 scenes; alternatively, via |



FLC240-CC LED

DMX Controller - RDM ready

| Description | Part ID |
|----------------------------|----------|
| DMX Controller - RDM ready | 400-0471 |



DMX Splitter

| Description | Part ID |
|--------------|----------|
| DMX Splitter | 400-0473 |



FLC240-CC LED

DMX Booster Box

| Description | Part ID |
|-----------------|----------|
| DMX Booster Box | 400-0474 |



DMX Motion Sensor

| Description | Part ID |
|-------------------|----------|
| DMX Motion Sensor | 400-0478 |



WE-EF LEUCHTEN GmbH

Töpinger Straße 16, 29646 Bispingen, Germany - Phone: +49 5194 909-0
 info@we-ef.com - <https://we-ef.com>

Subject to technical changes and errors. - Generated on 10/03/2025

FLC240-CC LED

DMX Termination Plug

| Description | Part ID |
|----------------------|----------|
| DMX Termination Plug | 400-0475 |



DMX Plug and Socket

| Description | Part ID |
|---------------------|----------|
| DMX Plug and Socket | 400-0479 |



FLC240-CC LED

DMX Combination Cable

| Description | Part ID |
|-----------------------|----------|
| DMX Combination Cable | 400-0480 |



DMX Wireless Repeater

| Description | Part ID |
|-----------------------|----------|
| DMX Wireless Repeater | 400-0477 |



FLC240-CC LED

DMX Wireless Transceiver

| Description | Part ID |
|--------------------------|----------|
| DMX Wireless Transceiver | 400-0476 |



DMX Controller (smart) - RDM ready

| Description | Part ID |
|------------------------------------|----------|
| DMX Controller (smart) - RDM ready | 400-0472 |



R2C Ready to Connect

| Description | Part ID |
|----------------------------|----------|
| R2C Ready to Connect (top) | 430-0019 |

WE-EF LEUCHTEN GmbH

Töpinger Straße 16, 29646 Bispingen, Germany - Phone: +49 5194 909-0
 info@we-ef.com - <https://we-ef.com>

Subject to technical changes and errors. - Generated on 10/03/2025

139-2142+139-1854

FLC240-CC LED

we-ef

DMX Wireless Antenna

| Description | Part ID |
|-----------------|----------|
| Antenna RF5dB | 430-0036 |
| Antenna RF1.8dB | 430-0018 |

WE-EF LEUCHTEN GmbH

Töpinger Straße 16, 29646 Bispingen, Germany - Phone: +49 5194 909-0
info@we-ef.com - <https://we-ef.com>

Subject to technical changes and errors. - Generated on 10/03/2025