



### Beschreibung

RGBW/RGBA Farbwechsler. IP66, SKI. SKII auf Anfrage. IK07. Korrosionsbeständiger Aluminiumguss. PCS beschichtete Edelstahlschrauben. 5CE Korrosionsschutz. CCG® Controlled Compression Gasket Silikondichtung. Sicherheitsglas. Eine Kabelverschraubung, eine zweite Kabelverschraubung zur Durchverdrahtung auf Anfrage. Eingebaute elektronische Betriebsgeräte, thermisch getrennt. CAD-optimierte OLC® One LED Concept Technik zur Lichtlenkung und Entblendung. Eingebaute LED Platine mit WE-EF Colour Boost Technologie. Die Colour Boost Technologie ermöglicht eine gezielte Erhöhung des Lichtstroms einzelner Kanäle oder Farben über 100% hinaus. Dabei kann der maximale LED-Nennstrom pro Kanal, bei gleichzeitigem Betrieb von nur 3 oder weniger Kanälen bis auf 140% des normalen LED-Nennstroms beim Betrieb von allen 4 Kanälen gleichzeitig, im Rahmen der zur Verfügung stehenden Gesamtleistung des Scheinwerfers, erhöht werden.

DMX Schnittstelle. M20 Kabelverschraubung für Netz- und DMX-Kabel vorgesehen, WE-EF empfiehlt ein Kombikabel für DMX & Power "Power PUR-SR 3x1,5 + DMX".

Gewicht	13.80 kg
Lichtverteilung	wallwash
Lichtquelle	LED-24/96W - RGBA
CRI	20
Netz	EVG
LEDs	24
Bemessungsleistung	100 W

### Nominal Lichtstrom (lm)

LED Lumen	275
Total Lumen	6600
Tj	85

### Bemessungslichtstrom (lm)

LED Lumen	175.2
Total Lumen	4204.4
Ta	25

## FLC240-CC LED

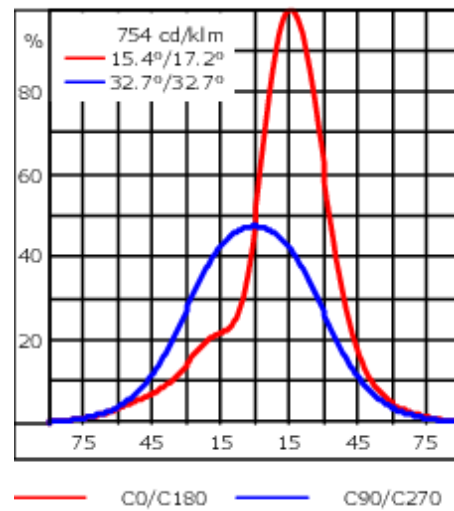
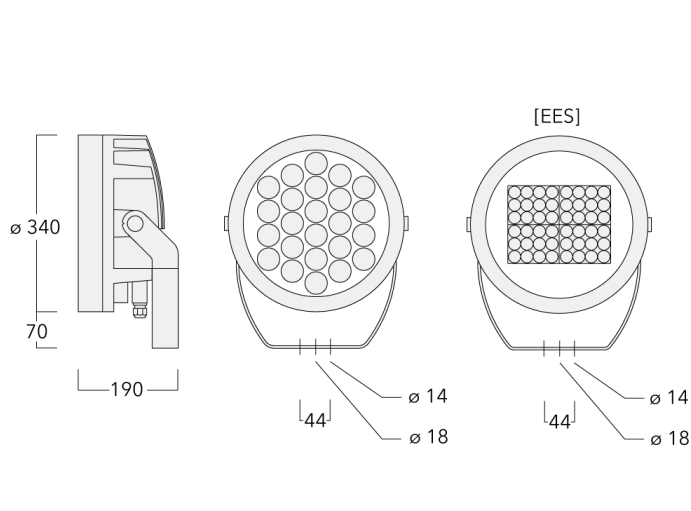

## Spezifikationen

### Materialbeschreibung

Gehäuse	Korrosionsbeständiger Aluminiumguss
Abdeckung	Sicherheitsglasscheibe
Farben	<div style="display: flex; flex-direction: column; gap: 5px;"> <div><span style="display: inline-block; width: 20px; height: 10px; background-color: black; margin-right: 5px;"></span> RAL9004 Signalschwarz</div> <div><span style="display: inline-block; width: 20px; height: 10px; background-color: #cccccc; margin-right: 5px;"></span> RAL9006 Weißaluminium</div> <div><span style="display: inline-block; width: 20px; height: 10px; background-color: #808080; margin-right: 5px;"></span> RAL9007 Graualuminium</div> <div><span style="display: inline-block; width: 20px; height: 10px; background-color: #333333; margin-right: 5px;"></span> RAL7016 Anthrazitgrau</div> <div><span style="display: inline-block; width: 20px; height: 10px; background-color: #e0e0e0; margin-right: 5px;"></span> RAL9016 Verkehrsweiß</div> </div>
Dichtung	CCG® Silikondichtung
Schrauben	PCS beschichtete Edelstahlschrauben
Schutzart	IP66
Schlagfestigkeit	IK07
Korrosionsbeständigkeit	5CE
Windangriffsfläche	0.090 m <sup>2</sup>

### Elektrische Beschreibung

Netz	220-240V / 50-60 Hz
Netzgerät / Vorschaltgerät	DMX
Leistungsfaktor	> 0.9
Überspannungsschutz	1/2 kV (optional SP10)

#### WE-EF LEUCHTEN GmbH

Töpinger Straße 16, 29646 Bispingen, Germany - Tel: +49 5194 909-0

info.germany@we-ef.com - <https://we-ef.com/de>

Technische Änderungen und Irrtümer vorbehalten. - Erstellt am 10.03.2025

**139-2142+139-1854**

**FLC240-CC LED**

**we-ef**

### **Weitere Informationen**

---

Lebensdauer	Ta=25° L90B10 > 90000h
-------------	------------------------

---

**WE-EF LEUCHTEN GmbH**

Töpinger Straße 16, 29646 Bispingen, Germany - Tel: +49 5194 909-0  
info.germany@we-ef.com - <https://we-ef.com/de>

Technische Änderungen und Irrtümer vorbehalten. - Erstellt am 10.03.2025

## Montagezubehör

## Mastaufsatztraverse TA

Beschreibung	Artikelnummer	A	C1	D × L1	Gewicht (kg)	D × S
TA1 Mastaufsatztraverse, einfach* (Ø 76 x 200)	147-0023		130	76 x 200	1.90	76 x 200

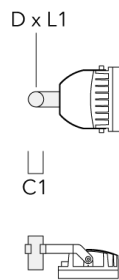

TA2 Mastaufsatztraverse, zweifach (Ø 76 x 200)	147-0024		130	76 x 200	1.90	76 x 200
--	----------	--	-----	----------	------	----------

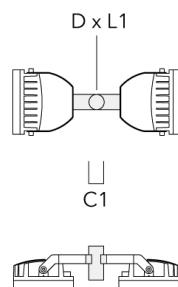

**FLC240-CC LED**

Beschreibung	Artikelnummer	A	C1	D x L1	Gewicht (kg)	D x S
TA2-L Mastaufsatztraverse, zweifach (Ø 76 x 200)	147-0105	±90°	420	76 x 200	16.10	76 x 200

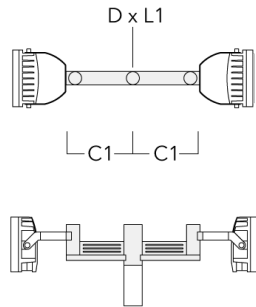

TA3 Mastaufsatztraverse, dreifach (Ø 89 x 200)	147-0025	±90°	650	89 x 200	17.90	89 x 200
--	----------	------	-----	----------	-------	----------



**FLC240-CC LED**

Beschreibung	Artikelnummer	A	C1	D × L1	Gewicht (kg)	D × S
TA4 Mastaufsatztraverse, vierfach (Ø 89 x 200)	147-0099	±90°	650	89 x 200	20.80	89 x 200



TA1 Mastaufsatztraverse, einfach (Ø 108 x 200)	147-0096		130	108 x 200	7.50	108 x 200
--	----------	--	-----	-----------	------	-----------

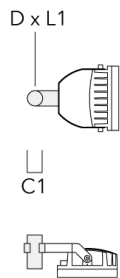

**FLC240-CC LED**

Beschreibung	Artikelnummer	A	C1	D x L1	Gewicht (kg)	D x S
TA2 Mastaufsatztraverse, zweifach (Ø 108 x 200)	147-0097		130	108 x 200	7.50	108 x 200

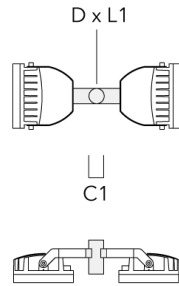

TA2-L Mastaufsatztraverse, zweifach (Ø 108 x 200)	147-0148	±90°	420	108 x 200	20.20	108 x 200
---	----------	------	-----	-----------	-------	-----------

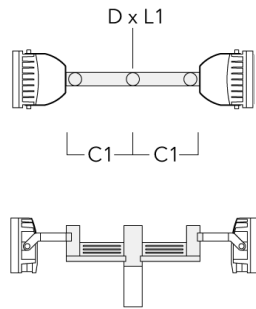

**FLC240-CC LED**

Beschreibung	Artikelnummer	A	C1	D x L1	Gewicht (kg)	D x S
TA3 Mastaufsatztraverse, dreifach (Ø 108 x 200)	147-0098	±90°	650	108 x 200	24.20	108 x 200

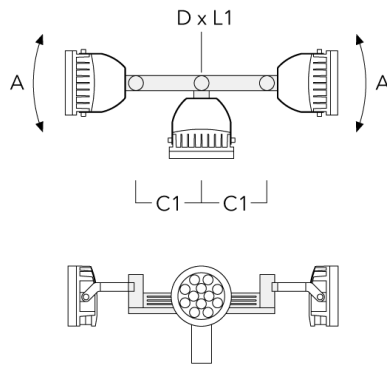

TA4 Mastaufsatztraverse, vierfach (Ø 108 x 200)	147-0100	±90°	650	108 x 200	24.20	108 x 200
---	----------	------	-----	-----------	-------	-----------

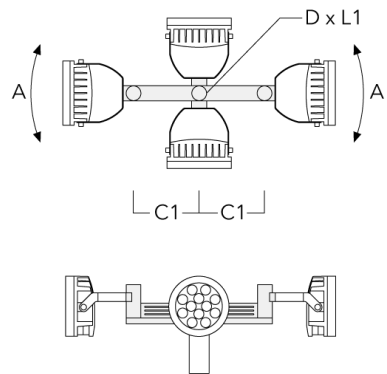



## FLC240-CC LED

## Mastschelle TS

Beschreibung	Artikelnummer	D1	Gewicht (kg)	D
TS1-2/M12 Mastschelle, einfach (Ø 76-89)	147-0543	76-89	1.40	76-89

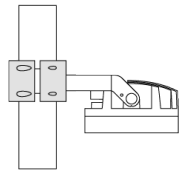
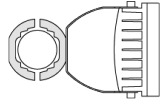

D1

TS1-2/M12 Mastschelle, einfach (Ø 102-114)	147-0526	102-114	1.50	102-114
--	----------	---------	------	---------

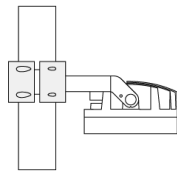
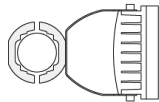

D1

**FLC240-CC LED**

Beschreibung	Artikelnummer	D1	Gewicht (kg)	D
TS1-2/M12 Mastschelle, einfach (Ø 114-133)	147-0544	114-133	1.70	114-133

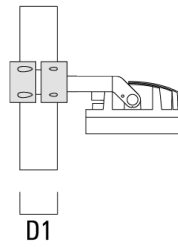
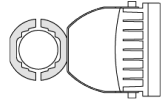

TS2-2/M12 Mastschelle, zweifach (Ø 76-89)	147-0545	76-89	1.40	76-89
---	----------	-------	------	-------

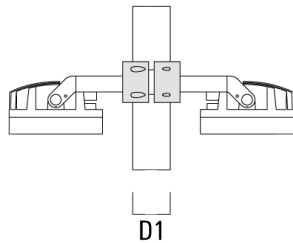
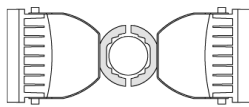

**FLC240-CC LED**

Beschreibung	Artikelnummer	D1	Gewicht (kg)	D
TS2-2/M12 Mastschelle, zweifach (Ø 102-114)	147-0527	102-114	1.50	102-114

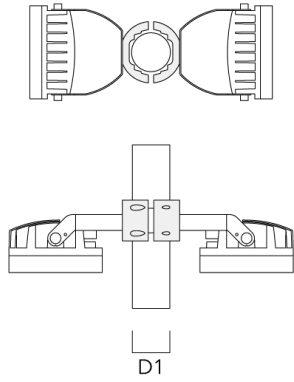

TS2-2/M12 Mastschelle, zweifach (Ø 114-133)	147-0546	114-133	1.60	114-133
---	----------	---------	------	---------

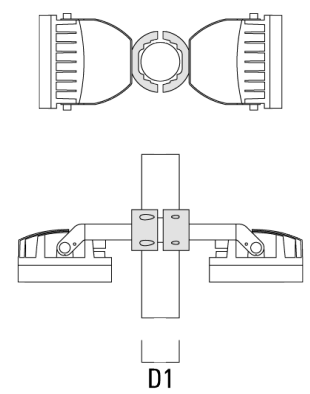

## FLC240-CC LED

## Mastschelle PC

Beschreibung	Artikelnummer	D1	Gewicht (kg)
PC2 76-89/60 Mastschelle, zweifach (Ø 76-89)	139-2703	76-89	1.00

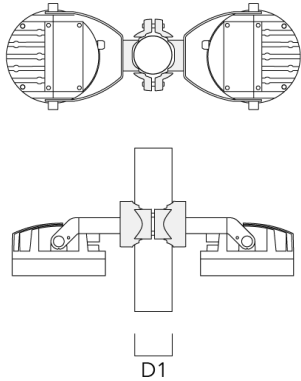

PC1 76-89/60 Mastschelle, einfach (Ø 76-89)	139-2702	76-89	1.00
---	----------	-------	------

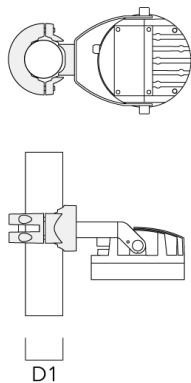

## FLC240-CC LED

Beschreibung	Artikelnummer	D1	Gewicht (kg)
PC2 102-114/60 Mastschelle, zweifach (Ø 102-114)	139-2707	102-114	1.20



PC1 102-114/60 Mastschelle, einfach (Ø 102-114)	139-2706	102-114	1.20
--	----------	---------	------



**FLC240-CC LED**

Beschreibung	Artikelnummer	D1	Gewicht (kg)
PC2 114-133/60 Mastschelle, zweifach (Ø 114-133)	139-2709	114-133	1.40



PC1 114-133/60 Mastschelle, einfach (Ø 114-133)	139-2708	114-133	1.40
---	----------	---------	------



## FLC240-CC LED

Beschreibung	Artikelnummer	D1	Gewicht (kg)
PC2 82-109/60 Mastschelle, zweifach (Ø 82-109)	139-2705	82-109	1.10



PC1 82-109/60 Mastschelle, einfach (Ø 82-109)	139-2704	82-109	1.10
--	----------	--------	------



**Optisches Zubehör****Wallwash Linse**

Beschreibung	Artikelnummer	Weitere Informationen	C1
IO-20-FLC240-LED	139-1854	for symmetric [M] medium beam luminaire only	289

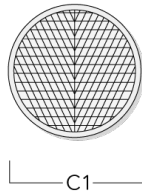
**Streulinse bandförmig**

Beschreibung	Artikelnummer	C1
Streulinse IO-180 bandförmig	139-1855	289

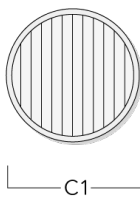



## FLC240-CC LED

## Abblendtubus

Beschreibung	Artikelnummer	A	C1
ET-FLC240-LED	139-1859	200	346

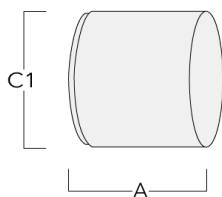

## Seitenblende

Beschreibung	Artikelnummer	A	C1
ES-FLC240-LED	139-1858	200	346

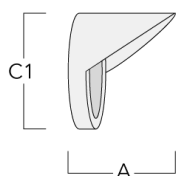

## FLC240-CC LED

## Streulinse allseitig

Beschreibung	Artikelnummer	C1
IO-360-FLC240-LED	139-1856	289

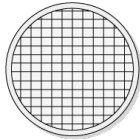

## Wabenblende

Beschreibung	Artikelnummer	C1	H1
IW-FLC240-CC LED - [E][EE][EES]	139-1857	279	

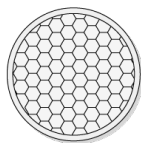

**FLC240-CC LED**

---

Beschreibung	Artikelnummer	C1	H1
IW-FLC24_EES-CC LED	139-2433	205	160

---

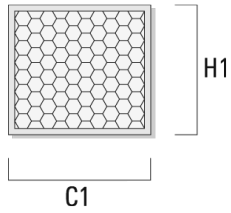

**FLC240-CC LED**

**Steuerung**

**DMX Controller**

Beschreibung	Artikelnummer
DMX Controller	400-0469

**DMX Controller (smart)**

Beschreibung	Artikelnummer	Weitere Informationen
DMX Controller (smart)	400-0470	IP20. The Touch Panel is an intuitive and easy-to-use keypad or one DMX universe. It can store up to 36 scenes; alternatively, via ....



**FLC240-CC LED**

**DMX Controller - RDM ready**

Beschreibung	Artikelnummer
DMX Controller - RDM ready	400-0471



**DMX Splitter**

Beschreibung	Artikelnummer
DMX Splitter	400-0473



## FLC240-CC LED

## DMX Booster Box

Beschreibung	Artikelnummer
DMX Booster Box	400-0474



## DMX Motion Sensor

Beschreibung	Artikelnummer
DMX Motion Sensor	400-0478



**FLC240-CC LED**

**DMX Termination Plug**

---

Beschreibung	Artikelnummer
DMX Termination Plug	400-0475

---



---

**DMX Plug and Socket**

---

Beschreibung	Artikelnummer
DMX Plug and Socket	400-0479

---



**FLC240-CC LED**

**DMX Combination Cable**

---

Beschreibung	Artikelnummer
DMX Combination Cable	400-0480

---



---

**DMX Wireless Repeater**

---

Beschreibung	Artikelnummer
DMX Wireless Repeater	400-0477

---





**FLC240-CC LED****DMX Wireless Transceiver**

Beschreibung	Artikelnummer
DMX Wireless Transceiver	400-0476

**DMX Controller (smart) - RDM ready**

Beschreibung	Artikelnummer
DMX Controller (smart) - RDM ready	400-0472

**R2C Ready to Connect**

Beschreibung	Artikelnummer
R2C Ready to Connect (oben)	430-0019

**WE-EF LEUCHTEN GmbH**

Töpinger Straße 16, 29646 Bispingen, Germany - Tel: +49 5194 909-0

info.germany@we-ef.com - <https://we-ef.com/de>

Technische Änderungen und Irrtümer vorbehalten. - Erstellt am 10.03.2025

**139-2142+139-1854**

**FLC240-CC LED**

**we-ef**

**DMX Wireless Antenna**

Beschreibung	Artikelnummer
Antenne RF 5dB	430-0036
Antenne RF1.8 dB	430-0018

**WE-EF LEUCHTEN GmbH**

Töpinger Straße 16, 29646 Bispingen, Germany - Tel: +49 5194 909-0

info.germany@we-ef.com - <https://we-ef.com/de>

Technische Änderungen und Irrtümer vorbehalten. - Erstellt am 10.03.2025