



Description

Changement de couleurs RGBW/RGBA. IP66. Classe I. Classe II sur demande. IK07. Corps en fonte d'aluminium. Visserie inox avec traitement PCS. Protection contre la corrosion 5CE. Joint silicone. Verre de sécurité. LED contrôlables par système DMX. Technologie sans fil DMX Wireless disponible.

Poids	13.80 kg
Distribution de la lumière	wallwash
Source lumineuse	LED-24/96W - RGBA
IRC	20
Alimentation électrique	ballast électronique
LEDs	24
Rated input power	100 W

Flux lumineux nominal (lm)

LED Lumen	275
Total Lumen	6600
Tj	85

Rated lumens (lm)

LED Lumen	175.2
Total Lumen	4204.4
Ta	25

WE-EF Switzerland AG

Himmelrichstrasse 6, 6003 Luzern - Téléphone: +41 22 752 49 94
 info.switzerland@we-ef.com - https://we-ef.com/ch_fr

Sous réserve de modifications techniques et d'erreurs. - Généré le 10/03/2025

FLC240-CC LED

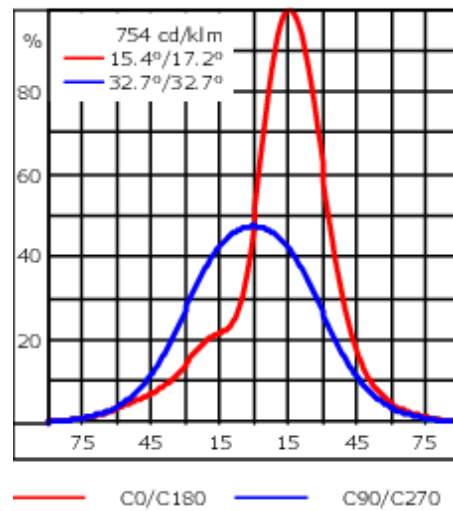
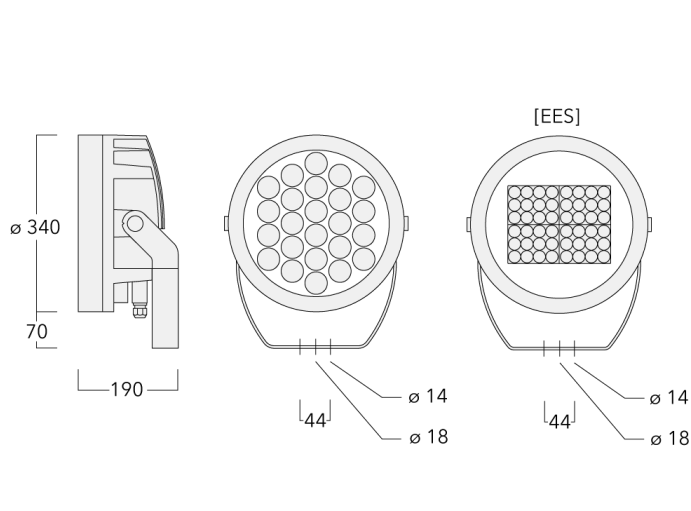

Spécifications

Description du matériel

Corps	Corps en fonte d'aluminium
Lentille	Verre de sécurité
Couleurs	<div style="display: flex; align-items: center;"> <div style="width: 20px; height: 15px; background-color: black; margin-right: 5px;"></div> RAL9004 Noir de sécurité </div> <div style="display: flex; align-items: center; margin-top: 5px;"> <div style="width: 20px; height: 15px; background-color: gray; margin-right: 5px;"></div> RAL9007 Aluminium gris </div> <div style="display: flex; align-items: center; margin-top: 5px;"> <div style="width: 20px; height: 15px; background-color: #333; margin-right: 5px;"></div> RAL7016 Gris anthracite </div> <div style="display: flex; align-items: center; margin-top: 5px;"> <div style="width: 20px; height: 15px; background-color: #eee; margin-right: 5px;"></div> RAL9016 Blanc signalisation </div>
Joint	Joint silicone CCG®
Visserie	Visserie inox avec traitement PCS
IP	IP66
IK	IK07
Protection contre la corrosion	5CE
Surface exposée au vent	0.090 m ²

Description électrique

Driver	DMX
Power factor	> 0.9

Informations complémentaires

Durée de vie	Ta=25° L90B10 > 90000h
--------------	------------------------

WE-EF Switzerland AG

Himmelrichstrasse 6, 6003 Luzern - Téléphone: +41 22 752 49 94

info.switzerland@we-ef.com - https://we-ef.com/ch_fr

Sous réserve de modifications techniques et d'erreurs. - Généré le 10/03/2025

Accessoires d'installation

Traverse pour mâts

Description	Référence	A	C1	D x L1	Poids (kg)	D x S
TA1 traverse simple (Ø 76 x 200)	147-0023		130	76 x 200	1.90	76 x 200

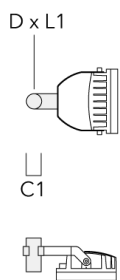

TA2 traverse double (Ø 76 x 200)	147-0024		130	76 x 200	1.90	76 x 200
----------------------------------	----------	--	-----	----------	------	----------

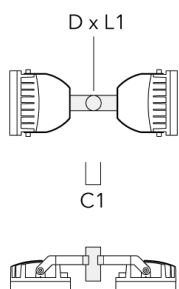

FLC240-CC LED

Description	Référence	A	C1	D x L1	Poids (kg)	D x S
TA2-L traverse longue orientable (Ø 76 x 200)	147-0105	±90°	420	76 x 200	16.10	76 x 200

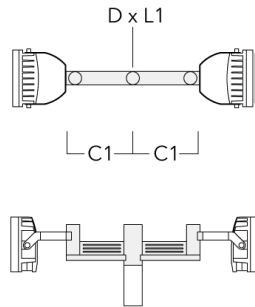

TA3 traverse triple orientable (Ø 89 x 200)	147-0025	±90°	650	89 x 200	17.90	89 x 200
---	----------	------	-----	----------	-------	----------

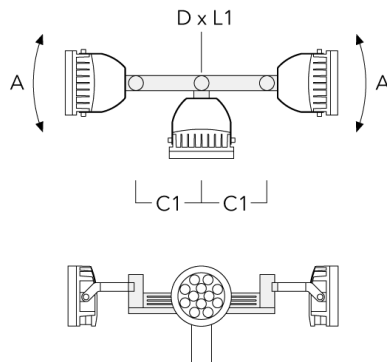

FLC240-CC LED

Description	Référence	A	C1	D x L1	Poids (kg)	D x S
TA4 Traverse pour 4 projecteurs (Ø 89 x 200)	147-0099	±90°	650	89 x 200	20.80	89 x 200



TA1 traverse simple (Ø 108 x 200)	147-0096		130	108 x 200	7.50	108 x 200
-----------------------------------	----------	--	-----	-----------	------	-----------

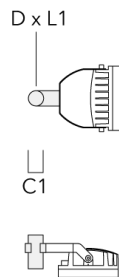

FLC240-CC LED

Description	Référence	A	C1	D × L1	Poids (kg)	D × S
TA2 traverse double (Ø 108 x 200)	147-0097		130	108 x 200	7.50	108 x 200

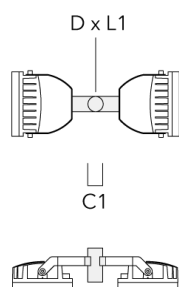

TA2-L traverse longue orientable (Ø 108 x 200)	147-0148	±90°	420	108 x 200	20.20	108 x 200
--	----------	------	-----	-----------	-------	-----------

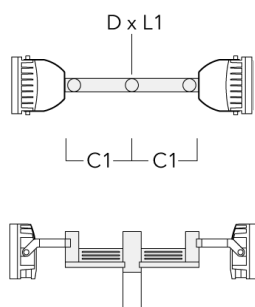

FLC240-CC LED

Description	Référence	A	C1	D x L1	Poids (kg)	D x S
TA3 traverse triple orientable (Ø 108 x 200)	147-0098	±90°	650	108 x 200	24.20	108 x 200



TA4 Traverse pour 4 projecteurs (Ø 108 x 200)	147-0100	±90°	650	108 x 200	24.20	108 x 200
---	----------	------	-----	-----------	-------	-----------

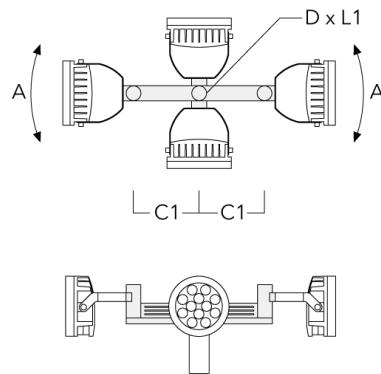

FLC240-CC LED

Collier pour mâts TS

Description	Référence	D1	Poids (kg)	D
TS1-2/M12 collier simple pour tube (Ø 76-89)	147-0543	76-89	1.40	76-89

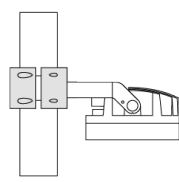
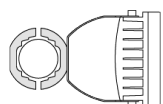

D1

TS1-2/M12 collier simple pour tube (Ø 102-114)	147-0526	102-114	1.50	102-114
--	----------	---------	------	---------

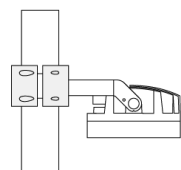
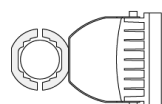

D1

FLC240-CC LED

Description	Référence	D1	Poids (kg)	D
TS1-2/M12 collier simple pour tube (Ø 114-133)	147-0544	114-133	1.70	114-133

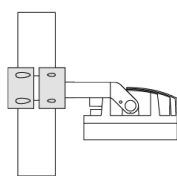

D1

TS2-2/M12 collier double pour tube (Ø 76-89)	147-0545	76-89	1.40	76-89
---	----------	-------	------	-------

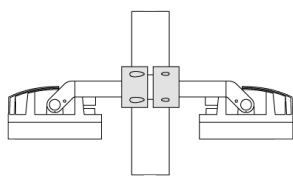
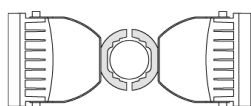

D1

FLC240-CC LED

Description	Référence	D1	Poids (kg)	D
TS2-2/M12 collier double pour tube (Ø 102-114)	147-0527	102-114	1.50	102-114

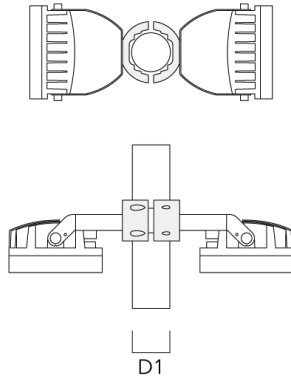

TS2-2/M12 collier double pour tube (Ø 114-133)	147-0546	114-133	1.60	114-133
---	----------	---------	------	---------

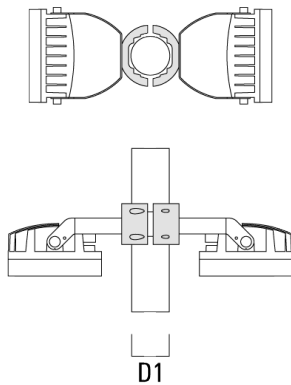

FLC240-CC LED

Collier pour mâts PC

Description	Référence	D1	Poids (kg)
PC2 76-89/60 collier double pour tube (Ø 76-89)	139-2703	76-89	1.00

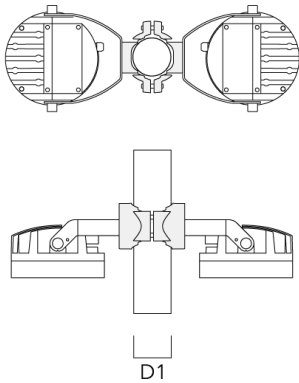

PC1 76-89/60 collier simple (Ø 76-89)	139-2702	76-89	1.00
---------------------------------------	----------	-------	------

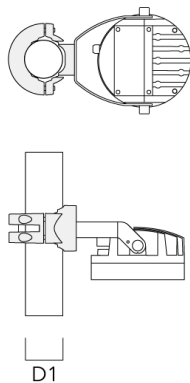

FLC240-CC LED

Description	Référence	D1	Poids (kg)
PC2 102-114/60 collier double pour tube (Ø 102-114)	139-2707	102-114	1.20

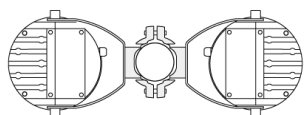

PC1 102-114/60 collier simple (Ø 102-114)	139-2706	102-114	1.20
---	----------	---------	------



FLC240-CC LED

Description	Référence	D1	Poids (kg)
PC2 114-133/60 collier double pour tube (Ø 114-133)	139-2709	114-133	1.40

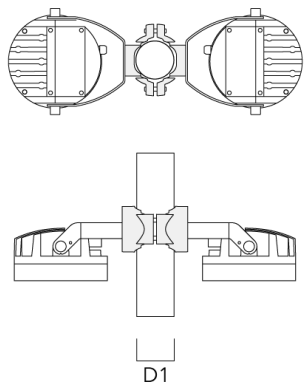

PC1 114-133/60 collier simple (Ø 114-133)	139-2708	114-133	1.40
---	----------	---------	------

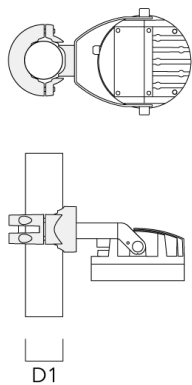

FLC240-CC LED

Description	Référence	D1	Poids (kg)
PC2 82-109/60 collier double pour tube (Ø 82-109)	139-2705	82-109	1.10



PC1 82-109/60 collier simple (Ø 82-109)	139-2704	82-109	1.10
---	----------	--------	------

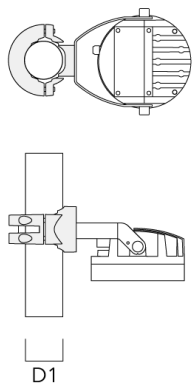

Accessoires Optiques**Lentille ovalisante**

Description	Référence	C1
Linear spread lens IO-180	139-1855	289

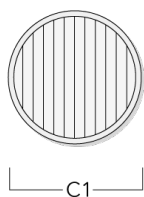
**Canon anti-éblouissement**

Description	Référence	A	C1
ET-FLC240-LED	139-1859	200	346

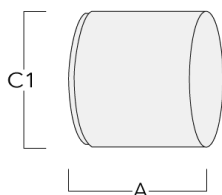

FLC240-CC LED

Visière

Description	Référence	A	C1
ES-FLC240-LED	139-1858	200	346

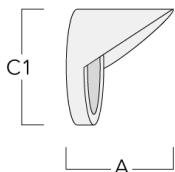

Lentille e'largissante

Description	Référence	C1
IO-360-FLC240-LED	139-1856	289

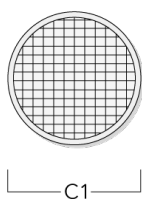

FLC240-CC LED

Grille nid d'abeille

Description	Référence	C1
IW-FLC240-CC LED - [E][EE][EES]	139-1857	279

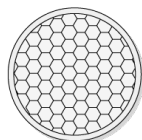

FLC240-CC LED

Control

DMX Controller

Description	Référence
DMX Controller	400-0469

DMX Controller (smart)

Description	Référence	Informations complémentaires
DMX Controller (smart)	400-0470	IP20. The Touch Panel is an intuitive and easy-to-use keypad or one DMX universe. It can store up to 36 scenes; alternatively, via



FLC240-CC LED

DMX Controller - RDM ready

Description	Référence
DMX Controller - RDM ready	400-0471



DMX Splitter

Description	Référence
DMX Splitter	400-0473



WE-EF Switzerland AG

Himmelrichstrasse 6, 6003 Luzern - Téléphone: +41 22 752 49 94

info.switzerland@we-ef.com - https://we-ef.com/ch_fr

Sous réserve de modifications techniques et d'erreurs. - Généré le 10/03/2025

FLC240-CC LED

DMX Booster Box

Description	Référence
DMX Booster Box	400-0474



DMX Motion Sensor

Description	Référence
DMX Motion Sensor	400-0478



WE-EF Switzerland AG

Himmelrichstrasse 6, 6003 Luzern - Téléphone: +41 22 752 49 94

info.switzerland@we-ef.com - https://we-ef.com/ch_fr

Sous réserve de modifications techniques et d'erreurs. - Généré le 10/03/2025

FLC240-CC LED

DMX Termination Plug

Description	Référence
DMX Termination Plug	400-0475



DMX Plug and Socket

Description	Référence
DMX Plug and Socket	400-0479



FLC240-CC LED

DMX Combination Cable

Description	Référence
DMX Combination Cable	400-0480



DMX Wireless Repeater

Description	Référence
DMX Wireless Repeater	400-0477



FLC240-CC LED

DMX Wireless Transceiver

Description	Référence
DMX Wireless Transceiver	400-0476



DMX Controller (smart) - RDM ready

Description	Référence
DMX Controller (smart) - RDM ready	400-0472



R2C Ready to Connect

Description	Référence
R2C Ready to Connect (top)	430-0019

WE-EF Switzerland AG

Himmelrichstrasse 6, 6003 Luzern - Téléphone: +41 22 752 49 94

info.switzerland@we-ef.com - https://we-ef.com/ch_fr

Sous réserve de modifications techniques et d'erreurs. - Généré le 10/03/2025

DMX Wireless Antenna

Description	Référence
Antenne RF 5dB	430-0036
Antenne RF1.8 dB	430-0018