

FLC240-CC LED

**Description**

RGBW/RGBA Colour Changer. RGBW (white in 4000 K, 3000 K available on request) and RGBA. IP66. Class I. IK07. Marine-grade, die-cast aluminium alloy. 5CE superior corrosion protection including PCS hardware. Safety glass lens. Silicone CCG® Controlled Compression Gasket. Two cable glands.

Integral EC electronic converter in thermally separated compartment. Advanced thermal management protects LEDs while optimising lumens output. CAD-optimised optics for superior illumination and glare control. OLC® One LED Concept. LED circuit board with WE-EF Colour Boost Technology.

DMX Interface. For other control interface options to suit specific project requirements, contact WE-EF.

| | |
|--------------------|-------------------|
| Weight | 13.80 kg |
| Light distribution | wallwash |
| Light source | LED-24/96W - RGBA |
| CRI | 20 |
| Power supply | EC |
| LEDs | 24 |
| Rated input power | 100 W |

Nominal Lumen (lm)

| | |
|-------------|------|
| LED Lumen | 275 |
| Total Lumen | 6600 |
| Tj | 85 |

Rated lumens (lm)

| | |
|-------------|--------|
| LED Lumen | 175.2 |
| Total Lumen | 4204.4 |
| Ta | 25 |

FLC240-CC LED

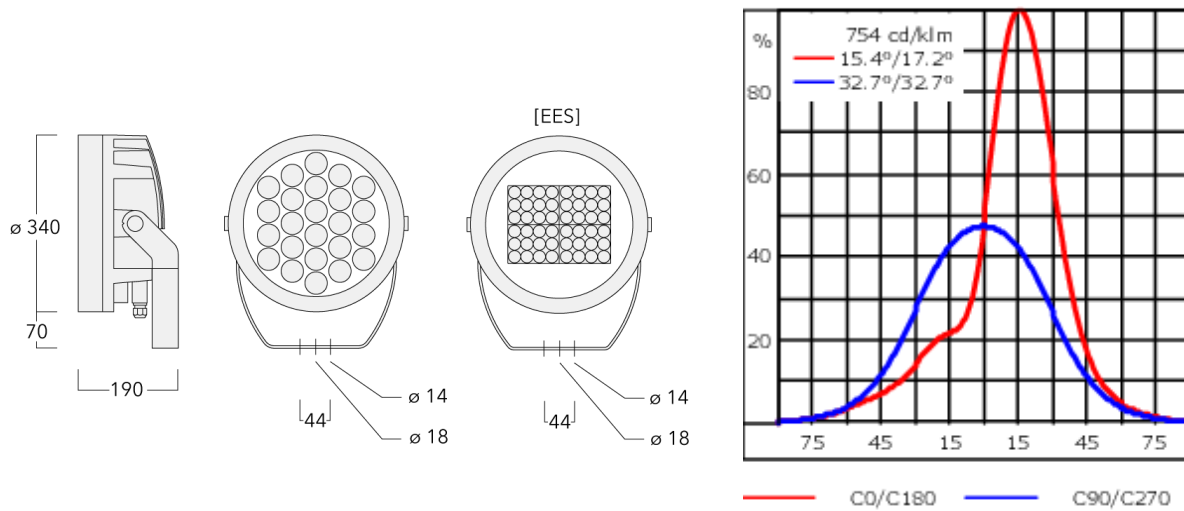

Specifications

Material description

| | |
|----------------------|---------------------------------------------------------------------------------------------------------------------------------------------------------------------------------------------------------------------------------------------------------------------------------------------------------------------------------------------------------------------------------------------------------------------------------------------------------------------------------------------------------------------------------------------------------------------------------------------------------------------------------------------------------------------------------------------------------------------------------------------------------------------------------------------------------------------------------------------|
| Body | Marine-grade, die-cast aluminium alloy |
| Lens | Safety glass lens |
| Colours | <div style="display: flex; align-items: center;"> <div style="width: 20px; height: 15px; background-color: black; margin-right: 5px;"></div> RAL9004 Signal black </div> <div style="display: flex; align-items: center; margin-top: 5px;"> <div style="width: 20px; height: 15px; background-color: grey; margin-right: 5px;"></div> RAL9007 Grey aluminium </div> <div style="display: flex; align-items: center; margin-top: 5px;"> <div style="width: 20px; height: 15px; background-color: darkgrey; margin-right: 5px;"></div> RAL7016 Anthracite grey </div> <div style="display: flex; align-items: center; margin-top: 5px;"> <div style="width: 20px; height: 15px; background-color: white; border: 1px solid black; margin-right: 5px;"></div> RAL9016 Traffic white </div> |
| Gasket | Silicone CCG® Controlled Compression Gasket |
| Fasteners | PCS Polymer Coated Stainless Steel Hardware |
| Ingress protection | IP66 |
| Impact resistance | IK07 |
| Corrosion resistance | 5CE |
| Windage | 0.090 m ² |

Electrical description

| | |
|------------------|---------------------------------------------------------------------|
| Driver / Ballast | Integral EC electronic converter in thermally-separated compartment |
| Power factor | > 0.9 |

Additional information

| | |
|----------|------------------------|
| Lifetime | Ta=25° L90B10 > 90000h |
|----------|------------------------|

Optical Accessories

Wallwash lens

| Description | Part ID | Additional information | C1 |
|---------------------|-------------|----------------------------------------------|-----|
| Wallwash lens IO-20 | 139-1854-AP | for symmetric [M] medium beam luminaire only | 289 |

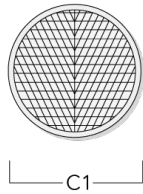

Linear spread lens

| Description | Part ID | C1 |
|---------------------------|----------|-----|
| Linear spread lens IO-180 | 139-1855 | 289 |



FLC240-CC LED

Snoot

| Description | Part ID | A | C1 |
|-------------|----------|-----|-----|
| Snoot ET | 139-1859 | 200 | 346 |

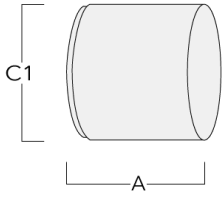

Glare shield

| Description | Part ID | A | C1 |
|-----------------|----------|-----|-----|
| Glare shield ES | 139-1858 | 200 | 346 |

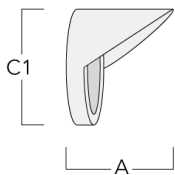

FLC240-CC LED

Flood lens

| Description | Part ID | C1 |
|-------------------|----------|-----|
| Flood lens IO-360 | 139-1856 | 289 |



Honeycomb louvre

| Description | Part ID | C1 | H1 |
|---------------------|----------|-----|----|
| Honeycomb Louvre IW | 139-1857 | 279 | |



FLC240-CC LED

| Description | Part ID | C1 | H1 |
|-----------------------------|----------|-----|-----|
| Honeycomb louvre IW for EES | 139-2433 | 205 | 160 |

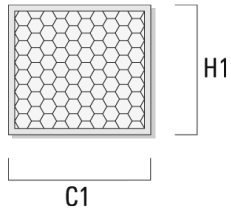

Mounting Accessories

Planted root

| Description | Part ID | D1 | D2 | D3 | D4 | H1 | H2 | M1 | T1 | T2 | Weight (kg) |
|-------------------|-------------|-----|-----|----|----|-----|-----|----|-----|----------|-------------|
| Planted root ESV4 | 300-0461-AP | 150 | 130 | 60 | 89 | 400 | 350 | 8 | 200 | 50 x 100 | 3.85 |

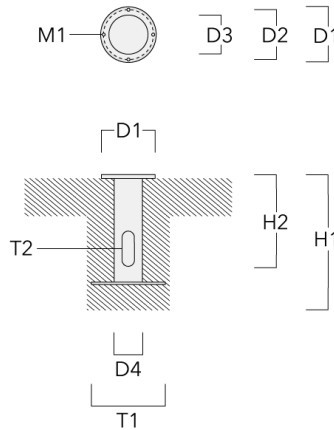

Floodlight mounting bracket TA

| Description | Part ID | A | C1 | D x L1 | Weight (kg) | D x S |
|---------------------------------------------|----------|------|-----|----------|-------------|----------|
| TA2-L Mounting bracket, double (Ø 76 x 200) | 147-0105 | ±90° | 420 | 76 x 200 | 16.10 | 76 x 200 |

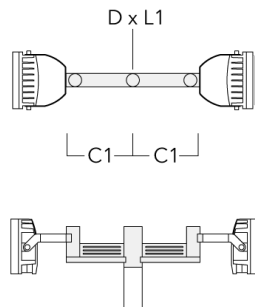

FLC240-CC LED

| Description | Part ID | A | C1 | D x L1 | Weight (kg) | D x S |
|-------------------------------------------|----------|------|-----|----------|-------------|----------|
| TA3 Mounting bracket, triple (Ø 89 x 200) | 147-0025 | ±90° | 650 | 89 x 200 | 17.90 | 89 x 200 |

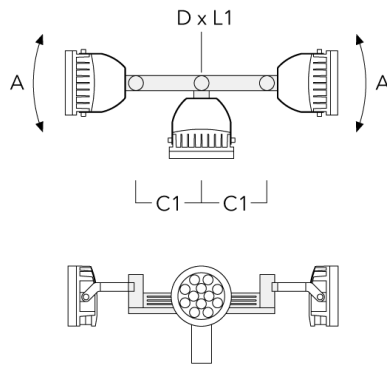

| | | | | | | |
|-----------------------------------------|----------|------|-----|----------|-------|----------|
| TA4 Mounting bracket, quad (Ø 89 x 200) | 147-0099 | ±90° | 650 | 89 x 200 | 20.80 | 89 x 200 |
|-----------------------------------------|----------|------|-----|----------|-------|----------|

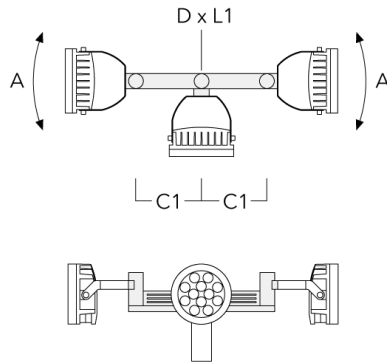

FLC240-CC LED

| Description | Part ID | A | C1 | D × L1 | Weight (kg) | D × S |
|--------------------------------------------|----------|---|-----|-----------|-------------|-----------|
| TA1 Mounting bracket, single (Ø 108 x 200) | 147-0096 | | 130 | 108 x 200 | 7.50 | 108 x 200 |



| | | | | | | |
|--------------------------------------------|----------|--|-----|-----------|------|-----------|
| TA2 Mounting bracket, double (Ø 108 x 200) | 147-0097 | | 130 | 108 x 200 | 7.50 | 108 x 200 |
|--------------------------------------------|----------|--|-----|-----------|------|-----------|

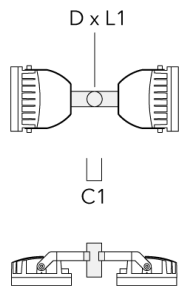

FLC240-CC LED

| Description | Part ID | A | C1 | D x L1 | Weight (kg) | D x S |
|----------------------------------------------|----------|------|-----|-----------|-------------|-----------|
| TA2-L Mounting bracket, double (Ø 108 x 200) | 147-0148 | ±90° | 420 | 108 x 200 | 20.20 | 108 x 200 |

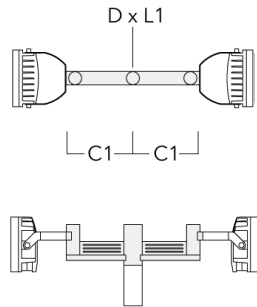

| | | | | | | |
|--------------------------------------------|----------|------|-----|-----------|-------|-----------|
| TA3 Mounting bracket, triple (Ø 108 x 200) | 147-0098 | ±90° | 650 | 108 x 200 | 24.20 | 108 x 200 |
|--------------------------------------------|----------|------|-----|-----------|-------|-----------|

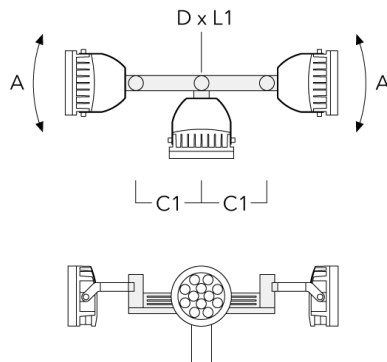

FLC240-CC LED

| Description | Part ID | A | C1 | D × L1 | Weight (kg) | D × S |
|------------------------------------------|----------|------|-----|-----------|-------------|-----------|
| TA4 Mounting bracket, quad (Ø 108 x 200) | 147-0100 | ±90° | 650 | 108 x 200 | 24.20 | 108 x 200 |

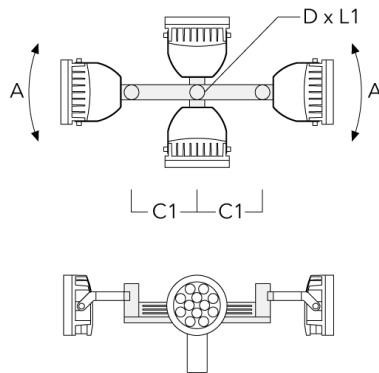

Spigot cap

| Description | Part ID | D1 | Weight (kg) |
|---------------------------------|----------|----------|-------------|
| Spigot Cap KF1-M16 (ø 60 x 100) | 310-9120 | 60 x 100 | 1.40 |

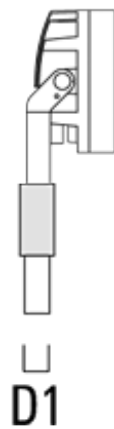

FLC240-CC LED

| Description | Part ID | D1 | Weight (kg) |
|---------------------------------|----------|----------|-------------|
| Spigot Cap KF1-M16 (ø 76 x 100) | 310-9121 | 76 x 100 | 2.2 |

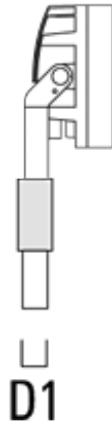

Pole clamp SP - Tilttable

| Description | Part ID | D1 | Weight (kg) | D |
|--------------------------------------|----------|-------|-------------|-------|
| Pole clamp SP1-M16, single (Ø 76-89) | 146-0242 | 76-89 | 1.30 | 76-89 |

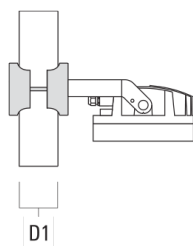

FLC240-CC LED

| Description | Part ID | D1 | Weight (kg) | D |
|--------------------------------------|----------|-------|-------------|---|
| Pole clamp SP2-M16, double (Ø 76-89) | 146-0244 | 76-89 | 1.50 | |

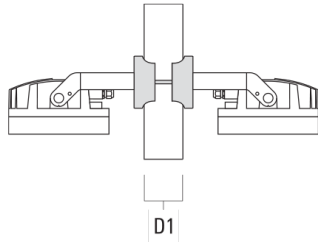

| | | | | |
|--------------------------------------|----------|-------|------|--|
| Pole clamp SP1-M16, single (Ø 38-60) | 146-0241 | 38-60 | 1.30 | |
|--------------------------------------|----------|-------|------|--|

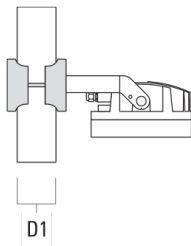

| | | | | |
|--------------------------------------|----------|-------|------|--|
| Pole clamp SP2-M16, double (Ø 38-60) | 146-0243 | 38-60 | 1.50 | |
|--------------------------------------|----------|-------|------|--|

FLC240-CC LED

Junction box

| Description | Part ID | Additional information | A | B | C1 | Weight (kg) |
|----------------------------------------|----------|----------------------------------------------------------------------------------------------------------------------------------------------|-----|-----|----|-------------|
| Junction box JB20 - Cable side entries | 310-9017 | Junction boxes are made from marine-grade, die-cast aluminium alloy. IK10. IP66. For side entries and suitable to be used with cable glands. | 180 | 143 | 51 | 1.02 |

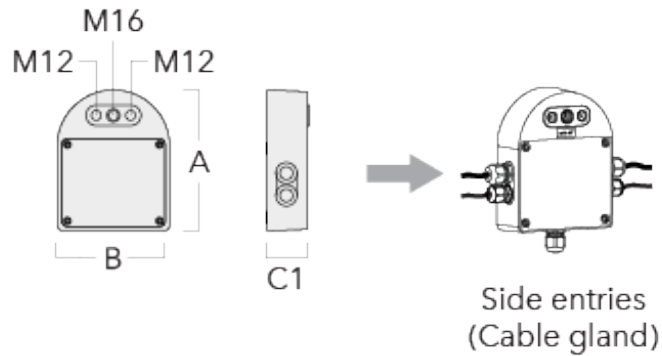

| | | | | | | |
|------------------------------------------|----------|------------------------------------------------------------------------------------------------------------------------------------------|-----|-----|----|------|
| Junction box JB20 - Conduit side entries | 310-9015 | Junction boxes are made from marine-grade, die-cast aluminium alloy. IK10. IP66. For side entries and suitable to be used with conduits. | 180 | 143 | 51 | 1.02 |
|------------------------------------------|----------|------------------------------------------------------------------------------------------------------------------------------------------|-----|-----|----|------|

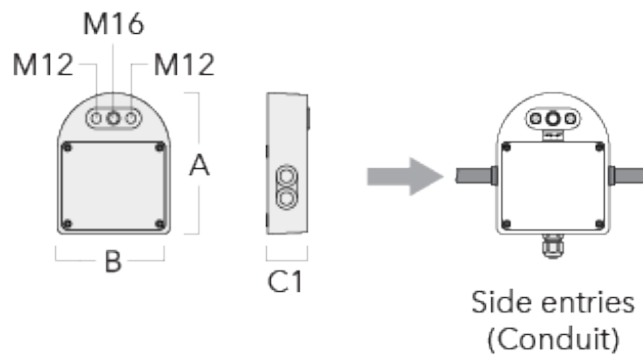

FLC240-CC LED

| Description | Part ID | Additional information | A | B | C1 | Weight (kg) |
|----------------------------------|----------|----------------------------------------------------------------------------------------------------|-----|-----|----|-------------|
| Junction box JB20 - Wall entries | 310-9019 | Junction boxes are made from marine-grade, die-cast aluminium alloy. IK10. IP66. For wall entries. | 180 | 143 | 51 | 1.02 |

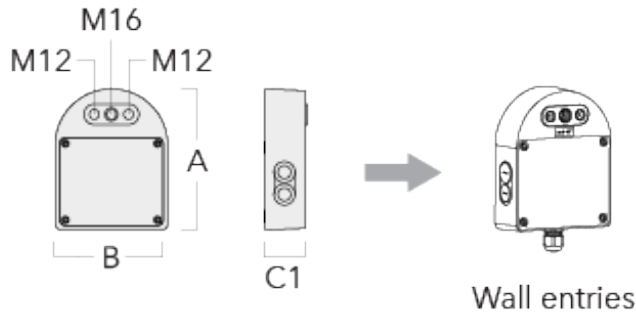

Pole clamp PC - Rotatable

| Description | Part ID | D1 | Weight (kg) |
|-------------------------------------------|----------|-------|-------------|
| PC2 76-89/60 Pole clamp, double (Ø 76-89) | 139-2703 | 76-89 | 1.00 |

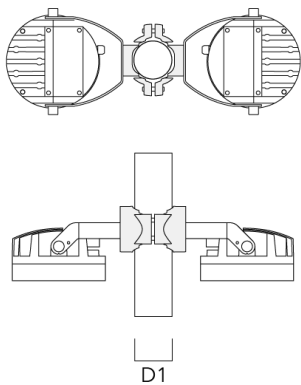

FLC240-CC LED

| Description | Part ID | D1 | Weight (kg) |
|-------------------------------------------|----------|-------|-------------|
| PC1 76-89/60 Pole clamp, single (Ø 76-89) | 139-2702 | 76-89 | 1.00 |

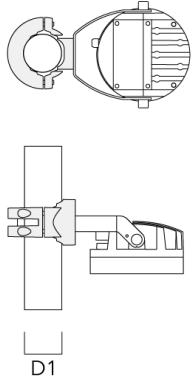

| | | | |
|-----------------------------------------------|----------|---------|------|
| PC2 102-114/60 Pole clamp, double (Ø 102-114) | 139-2707 | 102-114 | 1.20 |
|-----------------------------------------------|----------|---------|------|

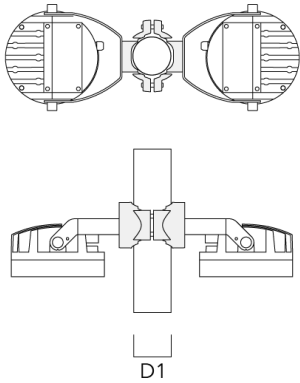

FLC240-CC LED

| Description | Part ID | D1 | Weight (kg) |
|--------------------------------------------------|----------|---------|-------------|
| PC1 102-114/60 Pole clamp, single (Ø 102-114) | 139-2706 | 102-114 | 1.20 |

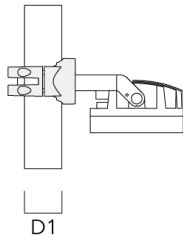
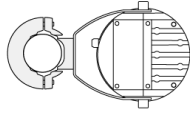

| | | | |
|--------------------------------------------------|----------|---------|------|
| PC2 114-133/60 Pole clamp, double (Ø 114-133) | 139-2709 | 114-133 | 1.40 |
|--------------------------------------------------|----------|---------|------|

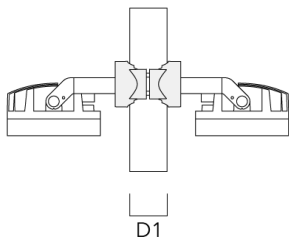
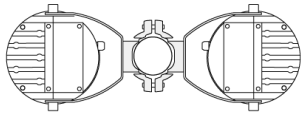

FLC240-CC LED

| Description | Part ID | D1 | Weight (kg) |
|--------------------------------------------------|----------|---------|-------------|
| PC1 114-133/60 Pole clamp, single (Ø 114-133) | 139-2708 | 114-133 | 1.40 |

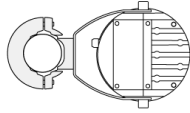

| | | | |
|--------------------------------------------|----------|--------|------|
| PC2 82-109/60 Pole camp, double (Ø 82-109) | 139-2705 | 82-109 | 1.10 |
|--------------------------------------------|----------|--------|------|

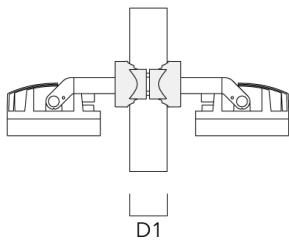
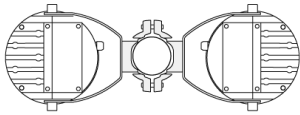

FLC240-CC LED

| Description | Part ID | D1 | Weight (kg) |
|--------------------------------------------|----------|--------|-------------|
| PC1 82-109/60 Pole camp, single (Ø 82-109) | 139-2704 | 82-109 | 1.10 |

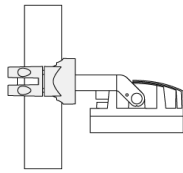
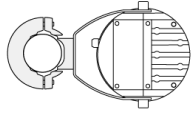

D1

FLC240-CC LED

Control

DMX Controller

| Description | Part ID |
|----------------|----------|
| DMX Controller | 400-0469 |

DMX Controller (smart)

| Description | Part ID | Additional information |
|------------------------|----------|-----------------------------------------------------------------------------------------------------------------------------------------|
| DMX Controller (smart) | 400-0470 | IP20. The Touch Panel is an untutive abd easy-to use keypad or one DMX universe. It can store up to 36 scences; alternatively, via |



FLC240-CC LED

DMX Controller - RDM ready

| Description | Part ID |
|----------------------------|----------|
| DMX Controller - RDM ready | 400-0471 |



DMX Splitter

| Description | Part ID |
|--------------|----------|
| DMX Splitter | 400-0473 |



FLC240-CC LED

DMX Booster Box

| Description | Part ID |
|-----------------|----------|
| DMX Booster Box | 400-0474 |



DMX Motion Sensor

| Description | Part ID |
|-------------------|----------|
| DMX Motion Sensor | 400-0478 |



FLC240-CC LED

DMX Termination Plug

| Description | Part ID |
|----------------------|----------|
| DMX Termination Plug | 400-0475 |



DMX Plug and Socket

| Description | Part ID |
|---------------------|----------|
| DMX Plug and Socket | 400-0479 |



FLC240-CC LED

DMX Combination Cable

| Description | Part ID |
|-----------------------|----------|
| DMX Combination Cable | 400-0480 |



DMX Wireless Repeater

| Description | Part ID |
|-----------------------|----------|
| DMX Wireless Repeater | 400-0477 |



FLC240-CC LED

DMX Wireless Transceiver

| Description | Part ID |
|--------------------------|----------|
| DMX Wireless Transceiver | 400-0476 |



DMX Controller (smart) - RDM ready

| Description | Part ID |
|------------------------------------|----------|
| DMX Controller (smart) - RDM ready | 400-0472 |

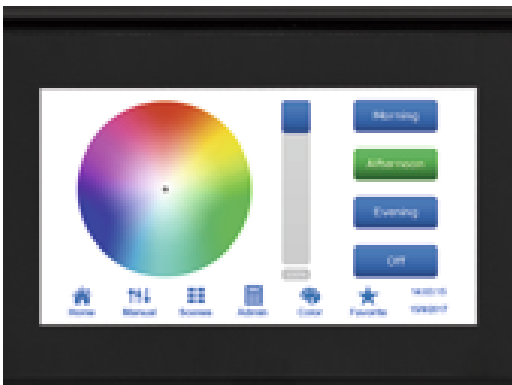

R2C Ready to Connect

| Description | Part ID |
|----------------------------|----------|
| R2C Ready to Connect (top) | 430-0019 |

WE-EF LIGHTING (Thailand) Co., Ltd.

57 Moo 5, Kingkaew Rd., Bangplee, 10540 Samutprakarn - Phone: +66 2 738 96 20 - Fax: +66 2 738 96 29

<https://we-ef.com/asia>

Subject to technical changes and errors. - Generated on 10/03/2025

DMX Wireless Antenna

| Description | Part ID |
|-----------------|----------|
| Antenna RF5dB | 430-0036 |
| Antenna RF1.8dB | 430-0018 |