

## FLC240-CC LED



### Description

RGBW/RGBA Colour Changer. IP66, Class I. Class II on request. IK07. Marine-grade, die-cast aluminium alloy. 5CE superior corrosion protection including PCS hardware. Silicone CCG® Controlled Compression Gasket. Safety glass lens. One cable gland. Second gland for through-wiring on request. Integral EC electronic converter, thermally separated. CAD-optimised optics for superior illumination and glare control. OLC® One LED Concept. Factory-installed LED circuit board with WE-EF Colour Boost Technology. With Colour Boost the targeted and selective control of individual channels or colours means that a higher power of the LEDs can be accessed than in total when all colours are simultaneously operated. The light output is thus maximized by targeted control of individual channels/colours.

DMX interface. For the M20 cable gland for network- and DMX-connection, WE-EF recommends a multi-core cable for DMX and power, "Power PUR-SR 3x1,5 + DMX".

|                    |                                |
|--------------------|--------------------------------|
| Weight             | 13.80 kg                       |
| Light distribution | linear spread, narrow beam [E] |
| Light source       | LED-24/96W - RGBA              |
| CRI                | 20                             |
| Power supply       | EC                             |
| LEDs               | 24                             |
| Rated input power  | 100 W                          |

### Nominal Lumen (lm)

|             |      |
|-------------|------|
| LED Lumen   | 275  |
| Total Lumen | 6600 |
| Tj          | 85   |

### Rated lumens (lm)

|             |       |
|-------------|-------|
| LED Lumen   | 193.1 |
| Total Lumen | 4635  |
| Ta          | 25    |

### WE-EF LEUCHTEN GmbH

Töpinger Straße 16, 29646 Bispingen, Germany - Phone: +49 5194 909-0  
info@we-ef.com - <https://we-ef.com>

Subject to technical changes and errors. - Generated on 02/07/2025

**FLC240-CC LED**

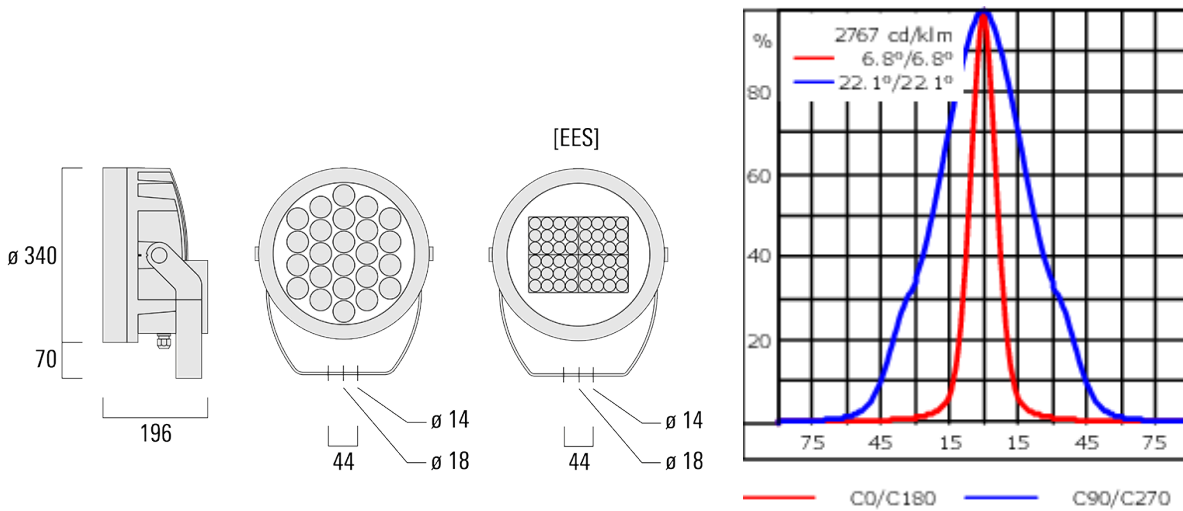

**Specifications**

**Material description**

|                      |   |
|----------------------|---|
| Body                 | Marine-grade, die-cast aluminium alloy  |
| Lens                 | Safety glass lens   |
| Colours              | <ul style="list-style-type: none"> <li><span style="display: inline-block; width: 20px; height: 10px; background-color: black; margin-right: 5px;"></span> RAL9004 Signal black</li> <li><span style="display: inline-block; width: 20px; height: 10px; background-color: #cccccc; margin-right: 5px;"></span> RAL9006 White aluminium</li> <li><span style="display: inline-block; width: 20px; height: 10px; background-color: #808080; margin-right: 5px;"></span> RAL9007 Grey aluminium</li> <li><span style="display: inline-block; width: 20px; height: 10px; background-color: #333333; margin-right: 5px;"></span> RAL7016 Anthracite grey</li> <li><span style="display: inline-block; width: 20px; height: 10px; background-color: #e0e0e0; margin-right: 5px;"></span> RAL9016 Traffic white</li> </ul> |
| Gasket               | Silicone CCG® Controlled Compression Gasket   |
| Fasteners            | PCS Polymer Coated Stainless Steel Hardware   |
| Ingress protection   | IP66  |
| Impact resistance    | IK07  |
| Corrosion resistance | 5CE   |
| Windage              | 0.090 m <sup>2</sup>  |

**Electrical description**

|                  |                        |
|------------------|------------------------|
| Power supply     | 220-240V / 50-60 Hz    |
| Driver / Ballast | DMX                    |
| Power factor     | > 0.9                  |
| Surge protection | 1/2 kV (optional SP10) |

**WE-EF LEUCHTEN GmbH**

Töpinger Straße 16, 29646 Bispingen, Germany - Phone: +49 5194 909-0

info@we-ef.com - <https://we-ef.com>

Subject to technical changes and errors. - Generated on 02/07/2025

**139-2141+139-1855**

**FLC240-CC LED**

**we-ef**

**Additional information**

---

|          |                        |
|----------|------------------------|
| Lifetime | Ta=25° L90B10 > 90000h |
|----------|------------------------|

---

**WE-EF LEUCHTEN GmbH**

Töpinger Straße 16, 29646 Bispingen, Germany - Phone: +49 5194 909-0  
info@we-ef.com - <https://we-ef.com>

Subject to technical changes and errors. - Generated on 02/07/2025

**Mounting Accessories**

**Floodlight mounting bracket TA**

| Description                                | Part ID  | A | C1  | D x L1   | Weight (kg) | D x S    |
|--|----------|---|-----|----------|-------------|----------|
| TA1 Mounting bracket, single* (Ø 76 x 200) | 147-0023 |   | 130 | 76 x 200 | 1.90        | 76 x 200 |

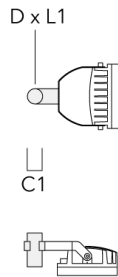

|  |          |  |     |          |      |          |
|--|----------|--|-----|----------|------|----------|
| TA2 Mounting bracket, double* (Ø 76 x 200) | 147-0024 |  | 130 | 76 x 200 | 1.90 | 76 x 200 |
|--|----------|--|-----|----------|------|----------|

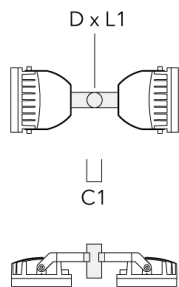

**FLC240-CC LED**

| Description                                 | Part ID  | A    | C1  | D x L1   | Weight (kg) | D x S    |
|---|----------|------|-----|----------|-------------|----------|
| TA2-L Mounting bracket, double (Ø 76 x 200) | 147-0105 | ±90° | 420 | 76 x 200 | 16.10       | 76 x 200 |



|   |          |      |     |          |       |          |
|---|----------|------|-----|----------|-------|----------|
| TA3 Mounting bracket, triple (Ø 89 x 200) | 147-0025 | ±90° | 650 | 89 x 200 | 17.90 | 89 x 200 |
|---|----------|------|-----|----------|-------|----------|



**FLC240-CC LED**

| Description                             | Part ID  | A    | C1  | D × L1   | Weight (kg) | D × S    |
|---|----------|------|-----|----------|-------------|----------|
| TA4 Mounting bracket, quad (Ø 89 x 200) | 147-0099 | ±90° | 650 | 89 x 200 | 20.80       | 89 x 200 |



|  |          |  |     |           |      |           |
|--|----------|--|-----|-----------|------|-----------|
| TA1 Mounting bracket, single (Ø 108 x 200) | 147-0096 |  | 130 | 108 x 200 | 7.50 | 108 x 200 |
|--|----------|--|-----|-----------|------|-----------|



**FLC240-CC LED**

| Description                                | Part ID  | A | C1  | D × L1    | Weight (kg) | D × S     |
|--|----------|---|-----|-----------|-------------|-----------|
| TA2 Mounting bracket, double (Ø 108 x 200) | 147-0097 |   | 130 | 108 x 200 | 7.50        | 108 x 200 |

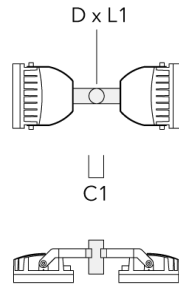

|  |          |      |     |           |       |           |
|--|----------|------|-----|-----------|-------|-----------|
| TA2-L Mounting bracket, double (Ø 108 x 200) | 147-0148 | ±90° | 420 | 108 x 200 | 20.20 | 108 x 200 |
|--|----------|------|-----|-----------|-------|-----------|

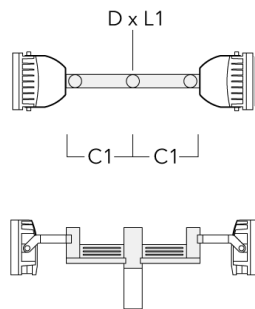

**FLC240-CC LED**

| Description                                | Part ID  | A    | C1  | D x L1    | Weight (kg) | D x S     |
|--|----------|------|-----|-----------|-------------|-----------|
| TA3 Mounting bracket, triple (Ø 108 x 200) | 147-0098 | ±90° | 650 | 108 x 200 | 24.20       | 108 x 200 |

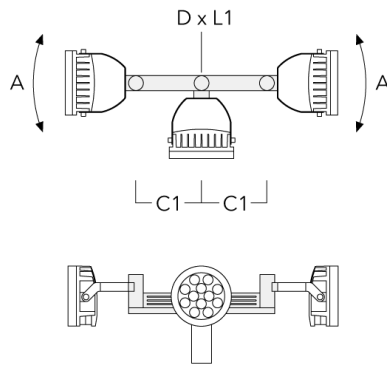

|  |          |      |     |           |       |           |
|--|----------|------|-----|-----------|-------|-----------|
| TA4 Mounting bracket, quad (Ø 108 x 200) | 147-0100 | ±90° | 650 | 108 x 200 | 24.20 | 108 x 200 |
|--|----------|------|-----|-----------|-------|-----------|

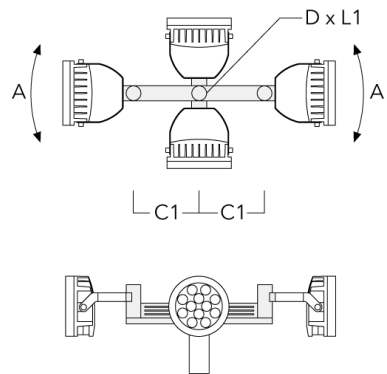



**FLC240-CC LED**

**Pole clamp TS**

| Description                            | Part ID  | D1    | Weight (kg) | D     |
|--|----------|-------|-------------|-------|
| TS1-2/M12 Pole clamp, single (Ø 76-89) | 147-0543 | 76-89 | 1.40        | 76-89 |

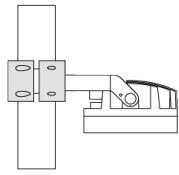
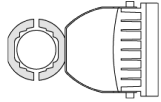

D1

|  |          |         |      |         |
|--|----------|---------|------|---------|
| TS1-2/M12 Pole clamp, single (Ø 102-114) | 147-0526 | 102-114 | 1.50 | 102-114 |
|--|----------|---------|------|---------|

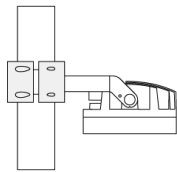
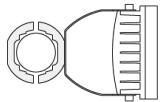

D1

**FLC240-CC LED**

| Description                              | Part ID  | D1      | Weight (kg) | D       |
|--|----------|---------|-------------|---------|
| TS1-2/M12 Pole clamp, single (Ø 114-133) | 147-0544 | 114-133 | 1.70        | 114-133 |

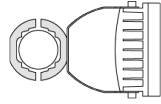

D1

|  |          |       |      |       |
|--|----------|-------|------|-------|
| TS2-2/M12 Pole clamp, double (Ø 76-89) | 147-0545 | 76-89 | 1.40 | 76-89 |
|--|----------|-------|------|-------|

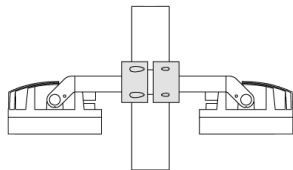
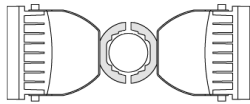

D1

**FLC240-CC LED**

| Description                              | Part ID  | D1      | Weight (kg) | D       |
|--|----------|---------|-------------|---------|
| TS2-2/M12 Pole clamp, double (Ø 102-114) | 147-0527 | 102-114 | 1.50        | 102-114 |

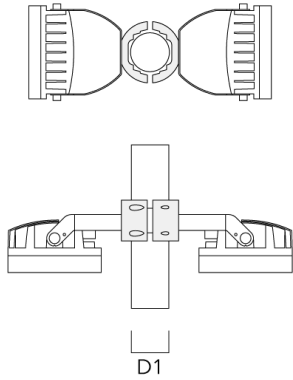

|  |          |         |      |         |
|--|----------|---------|------|---------|
| TS2-2/M12 Pole clamp, double (Ø 114-133) | 147-0546 | 114-133 | 1.60 | 114-133 |
|--|----------|---------|------|---------|

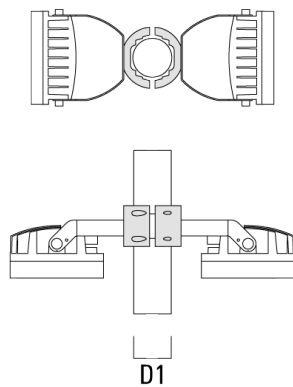

## FLC240-CC LED

## Pole clamp PC

| Description                               | Part ID  | D1    | Weight (kg) |
|---|----------|-------|-------------|
| PC2 76-89/60 Pole clamp, double (Ø 76-89) | 139-2703 | 76-89 | 1.00        |



|   |          |       |      |
|---|----------|-------|------|
| PC1 76-89/60 Pole clamp, single (Ø 76-89) | 139-2702 | 76-89 | 1.00 |
|---|----------|-------|------|



**FLC240-CC LED**

| Description                                      | Part ID  | D1      | Weight (kg) |
|--|----------|---------|-------------|
| PC2 102-114/60 Pole clamp, double<br>(Ø 102-114) | 139-2707 | 102-114 | 1.20        |



|  |          |         |      |
|--|----------|---------|------|
| PC1 102-114/60 Pole clamp, single<br>(Ø 102-114) | 139-2706 | 102-114 | 1.20 |
|--|----------|---------|------|



**FLC240-CC LED**

| Description                                      | Part ID  | D1      | Weight (kg) |
|--|----------|---------|-------------|
| PC2 114-133/60 Pole clamp, double<br>(Ø 114-133) | 139-2709 | 114-133 | 1.40        |



|  |          |         |      |
|--|----------|---------|------|
| PC1 114-133/60 Pole clamp, single<br>(Ø 114-133) | 139-2708 | 114-133 | 1.40 |
|--|----------|---------|------|



**FLC240-CC LED**

| Description                                | Part ID  | D1     | Weight (kg) |
|--|----------|--------|-------------|
| PC2 82-109/60 Pole camp, double (Ø 82-109) | 139-2705 | 82-109 | 1.10        |



|  |          |        |      |
|--|----------|--------|------|
| PC1 82-109/60 Pole camp, single (Ø 82-109) | 139-2704 | 82-109 | 1.10 |
|--|----------|--------|------|



## Optical Accessories

### Wallwash lens

| Description      | Part ID  | Additional information                       | C1  |
|------------------|----------|--|-----|
| IO-20-FLC240-LED | 139-1854 | for symmetric [M] medium beam luminaire only | 289 |

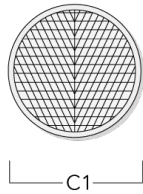

### Linear spread lens

| Description               | Part ID  | C1  |
|---------------------------|----------|-----|
| Linear spread lens IO-180 | 139-1855 | 289 |





**FLC240-CC LED**

**Snoot**

| Description   | Part ID  | A   | C1  |
|---------------|----------|-----|-----|
| ET-FLC240-LED | 139-1859 | 200 | 346 |

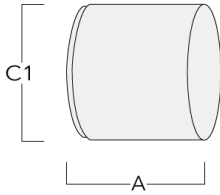

**Glare shield**

| Description   | Part ID  | A   | C1  |
|---------------|----------|-----|-----|
| ES-FLC240-LED | 139-1858 | 200 | 346 |

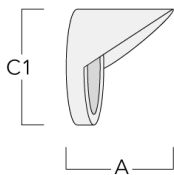

**FLC240-CC LED**

**Flood lens**

| Description       | Part ID  | C1  |
|-------------------|----------|-----|
| IO-360-FLC240-LED | 139-1856 | 289 |



**Honeycomb louvre**

| Description                     | Part ID  | C1  | H1 |
|---------------------------------|----------|-----|----|
| IW-FLC240-CC LED - [E][EE][EES] | 139-1857 | 279 |    |



**FLC240-CC LED**

---

| Description         | Part ID  | C1  | H1  |
|---------------------|----------|-----|-----|
| IW-FLC24_EES-CC LED | 139-2433 | 205 | 160 |

---

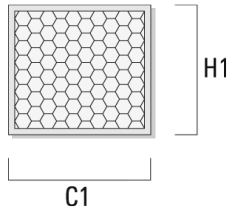

**FLC240-CC LED**

**Control**

**DMX Controller**

| Description    | Part ID  |
|----------------|----------|
| DMX Controller | 400-0469 |

**DMX Controller (smart)**

| Description            | Part ID  | Additional information  |
|------------------------|----------|---|
| DMX Controller (smart) | 400-0470 | IP20. The Touch Panel is an intuitive and easy-to-use keypad or one DMX universe. It can store up to 36 scenes; alternatively, via .... |



## FLC240-CC LED

## DMX Booster Box

| Description     | Part ID  |
|-----------------|----------|
| DMX Booster Box | 400-0474 |



## DMX Motion Sensor

| Description       | Part ID  |
|-------------------|----------|
| DMX Motion Sensor | 400-0478 |



**FLC240-CC LED**

**DMX Termination Plug**

---

| Description          | Part ID  |
|----------------------|----------|
| DMX Termination Plug | 400-0475 |

---



---

**DMX Plug and Socket**

---

| Description         | Part ID  |
|---------------------|----------|
| DMX Plug and Socket | 400-0479 |

---



**FLC240-CC LED**

**DMX Combination Cable**

---

| Description           | Part ID  |
|-----------------------|----------|
| DMX Combination Cable | 400-0480 |

---



---

**DMX Wireless Repeater**

---

| Description           | Part ID  |
|-----------------------|----------|
| DMX Wireless Repeater | 400-0477 |

---



**FLC240-CC LED**

**DMX Wireless Transceiver**

| Description              | Part ID  |
|--------------------------|----------|
| DMX Wireless Transceiver | 400-0476 |



**R2C Ready to Connect**

| Description                | Part ID  |
|----------------------------|----------|
| R2C Ready to Connect (top) | 430-0019 |

**DMX Wireless Antenna**

| Description     | Part ID  |
|-----------------|----------|
| Antenna RF5dB   | 430-0036 |
| Antenna RF1.8dB | 430-0018 |