

139-2144

FLC260-CC LED

we-ef



Description

RGBW/RGBA Colour Changer. IP66, Class I. Class II on request. IK07. Marine-grade, die-cast aluminium alloy. 5CE superior corrosion protection including PCS hardware. Silicone CCG® Controlled Compression Gasket. Safety glass lens. One cable gland. Second gland for through-wiring on request. Integral EC electronic converter, thermally separated. CAD-optimised optics for superior illumination and glare control. OLC® One LED Concept. Factory-installed LED circuit board with WE-EF Colour Boost Technology. With Colour Boost the targeted and selective control of individual channels or colours means that a higher power of the LEDs can be accessed than in total when all colours are simultaneously operated. The light output is thus maximized by targeted control of individual channels/colours.

DMX interface. For the M20 cable gland for network- and DMX-connection, WE-EF recommends a multi-core cable for DMX and power, "Power PUR-SR 3x1,5 + DMX".

| | |
|--------------------|----------------------------|
| Weight | 18.00 kg |
| Light distribution | symmetric, narrow beam [E] |
| Light source | LED-36/144W - RGBA |
| CRI | 20 |
| Power supply | EC |
| LEDs | 36 |
| Rated input power | 150 W |

Nominal Lumen (lm)

| | |
|-------------|------|
| LED Lumen | 275 |
| Total Lumen | 9900 |
| Tj | 85 |

Rated lumens (lm)

| | |
|-------------|--------|
| LED Lumen | 211.9 |
| Total Lumen | 7628.1 |
| Ta | 25 |

WE-EF LEUCHTEN GmbH

Töpinger Straße 16, 29646 Bispingen, Germany - Phone: +49 5194 909-0
info@we-ef.com - <https://we-ef.com>

Subject to technical changes and errors. - Generated on 10/03/2025

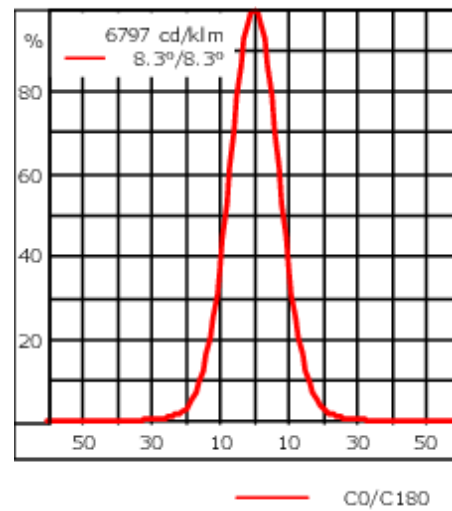
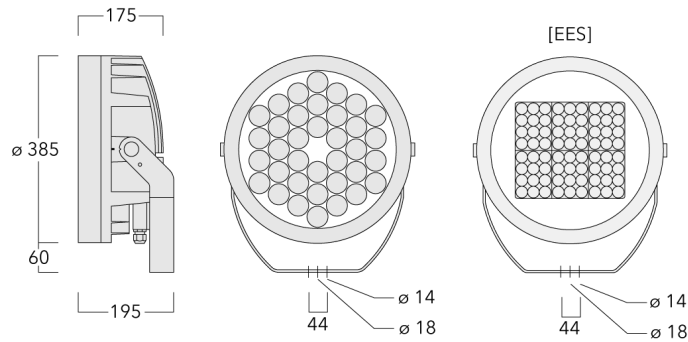

Specifications

Material description

| | |
|----------------------|---|
| Body | Marine-grade, die-cast aluminium alloy |
| Lens | Safety glass lens |
| Colours | <ul style="list-style-type: none"> RAL9004 Signal black RAL9006 White aluminium RAL9007 Grey aluminium RAL7016 Anthracite grey RAL9016 Traffic white |
| Gasket | Silicone CCG® Controlled Compression Gasket |
| Fasteners | PCS Polymer Coated Stainless Steel Hardware |
| Ingress protection | IP66 |
| Impact resistance | IK07 |
| Corrosion resistance | 5CE |
| Windage | 0.116 m ² |

Electrical description

| | |
|------------------|------------------------|
| Power supply | 220-240V / 50-60 Hz |
| Driver / Ballast | DMX |
| Power factor | > 0.9 |
| Surge protection | 1/2 kV (optional SP10) |

Additional information

| | |
|-------------------------|------------------------|
| Lifetime | Ta=25° L90B10 > 90000h |
| Energy efficiency class | G (Light source) |

WE-EF LEUCHTEN GmbH

Töpinger Straße 16, 29646 Bispingen, Germany - Phone: +49 5194 909-0
 info@we-ef.com - <https://we-ef.com>

Subject to technical changes and errors. - Generated on 10/03/2025

Optical Accessories

Flood lens

| Description | Part ID | C1 |
|-------------------|----------|-----|
| IO-360-FLC260-LED | 139-1862 | 332 |

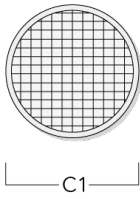

Honeycomb louvre

| Description | Part ID | C1 | H1 |
|---------------------------------|----------|-----|----|
| IW-03-FLC260-LED - [E][EE][EES] | 139-1863 | 324 | |

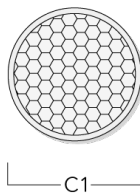

| Description | Part ID | C1 | H1 |
|---------------------|----------|-----|-----|
| IW-FLC26_EES-CC LED | 139-2434 | 232 | 209 |

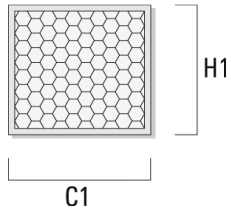

Linear spread lens

| Description | Part ID | C1 |
|----------------------|----------|-----|
| IO-180-FLC260-CC LED | 139-1861 | 332 |

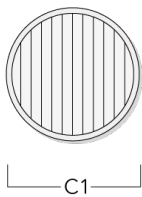

Wallwash lens

| Description | Part ID | C1 |
|---------------------|----------|-----|
| IO-20-FLC260-CC LED | 139-1860 | 332 |



Snoot

| Description | Part ID | A | C1 |
|---------------|----------|-----|-----|
| ET-FLC260-LED | 139-1865 | 222 | 393 |

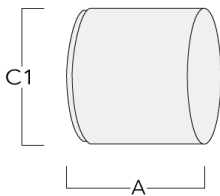

Glare shield

| Description | Part ID | A | C1 |
|---------------|----------|-----|-----|
| ES-FLC260-LED | 139-1864 | 222 | 393 |

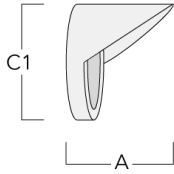

Mounting Accessories

Pole clamp TS

| Description | Part ID | D1 | Weight (kg) | D |
|--|----------|-------|-------------|-------|
| TS1-2/M12 Pole clamp, single (Ø 76-89) | 147-0543 | 76-89 | 1.40 | 76-89 |

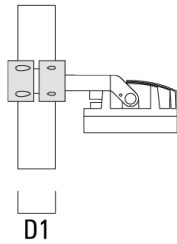
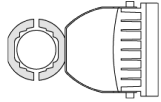

| | | | | |
|--|----------|---------|------|---------|
| TS1-2/M12 Pole clamp, single (Ø 114-133) | 147-0544 | 114-133 | 1.70 | 114-133 |
|--|----------|---------|------|---------|

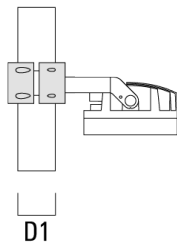
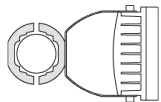

FLC260-CC LED

| Description | Part ID | D1 | Weight (kg) | D |
|--|----------|-------|-------------|-------|
| TS2-2/M12 Pole clamp, double (Ø 76-89) | 147-0545 | 76-89 | 1.40 | 76-89 |

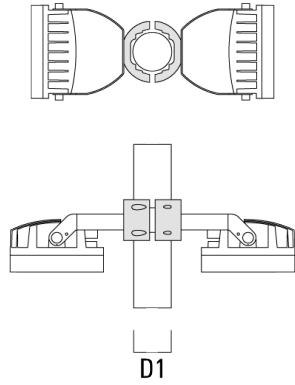

| | | | | |
|--|----------|---------|------|---------|
| TS2-2/M12 Pole clamp, double (Ø 114-133) | 147-0546 | 114-133 | 1.60 | 114-133 |
|--|----------|---------|------|---------|

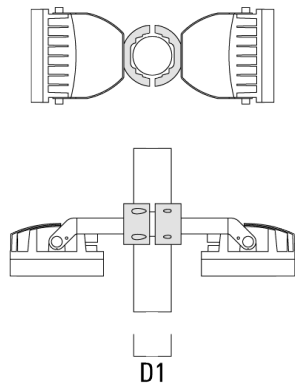

Floodlight mounting bracket TA

| Description | Part ID | C1 | D × L1 | Weight (kg) | D × S |
|--|----------|-----|----------|-------------|----------|
| TA1 Mounting bracket, single* (Ø 76 x 200) | 147-0023 | 130 | 76 x 200 | 1.90 | 76 x 200 |

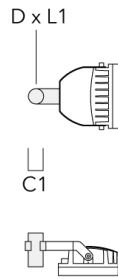

Pole clamp PC

| Description | Part ID | D1 | Weight (kg) |
|---|----------|-------|-------------|
| PC2 76-89/60 Pole clamp, double (Ø 76-89) | 139-2703 | 76-89 | 1.00 |

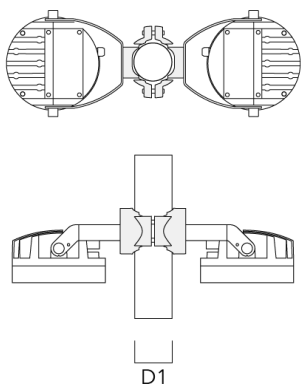

FLC260-CC LED

| Description | Part ID | D1 | Weight (kg) |
|---|----------|-------|-------------|
| PC1 76-89/60 Pole clamp, single (Ø 76-89) | 139-2702 | 76-89 | 1.00 |

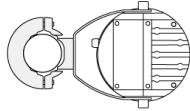

| | | | |
|---|----------|---------|------|
| PC2 102-114/60 Pole clamp, double (Ø 102-114) | 139-2707 | 102-114 | 1.20 |
|---|----------|---------|------|

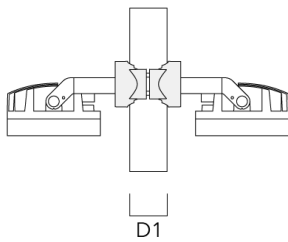
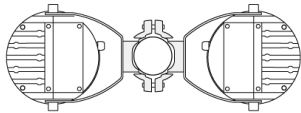

FLC260-CC LED

| Description | Part ID | D1 | Weight (kg) |
|--|----------|---------|-------------|
| PC1 102-114/60 Pole clamp, single (Ø 102-114) | 139-2706 | 102-114 | 1.20 |

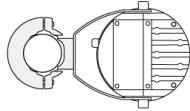

| | | | |
|--|----------|---------|------|
| PC2 114-133/60 Pole clamp, double (Ø 114-133) | 139-2709 | 114-133 | 1.40 |
|--|----------|---------|------|



FLC260-CC LED

| Description | Part ID | D1 | Weight (kg) |
|--|----------|---------|-------------|
| PC1 114-133/60 Pole clamp, single (Ø 114-133) | 139-2708 | 114-133 | 1.40 |



| | | | |
|--|----------|--------|------|
| PC2 82-109/60 Pole camp, double (Ø 82-109) | 139-2705 | 82-109 | 1.10 |
|--|----------|--------|------|



139-2144

FLC260-CC LED

we-ef

| Description | Part ID | D1 | Weight (kg) |
|--|----------|--------|-------------|
| PC1 82-109/60 Pole camp, single (Ø 82-109) | 139-2704 | 82-109 | 1.10 |

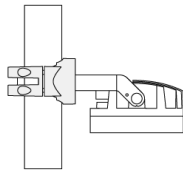

D1

WE-EF LEUCHTEN GmbH

Töpinger Straße 16, 29646 Bispingen, Germany - Phone: +49 5194 909-0
info@we-ef.com - <https://we-ef.com>

Subject to technical changes and errors. - Generated on 10/03/2025

Control**DMX Controller**

| Description | Part ID |
|----------------|----------|
| DMX Controller | 400-0469 |

DMX Controller (smart)

| Description | Part ID | Additional information |
|------------------------|----------|---|
| DMX Controller (smart) | 400-0470 | IP20. The Touch Panel is an intuitive and easy-to-use keypad or one DMX universe. It can store up to 36 scenes; alternatively, via |



DMX Controller - RDM ready

| Description | Part ID |
|----------------------------|----------|
| DMX Controller - RDM ready | 400-0471 |

**DMX Splitter**

| Description | Part ID |
|--------------|----------|
| DMX Splitter | 400-0473 |



139-2144

FLC260-CC LED

we-ef

DMX Booster Box

| Description | Part ID |
|-----------------|----------|
| DMX Booster Box | 400-0474 |



DMX Motion Sensor

| Description | Part ID |
|-------------------|----------|
| DMX Motion Sensor | 400-0478 |



WE-EF LEUCHTEN GmbH

Töpinger Straße 16, 29646 Bispingen, Germany - Phone: +49 5194 909-0
info@we-ef.com - <https://we-ef.com>

Subject to technical changes and errors. - Generated on 10/03/2025

DMX Termination Plug

| Description | Part ID |
|----------------------|----------|
| DMX Termination Plug | 400-0475 |



DMX Plug and Socket

| Description | Part ID |
|---------------------|----------|
| DMX Plug and Socket | 400-0479 |



DMX Combination Cable

| Description | Part ID |
|-----------------------|----------|
| DMX Combination Cable | 400-0480 |



DMX Wireless Repeater

| Description | Part ID |
|-----------------------|----------|
| DMX Wireless Repeater | 400-0477 |



DMX Wireless Transceiver

| Description | Part ID |
|--------------------------|----------|
| DMX Wireless Transceiver | 400-0476 |

**DMX Controller (smart) - RDM ready**

| Description | Part ID |
|------------------------------------|----------|
| DMX Controller (smart) - RDM ready | 400-0472 |

**DMX Wireless Antenna**

| Description | Part ID |
|---------------|----------|
| Antenna RF5dB | 430-0036 |

WE-EF LEUCHTEN GmbH

Töpinger Straße 16, 29646 Bispingen, Germany - Phone: +49 5194 909-0
 info@we-ef.com - <https://we-ef.com>

Subject to technical changes and errors. - Generated on 10/03/2025

139-2144

FLC260-CC LED

we-ef

| Description | Part ID |
|-----------------|----------|
| Antenna RF1.8dB | 430-0018 |

WE-EF LEUCHTEN GmbH

Töpinger Straße 16, 29646 Bispingen, Germany - Phone: +49 5194 909-0
info@we-ef.com - <https://we-ef.com>

Subject to technical changes and errors. - Generated on 10/03/2025