



### Description

Changement de couleurs RGBW. IP66. Classe I. Classe II sur demande. IK07. Corps en fonte d'aluminium. Visserie inox avec traitement PCS. Protection contre la corrosion 5CE. Joint silicone CCG®. Verre de sécurité. LED contrôlables par système DMX.

Technologie sans fil DMX Wireless disponible.

Poids	18.00 kg
Distribution de la lumière	wallwash
Source lumineuse	LED-36/144W - RGBA
IRC	20
Alimentation électrique	ballast électronique
LEDs	36
Rated input power	150 W
<b>Flux lumineux nominal (lm)</b>	
LED Lumen	275
Total Lumen	9900
Tj	85
<b>Rated lumens (lm)</b>	
LED Lumen	175.2
Total Lumen	6306.6
Ta	25

### WE-EF Switzerland AG

Himmelrichstrasse 6, 6003 Luzern - Téléphone: +41 22 752 49 94

info.switzerland@we-ef.com - [https://we-ef.com/ch\\_fr](https://we-ef.com/ch_fr)

Sous réserve de modifications techniques et d'erreurs. - Généré le 10/03/2025

## FLC260-CC LED

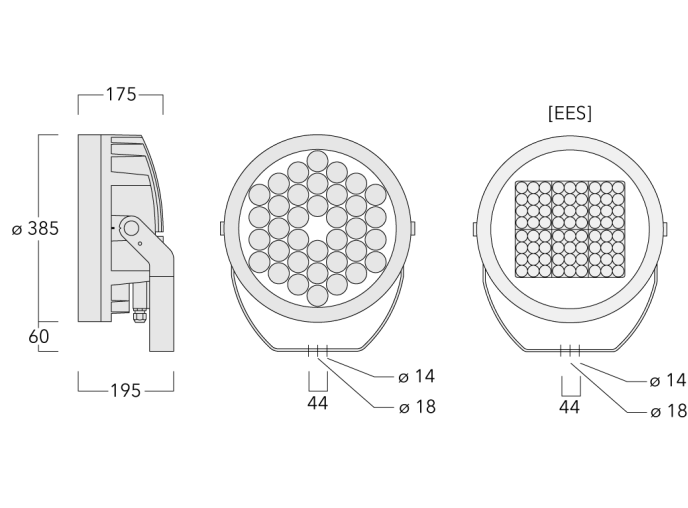

## Spécifications

## Description du matériel

Corps	Corps en fonte d'aluminium
Lentille	Verre de sécurité
Couleurs	<div style="display: flex; align-items: center;"> <div style="width: 20px; height: 15px; background-color: black; margin-right: 5px;"></div> <span>RAL9004 Noir de sécurité</span> </div> <div style="display: flex; align-items: center;"> <div style="width: 20px; height: 15px; background-color: gray; margin-right: 5px;"></div> <span>RAL9007 Aluminium gris</span> </div> <div style="display: flex; align-items: center;"> <div style="width: 20px; height: 15px; background-color: darkgray; margin-right: 5px;"></div> <span>RAL7016 Gris anthracite</span> </div> <div style="display: flex; align-items: center;"> <div style="width: 20px; height: 15px; background-color: lightgray; margin-right: 5px;"></div> <span>RAL9016 Blanc signalisation</span> </div>
Joint	Joint silicone CCG®
Visserie	PCS Polymer Coated Stainless Steel Hardware
IP	IP66
IK	IK07
Protection contre la corrosion	5CE
Surface exposée au vent	0.116 m <sup>2</sup>

## Description électrique

Alimentation électrique	220-240V / 50-60 Hz
Driver	DMX
Power factor	> 0.9

## WE-EF Switzerland AG

Himmelrichstrasse 6, 6003 Luzern - Téléphone: +41 22 752 49 94

info.switzerland@we-ef.com - [https://we-ef.com/ch\\_fr](https://we-ef.com/ch_fr)

Sous réserve de modifications techniques et d'erreurs. - Généré le 10/03/2025

**139-2145+139-1860**

**FLC260-CC LED**

**we-ef**

### **Informations complémentaires**

---

Durée de vie Ta=25° L90B10 > 90000h

Classe d'efficacité  
énergétique G

---

**WE-EF Switzerland AG**

Himmelrichstrasse 6, 6003 Luzern - Téléphone: +41 22 752 49 94

info.switzerland@we-ef.com - [https://we-ef.com/ch\\_fr](https://we-ef.com/ch_fr)

Sous réserve de modifications techniques et d'erreurs. - Généré le 10/03/2025

**Accessoires Optiques****Lentille élargissante**

Description	Référence	C1
IO-360-FLC260-LED	139-1862	332

**Grille nid d'abeille**

Description	Référence	C1	H1
IW-03-FLC260-LED - [E][EE][EES]	139-1863	324	

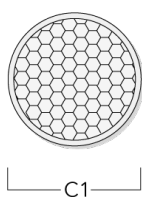

## FLC260-CC LED

Description	Référence	C1	H1
IW-FLC26_EES-CC LED	139-2434	232	209

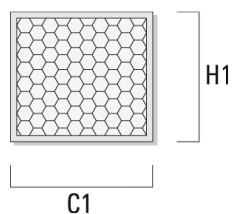

## Lentille ovalisante

Description	Référence	C1
IO-180-FLC260-CC LED	139-1861	332

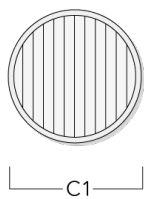

## FLC260-CC LED

## Lentille rasante

Description	Référence	C1
IO-20-FLC260-CC LED	139-1860	332



## Canon anti-éblouissement

Description	Référence	A	C1
ET-FLC260-LED	139-1865	222	393

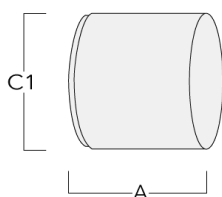

**FLC260-CC LED**

**Visière**

---

Description	Référence	A	C1
ES-FLC260-LED	139-1864	222	393

---

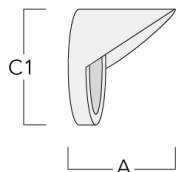

## Accessoires d'installation

## Collier pour mâts TS

Description	Référence	D1	Poids (kg)	D
TS1-2/M12 collier simple pour tube (Ø 76-89)	147-0543	76-89	1.40	76-89

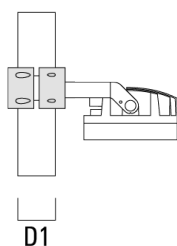
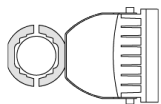

TS1-2/M12 collier simple pour tube (Ø 114-133)	147-0544	114-133	1.70	114-133
---	----------	---------	------	---------

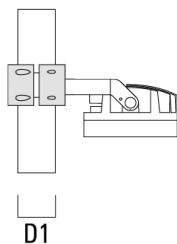
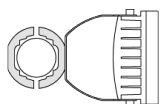



**FLC260-CC LED**

Description	Référence	D1	Poids (kg)	D
TS2-2/M12 collier double pour tube (Ø 76-89)	147-0545	76-89	1.40	76-89

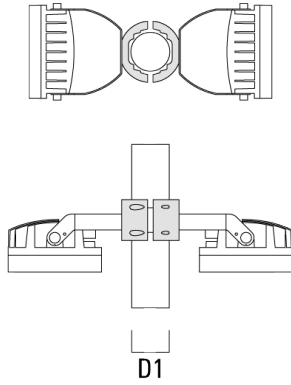

TS2-2/M12 collier double pour tube (Ø 114-133)	147-0546	114-133	1.60	114-133
---	----------	---------	------	---------

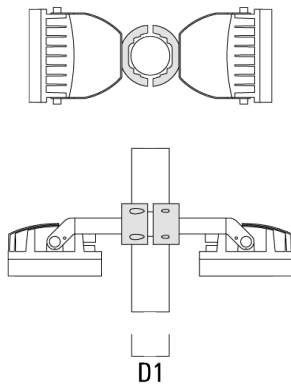

## FLC260-CC LED

## Traverse pour mâts

Description	Référence	C1	D × L1	Poids (kg)	D × S
TA1 traverse simple (Ø 76 x 200)	147-0023	130	76 x 200	1.90	76 x 200

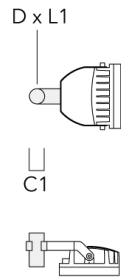

## Collier pour mâts PC

Description	Référence	D1	Poids (kg)
PC2 76-89/60 collier double pour tube (Ø 76-89)	139-2703	76-89	1.00

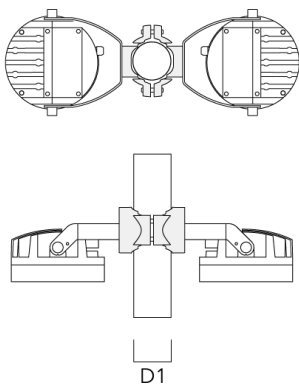

## FLC260-CC LED

Description	Référence	D1	Poids (kg)
PC1 76-89/60 collier simple (Ø 76-89)	139-2702	76-89	1.00



PC2 102-114/60 collier double pour tube (Ø 102-114)	139-2707	102-114	1.20
---	----------	---------	------

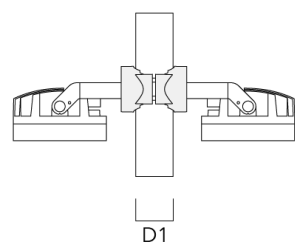

## FLC260-CC LED

Description	Référence	D1	Poids (kg)
PC1 102-114/60 collier simple (Ø 102-114)	139-2706	102-114	1.20



PC2 114-133/60 collier double pour tube (Ø 114-133)	139-2709	114-133	1.40
---	----------	---------	------

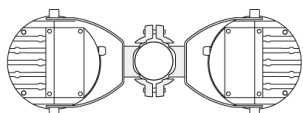

## FLC260-CC LED

Description	Référence	D1	Poids (kg)
PC1 114-133/60 collier simple (Ø 114-133)	139-2708	114-133	1.40



PC2 82-109/60 collier double pour tube (Ø 82-109)	139-2705	82-109	1.10
---	----------	--------	------



## FLC260-CC LED

Description	Référence	D1	Poids (kg)
PC1 82-109/60 collier simple (Ø 82-109)	139-2704	82-109	1.10



## FLC260-CC LED

**Control****DMX Controller**

Description	Référence
DMX Controller	400-0469

**DMX Controller (smart)**

Description	Référence	Informations complémentaires
DMX Controller (smart)	400-0470	IP20. The Touch Panel is an intuitive and easy-to-use keypad or one DMX universe. It can store up to 36 scenes; alternatively, via ....



## FLC260-CC LED

## DMX Controller - RDM ready

Description	Référence
DMX Controller - RDM ready	400-0471



## DMX Splitter

Description	Référence
DMX Splitter	400-0473



## WE-EF Switzerland AG

Himmelrichstrasse 6, 6003 Luzern - Téléphone: +41 22 752 49 94

info.switzerland@we-ef.com - [https://we-ef.com/ch\\_fr](https://we-ef.com/ch_fr)

Sous réserve de modifications techniques et d'erreurs. - Généré le 10/03/2025



**FLC260-CC LED****DMX Booster Box**

Description	Référence
DMX Booster Box	400-0474

**DMX Motion Sensor**

Description	Référence
DMX Motion Sensor	400-0478

**WE-EF Switzerland AG**

Himmelrichstrasse 6, 6003 Luzern - Téléphone: +41 22 752 49 94

info.switzerland@we-ef.com - [https://we-ef.com/ch\\_fr](https://we-ef.com/ch_fr)

Sous réserve de modifications techniques et d'erreurs. - Généré le 10/03/2025

**FLC260-CC LED**

**DMX Termination Plug**

---

Description	Référence
DMX Termination Plug	400-0475

---



---

**DMX Plug and Socket**

---

Description	Référence
DMX Plug and Socket	400-0479

---



**FLC260-CC LED**

**DMX Combination Cable**

---

Description	Référence
DMX Combination Cable	400-0480

---



---

**DMX Wireless Repeater**

---

Description	Référence
DMX Wireless Repeater	400-0477

---



**FLC260-CC LED****DMX Wireless Transceiver**

Description	Référence
DMX Wireless Transceiver	400-0476

**DMX Controller (smart) - RDM ready**

Description	Référence
DMX Controller (smart) - RDM ready	400-0472

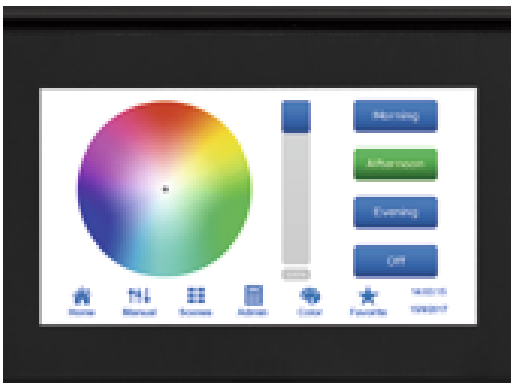
**DMX Wireless Antenna**

Description	Référence
Antenne RF 5dB	430-0036

**WE-EF Switzerland AG**

Himmelrichstrasse 6, 6003 Luzern - Téléphone: +41 22 752 49 94

info.switzerland@we-ef.com - [https://we-ef.com/ch\\_fr](https://we-ef.com/ch_fr)

Sous réserve de modifications techniques et d'erreurs. - Généré le 10/03/2025

**139-2145+139-1860**

**FLC260-CC LED**

**we-ef**

Description	Référence
Antenne RF1.8 dB	430-0018

**WE-EF Switzerland AG**

Himmelrichstrasse 6, 6003 Luzern - Téléphone: +41 22 752 49 94

info.switzerland@we-ef.com - [https://we-ef.com/ch\\_fr](https://we-ef.com/ch_fr)

Sous réserve de modifications techniques et d'erreurs. - Généré le 10/03/2025