



### Description

RGBW/RGBA Colour Changer. IP66, Class I. Class II on request. IK07. Marine-grade, die-cast aluminium alloy. 5CE superior corrosion protection including PCS hardware. Silicone CCG® Controlled Compression Gasket. Safety glass lens. One cable gland. Second gland for through-wiring on request. Integral EC electronic converter, thermally separated. CAD-optimised optics for superior illumination and glare control. OLC® One LED Concept. Factory-installed LED circuit board with WE-EF Colour Boost Technology. With Colour Boost the targeted and selective control of individual channels or colours means that a higher power of the LEDs can be accessed than in total when all colours are simultaneously operated. The light output is thus maximized by targeted control of individual channels/colours.

DMX interface. For the M20 cable gland for network- and DMX-connection, WE-EF recommends a multi-core cable for DMX and power, "Power PUR-SR 3x1,5 + DMX".

Weight	18.00 kg
Light distribution	linear spread, narrow beam [E]
Light source	LED-36/144W - RGBA
CRI	20
Power supply	EC
LEDs	36
Rated input power	150 W

### Nominal Lumen (lm)

LED Lumen	275
Total Lumen	9900
Tj	85

### Rated lumens (lm)

LED Lumen	193.1
Total Lumen	6952.5
Ta	25

**FLC260-CC LED**

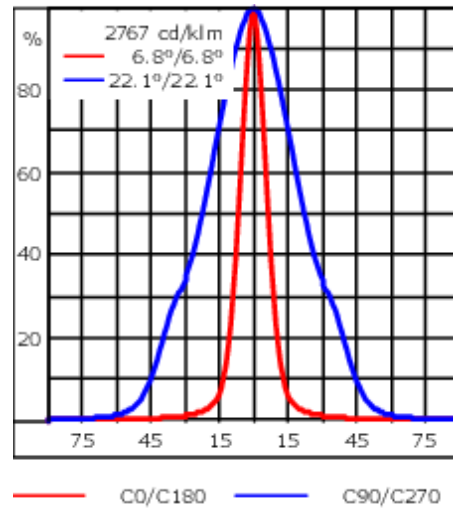
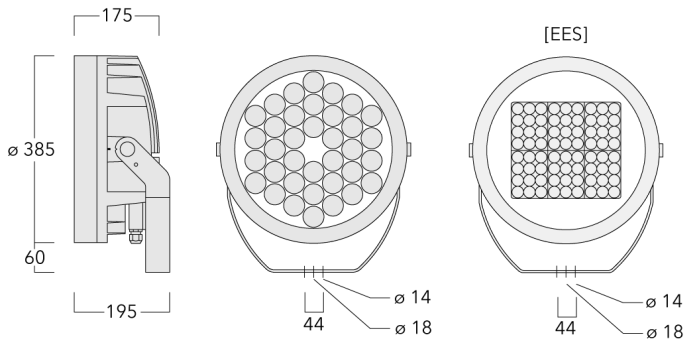

**Specifications**

**Material description**

Body	Marine-grade, die-cast aluminium alloy
Lens	Safety glass lens
Colours	<ul style="list-style-type: none"> <li><span style="display: inline-block; width: 20px; height: 10px; background-color: black; margin-right: 5px;"></span> RAL9004 Signal black</li> <li><span style="display: inline-block; width: 20px; height: 10px; background-color: #cccccc; margin-right: 5px;"></span> RAL9006 White aluminium</li> <li><span style="display: inline-block; width: 20px; height: 10px; background-color: #808080; margin-right: 5px;"></span> RAL9007 Grey aluminium</li> <li><span style="display: inline-block; width: 20px; height: 10px; background-color: #333333; margin-right: 5px;"></span> RAL7016 Anthracite grey</li> <li><span style="display: inline-block; width: 20px; height: 10px; background-color: #e0e0e0; margin-right: 5px;"></span> RAL9016 Traffic white</li> </ul>
Gasket	Silicone CCG® Controlled Compression Gasket
Fasteners	PCS Polymer Coated Stainless Steel Hardware
Ingress protection	IP66
Impact resistance	IK07
Corrosion resistance	5CE
Windage	0.116 m <sup>2</sup>

**Electrical description**

Power supply	220-240V / 50-60 Hz
Driver / Ballast	DMX
Power factor	> 0.9
Surge protection	1/2 kV (optional SP10)

**Additional information**

Lifetime	Ta=25° L90B10 > 90000h
Energy efficiency class	G (Light source)

**Fagerhult Lighting Ltd**

33-34 Dolben Street, SE1 0UQ London, United Kingdom

<https://we-ef.com/uk>

Subject to technical changes and errors. - Generated on 10/03/2025

### Optical Accessories

#### Flood lens

Description	Part ID	C1
IO-360-FLC260-LED	139-1862	332

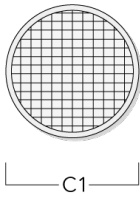

#### Honeycomb louvre

Description	Part ID	C1	H1
IW-03-FLC260-LED - [E][EE][EES]	139-1863	324	

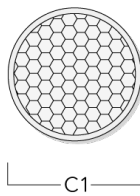

**FLC260-CC LED**

---

Description	Part ID	C1	H1
IW-FLC26_EES-CC LED	139-2434	232	209

---

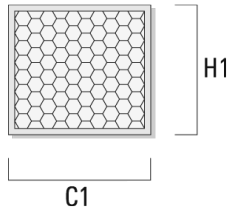

---

**Linear spread lens**

---

Description	Part ID	C1
IO-180-FLC260-CC LED	139-1861	332

---



**FLC260-CC LED**

**Wallwash lens**

---

Description	Part ID	C1
IO-20-FLC260-CC LED	139-1860	332

---



---

**Snoot**

---

Description	Part ID	A	C1
ET-FLC260-LED	139-1865	222	393

---

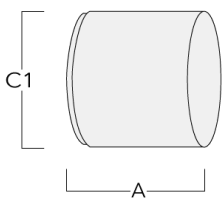

**FLC260-CC LED**

**Glare shield**

---

Description	Part ID	A	C1
ES-FLC260-LED	139-1864	222	393

---

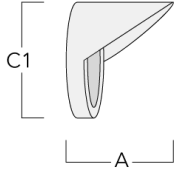

**Mounting Accessories**

**Pole clamp TS**

Description	Part ID	D1	Weight (kg)	D
TS1-2/M12 Pole clamp, single (Ø 76-89)	147-0543	76-89	1.40	76-89

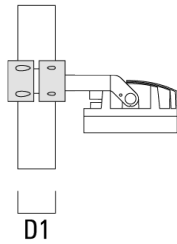
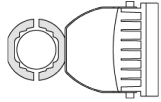

TS1-2/M12 Pole clamp, single (Ø 114-133)	147-0544	114-133	1.70	114-133
--	----------	---------	------	---------

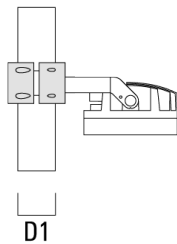
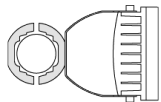

**FLC260-CC LED**

Description	Part ID	D1	Weight (kg)	D
TS2-2/M12 Pole clamp, double (Ø 76-89)	147-0545	76-89	1.40	76-89

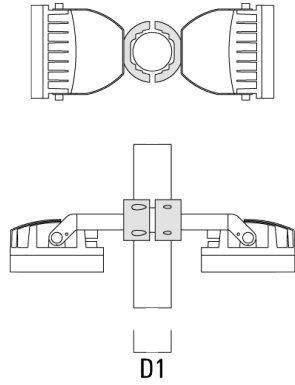

TS2-2/M12 Pole clamp, double (Ø 114-133)	147-0546	114-133	1.60	114-133
--	----------	---------	------	---------

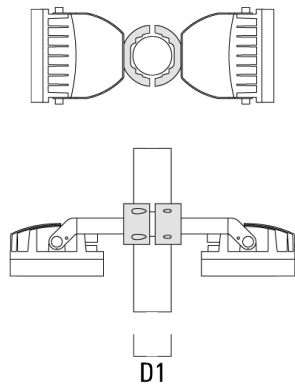



**FLC260-CC LED**

**Floodlight mounting bracket TA**

Description	Part ID	C1	D × L1	Weight (kg)	D × S
TA1 Mounting bracket, single* (Ø 76 x 200)	147-0023	130	76 x 200	1.90	76 x 200

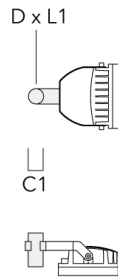

**Pole clamp PC**

Description	Part ID	D1	Weight (kg)
PC2 76-89/60 Pole clamp, double (Ø 76-89)	139-2703	76-89	1.00

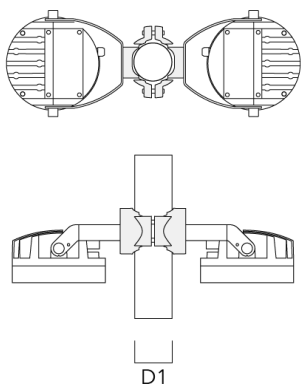

**FLC260-CC LED**

Description	Part ID	D1	Weight (kg)
PC1 76-89/60 Pole clamp, single (Ø 76-89)	139-2702	76-89	1.00

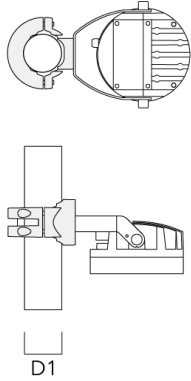

PC2 102-114/60 Pole clamp, double (Ø 102-114)	139-2707	102-114	1.20
---	----------	---------	------

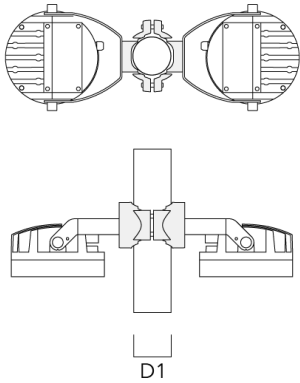

**FLC260-CC LED**

Description	Part ID	D1	Weight (kg)
PC1 102-114/60 Pole clamp, single (Ø 102-114)	139-2706	102-114	1.20

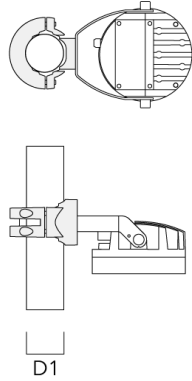

PC2 114-133/60 Pole clamp, double (Ø 114-133)	139-2709	114-133	1.40
--	----------	---------	------

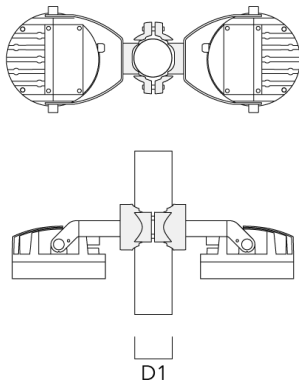

**FLC260-CC LED**

Description	Part ID	D1	Weight (kg)
PC1 114-133/60 Pole clamp, single (Ø 114-133)	139-2708	114-133	1.40



PC2 82-109/60 Pole camp, double (Ø 82-109)	139-2705	82-109	1.10
--	----------	--------	------

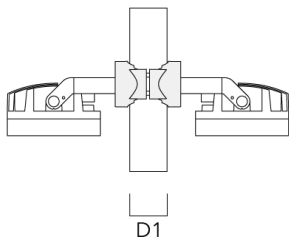

**FLC260-CC LED**

---

Description	Part ID	D1	Weight (kg)
PC1 82-109/60 Pole camp, single (Ø 82-109)	139-2704	82-109	1.10

---



D1

**FLC260-CC LED**

**Control**

**DMX Controller**

---

Description	Part ID
DMX Controller	400-0469

---

**DMX Controller (smart)**

---

Description	Part ID	Additional information
DMX Controller (smart)	400-0470	IP20. The Touch Panel is an intuitive and easy-to-use keypad or one DMX universe. It can store up to 36 scenes; alternatively, via ....

---



**FLC260-CC LED**

**DMX Controller - RDM ready**

Description	Part ID
DMX Controller - RDM ready	400-0471



**DMX Splitter**

Description	Part ID
DMX Splitter	400-0473



139-2144+139-1861

**we-ef**

**FLC260-CC LED**

### DMX Booster Box

---

Description	Part ID
DMX Booster Box	400-0474

---



---

### DMX Motion Sensor

---

Description	Part ID
DMX Motion Sensor	400-0478

---



**Fagerhult Lighting Ltd**

33-34 Dolben Street, SE1 0UQ London, United Kingdom

<https://we-ef.com/uk>

Subject to technical changes and errors. - Generated on 10/03/2025



**FLC260-CC LED**

**DMX Termination Plug**

---

Description	Part ID
DMX Termination Plug	400-0475

---



---

**DMX Plug and Socket**

---

Description	Part ID
DMX Plug and Socket	400-0479

---



**FLC260-CC LED**

**DMX Combination Cable**

---

Description	Part ID
DMX Combination Cable	400-0480

---



---

**DMX Wireless Repeater**

---

Description	Part ID
DMX Wireless Repeater	400-0477

---



**FLC260-CC LED**

**DMX Wireless Transceiver**

---

Description	Part ID
DMX Wireless Transceiver	400-0476

---



---

**DMX Controller (smart) - RDM ready**

---

Description	Part ID
DMX Controller (smart) - RDM ready	400-0472

---

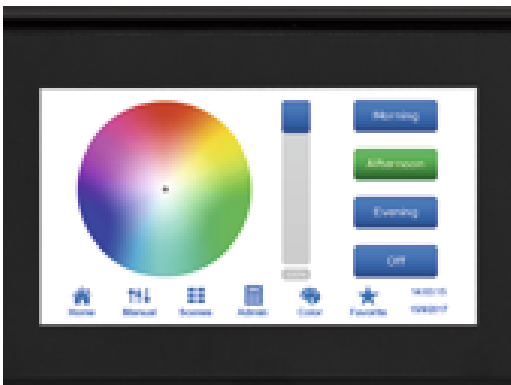

---

**DMX Wireless Antenna**

---

Description	Part ID
Antenna RF5dB	430-0036

---

**Fagerhult Lighting Ltd**

33-34 Dolben Street, SE1 0UQ London, United Kingdom

<https://we-ef.com/uk>

Subject to technical changes and errors. - Generated on 10/03/2025

**139-2144+139-1861**

**we-ef**

**FLC260-CC LED**

Description	Part ID
Antenna RF1.8dB	430-0018

**Fagerhult Lighting Ltd**

33-34 Dolben Street, SE1 0UQ London, United Kingdom

<https://we-ef.com/uk>

Subject to technical changes and errors. - Generated on 10/03/2025