



Beschreibung

RGBW/RGBA Farbwechsler. IP66, SKI. SKII auf Anfrage. IK07. Korrosionsbeständiger Aluminiumguss. PCS beschichtete Edelstahlschrauben. 5CE Korrosionsschutz. CCG® Controlled Compression Gasket Silikondichtung. Sicherheitsglas. Eine Kabelverschraubung, eine zweite Kabelverschraubung zur Durchverdrahtung auf Anfrage. Eingebaute elektronische Betriebsgeräte, thermisch getrennt. CAD-optimierte OLC® One LED Concept Technik zur Lichtlenkung und Entblendung. Eingebaute LED Platine mit WE-EF Colour Boost Technologie. Die Colour Boost Technologie ermöglicht eine gezielte Erhöhung des Lichtstroms einzelner Kanäle oder Farben über 100% hinaus. Dabei kann der maximale LED-Nennstrom pro Kanal, bei gleichzeitigem Betrieb von nur 3 oder weniger Kanälen bis auf 140% des normalen LED-Nennstroms beim Betrieb von allen 4 Kanälen gleichzeitig, im Rahmen der zur Verfügung stehenden Gesamtleistung des Scheinwerfers, erhöht werden.

DMX Schnittstelle. M20 Kabelverschraubung für Netz- und DMX-Kabel vorgesehen, WE-EF empfiehlt ein Kombikabel für DMX & Power "Power PUR-SR 3x1,5 + DMX".

Gewicht	18.00 kg
Lichtverteilung	bandförmig engstrahlend [E]
Lichtquelle	LED-36/144W - RGBA
CRI	20
Netz	EVG
LEDs	36
Bemessungsleistung	150 W

Nominal Lichtstrom (lm)

LED Lumen	275
Total Lumen	9900
Tj	85

Bemessungslichtstrom (lm)

LED Lumen	193.1
Total Lumen	6952.5
Ta	25

FLC260-CC LED

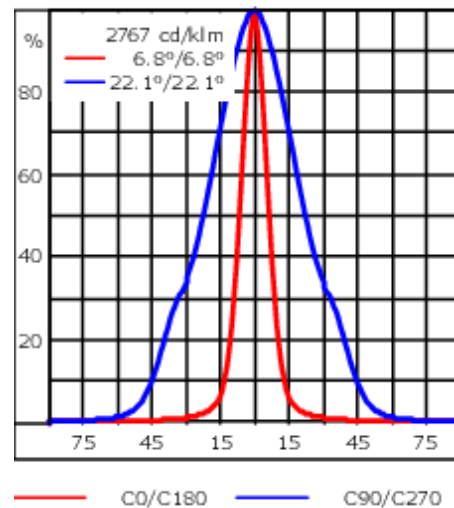
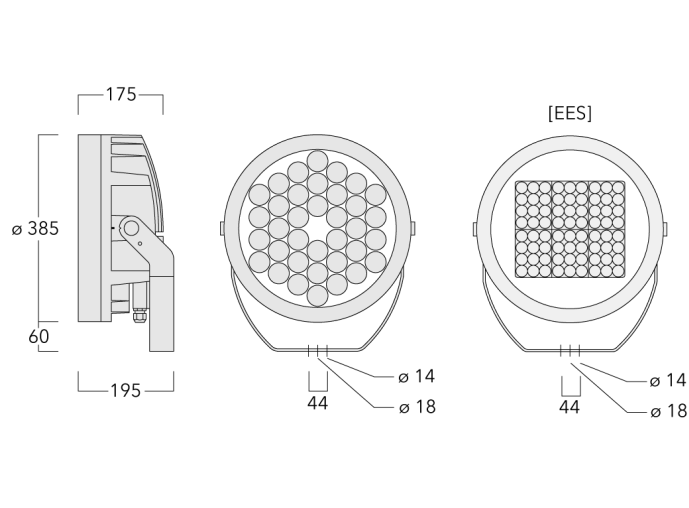

Spezifikationen

Materialbeschreibung

Gehäuse	Korrosionsbeständiger Aluminiumguss
Abdeckung	Sicherheitsglasscheibe
Farben	<div style="display: flex; flex-direction: column; gap: 5px;"> <div style="display: flex; align-items: center;"> <div style="width: 20px; height: 10px; background-color: black; margin-right: 5px;"></div> RAL9004 Signalschwarz </div> <div style="display: flex; align-items: center;"> <div style="width: 20px; height: 10px; background-color: #cccccc; margin-right: 5px;"></div> RAL9006 Weißaluminium </div> <div style="display: flex; align-items: center;"> <div style="width: 20px; height: 10px; background-color: #808080; margin-right: 5px;"></div> RAL9007 Graualuminium </div> <div style="display: flex; align-items: center;"> <div style="width: 20px; height: 10px; background-color: #333333; margin-right: 5px;"></div> RAL7016 Anthrazitgrau </div> <div style="display: flex; align-items: center;"> <div style="width: 20px; height: 10px; background-color: #e0e0e0; margin-right: 5px;"></div> RAL9016 Verkehrsweiß </div> </div>
Dichtung	CCG® Silikondichtung
Schrauben	PCS beschichtete Edelstahlschrauben
Schutzart	IP66
Schlagfestigkeit	IK07
Korrosionsbeständigkeit	5CE
Windangriffsfläche	0.116 m ²

Elektrische Beschreibung

Netz	220-240V / 50-60 Hz
Netzgerät / Vorschaltgerät	DMX
Leistungsfaktor	> 0,9
Überspannungsschutz	1/2 kV (optional SP10)

WE-EF LEUCHTEN GmbH

Töpinger Straße 16, 29646 Bispingen, Germany - Tel: +49 5194 909-0
 info.germany@we-ef.com - <https://we-ef.com/de>

Technische Änderungen und Irrtümer vorbehalten. - Erstellt am 10.03.2025

139-2144+139-1861

FLC260-CC LED

we-ef

Weitere Informationen

Lebensdauer Ta=25° L90B10 > 90000h

Energieeffizienzklasse G (Lichtquelle)

WE-EF LEUCHTEN GmbH

Töpinger Straße 16, 29646 Bispingen, Germany - Tel: +49 5194 909-0

info.germany@we-ef.com - <https://we-ef.com/de>

Technische Änderungen und Irrtümer vorbehalten. - Erstellt am 10.03.2025

139-2144+139-1861

FLC260-CC LED

we-ef

Optisches Zubehör

Streulinse allseitig

Beschreibung	Artikelnummer	C1
IO-360-FLC260-LED	139-1862	332



C1

Wabenblende

Beschreibung	Artikelnummer	C1	H1
IW-03-FLC260-LED - [E][EE][EES]	139-1863	324	

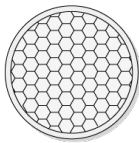

C1

WE-EF LEUCHTEN GmbH

Töpinger Straße 16, 29646 Bispingen, Germany - Tel: +49 5194 909-0

info.germany@we-ef.com - <https://we-ef.com/de>

Technische Änderungen und Irrtümer vorbehalten. - Erstellt am 10.03.2025

FLC260-CC LED

Beschreibung	Artikelnummer	C1	H1
IW-FLC26_EES-CC LED	139-2434	232	209

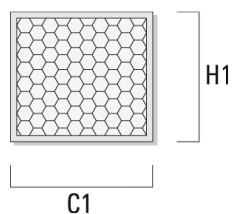

Streulinse bandförmig

Beschreibung	Artikelnummer	C1
IO-180-FLC260-CC LED	139-1861	332

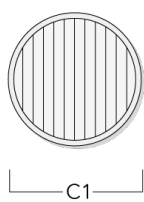

FLC260-CC LED

Wallwash Linse

Beschreibung	Artikelnummer	C1
IO-20-FLC260-CC LED	139-1860	332



Abblendtubus

Beschreibung	Artikelnummer	A	C1
ET-FLC260-LED	139-1865	222	393

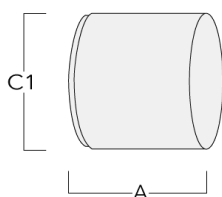

FLC260-CC LED

Seitenblende

Beschreibung	Artikelnummer	A	C1
ES-FLC260-LED	139-1864	222	393

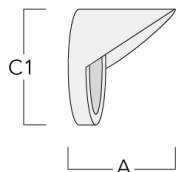

Montagezubehör

Mastschelle TS

Beschreibung	Artikelnummer	D1	Gewicht (kg)	D
TS1-2/M12 Mastschelle, einfach (Ø 76-89)	147-0543	76-89	1.40	76-89

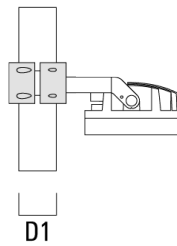
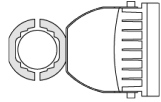

TS1-2/M12 Mastschelle, einfach (Ø 114-133)	147-0544	114-133	1.70	114-133
--	----------	---------	------	---------

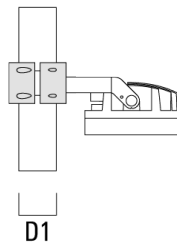
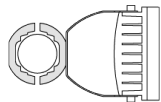

FLC260-CC LED

Beschreibung	Artikelnummer	D1	Gewicht (kg)	D
TS2-2/M12 Mastschelle, zweifach (Ø 76-89)	147-0545	76-89	1.40	76-89



TS2-2/M12 Mastschelle, zweifach (Ø 114-133)	147-0546	114-133	1.60	114-133
---	----------	---------	------	---------



FLC260-CC LED

Mastaufsatztraverse TA

Beschreibung	Artikelnummer	C1	D × L1	Gewicht (kg)	D × S
TA1 Mastaufsatztraverse, einfach* (Ø 76 x 200)	147-0023	130	76 x 200	1.90	76 x 200

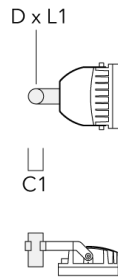

Mastschelle PC

Beschreibung	Artikelnummer	D1	Gewicht (kg)
PC2 76-89/60 Mastschelle, zweifach (Ø 76-89)	139-2703	76-89	1.00

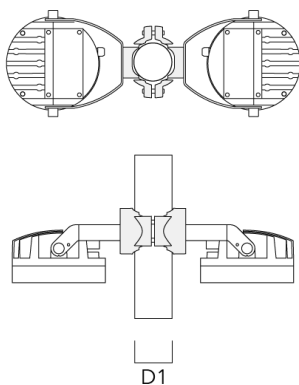

FLC260-CC LED

Beschreibung	Artikelnummer	D1	Gewicht (kg)
PC1 76-89/60 Mastschelle, einfach (Ø 76-89)	139-2702	76-89	1.00

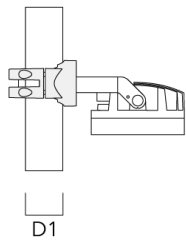
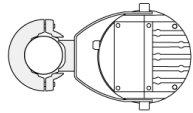

PC2 102-114/60 Mastschelle, zweifach (Ø 102-114)	139-2707	102-114	1.20
--	----------	---------	------

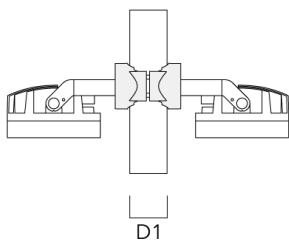
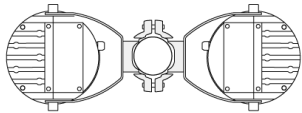

FLC260-CC LED

Beschreibung	Artikelnummer	D1	Gewicht (kg)
PC1 102-114/60 Mast­schele, einfach (Ø 102-114)	139-2706	102-114	1.20

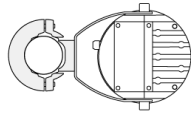

PC2 114-133/60 Mast­schele, zweifach (Ø 114-133)	139-2709	114-133	1.40
---	----------	---------	------

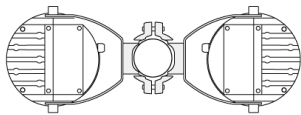

FLC260-CC LED

Beschreibung	Artikelnummer	D1	Gewicht (kg)
PC1 114-133/60 Mastschelle, einfach (Ø 114-133)	139-2708	114-133	1.40

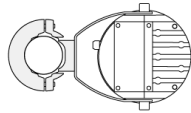

PC2 82-109/60 Mastschelle, zweifach (Ø 82-109)	139-2705	82-109	1.10
---	----------	--------	------

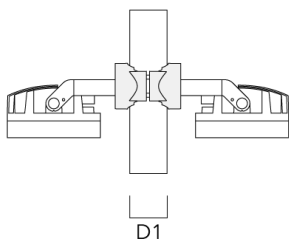

FLC260-CC LED

Beschreibung	Artikelnummer	D1	Gewicht (kg)
PC1 82-109/60 Mastschelle, einfach (Ø 82-109)	139-2704	82-109	1.10

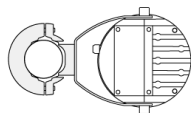

FLC260-CC LED

Steuerung

DMX Controller

Beschreibung	Artikelnummer
DMX Controller	400-0469

DMX Controller (smart)

Beschreibung	Artikelnummer	Weitere Informationen
DMX Controller (smart)	400-0470	IP20. The Touch Panel is an intuitive and easy-to-use keypad or one DMX universe. It can store up to 36 scenes; alternatively, via



FLC260-CC LED

DMX Controller - RDM ready

Beschreibung	Artikelnummer
DMX Controller - RDM ready	400-0471



DMX Splitter

Beschreibung	Artikelnummer
DMX Splitter	400-0473



139-2144+139-1861

we-ef

FLC260-CC LED

DMX Booster Box

Beschreibung	Artikelnummer
DMX Booster Box	400-0474



DMX Motion Sensor

Beschreibung	Artikelnummer
DMX Motion Sensor	400-0478



WE-EF LEUCHTEN GmbH

Töpinger Straße 16, 29646 Bispingen, Germany - Tel: +49 5194 909-0

info.germany@we-ef.com - <https://we-ef.com/de>

Technische Änderungen und Irrtümer vorbehalten. - Erstellt am 10.03.2025

FLC260-CC LED

DMX Termination Plug

Beschreibung	Artikelnummer
DMX Termination Plug	400-0475



DMX Plug and Socket

Beschreibung	Artikelnummer
DMX Plug and Socket	400-0479



DMX Combination Cable

Beschreibung	Artikelnummer
DMX Combination Cable	400-0480



DMX Wireless Repeater

Beschreibung	Artikelnummer
DMX Wireless Repeater	400-0477



FLC260-CC LED

DMX Wireless Transceiver

Beschreibung	Artikelnummer
DMX Wireless Transceiver	400-0476



DMX Controller (smart) - RDM ready

Beschreibung	Artikelnummer
DMX Controller (smart) - RDM ready	400-0472

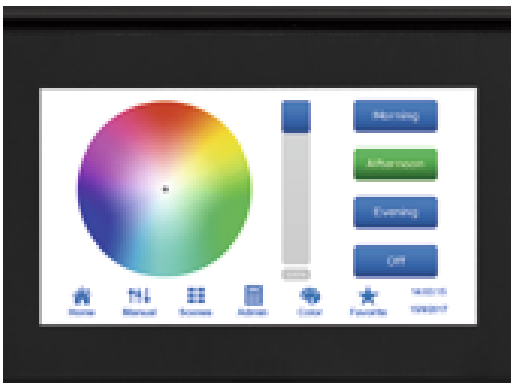

DMX Wireless Antenna

Beschreibung	Artikelnummer
Antenne RF 5dB	430-0036

WE-EF LEUCHTEN GmbH

Töpinger Straße 16, 29646 Bispingen, Germany - Tel: +49 5194 909-0
info.germany@we-ef.com - <https://we-ef.com/de>

Technische Änderungen und Irrtümer vorbehalten. - Erstellt am 10.03.2025

139-2144+139-1861

FLC260-CC LED

we-ef

Beschreibung	Artikelnummer
Antenne RF1.8 dB	430-0018

WE-EF LEUCHTEN GmbH

Töpinger Straße 16, 29646 Bispingen, Germany - Tel: +49 5194 909-0

info.germany@we-ef.com - <https://we-ef.com/de>

Technische Änderungen und Irrtümer vorbehalten. - Erstellt am 10.03.2025