



### Description

RGBW/RGBA Colour Changer. RGBW (white in 4000 K, 3000 K available on request) and RGBA. IP66. Class I. IK07. Marine-grade, die-cast aluminium alloy. 5CE superior corrosion protection including PCS hardware. Safety glass lens. Silicone CCG\_R\_ Controlled Compression Gasket. Two cable glands.

Integral EC electronic converter in thermally separated compartment. Advanced thermal management protects LEDs while optimising lumens output. CAD-optimised optics for superior illumination and glare control. OLC\_R\_ One LED Concept. LED circuit board with WE-EF Colour Boost Technology.

DMX Interface. For other control interface options to suit specific project requirements, contact WE-EF.

Weight	18.00 kg
Light distribution	linear spread, narrow beam [E]
Light source	LED-36/144W - RGBA
CRI	20
Power supply	EC
LEDs	36
Rated input power	150 W
<b>Nominal Lumen (lm)</b>	
LED Lumen	275
Total Lumen	9900
Tj	85
<b>Rated lumens (lm)</b>	
LED Lumen	193.1
Total Lumen	6952.5
Ta	25

**FLC260-CC LED**

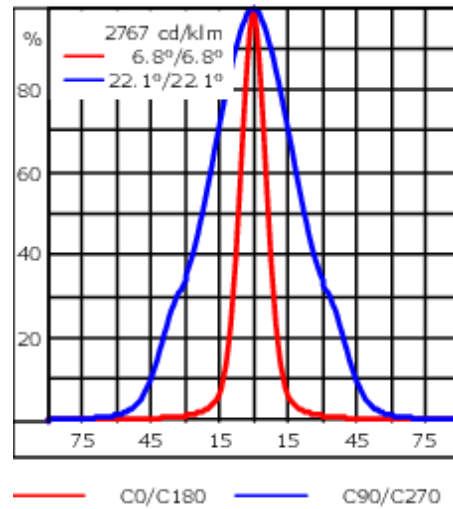
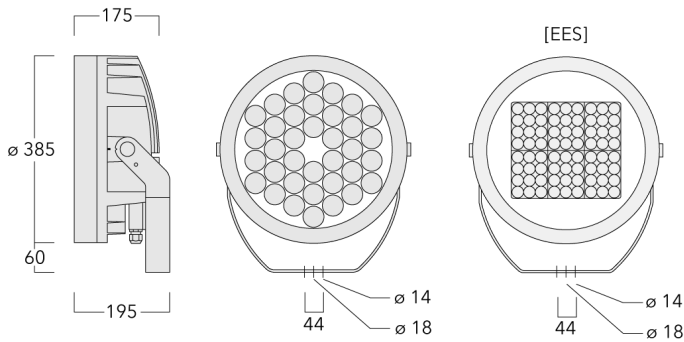

**Specifications**

**Material description**

Body	Marine-grade, die-cast aluminium alloy
Lens	Safety glass lens
Colours	<div style="display: flex; align-items: center; margin-bottom: 5px;"> <div style="width: 20px; height: 15px; background-color: black; margin-right: 5px;"></div> <span>RAL9004 Signal black</span> </div> <div style="display: flex; align-items: center; margin-bottom: 5px;"> <div style="width: 20px; height: 15px; background-color: #808080; margin-right: 5px;"></div> <span>RAL9007 Grey aluminium</span> </div> <div style="display: flex; align-items: center; margin-bottom: 5px;"> <div style="width: 20px; height: 15px; background-color: #404040; margin-right: 5px;"></div> <span>RAL7016 Anthracite grey</span> </div> <div style="display: flex; align-items: center;"> <div style="width: 20px; height: 15px; background-color: #e0e0e0; margin-right: 5px;"></div> <span>RAL9016 Traffic white</span> </div>
Gasket	Silicone CCG® Controlled Compression Gasket
Fasteners	PCS Polymer Coated Stainless Steel Hardware
Ingress protection	IP66
Impact resistance	IK07
Corrosion resistance	5CE
Windage	0.116 m <sup>2</sup>

**Electrical description**

Driver / Ballast	Integral EC electronic converter in thermally-separated compartment
Power factor	> 0.9

**Additional information**

Lifetime	Ta=25° L90B10 > 90000h
----------	------------------------

### Optical Accessories

#### Flood lens

Description	Part ID	C1
Flood lens IO-360	139-1862	332

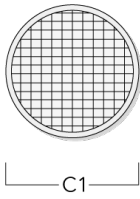

#### Honeycomb louvre

Description	Part ID	C1	H1
Honeycomb louvre IW	139-1863	324	

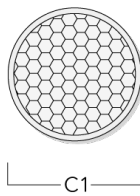

**FLC260-CC LED**

---

Description	Part ID	C1	H1
Honeycomb louvre IW for EES	139-2434	232	209

---

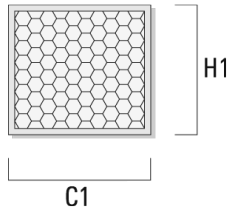

---

**Linear spread lens**

---

Description	Part ID	C1
Linear spread lens IO-180	139-1861	332

---

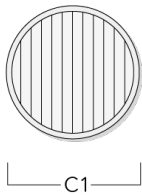

**FLC260-CC LED**

**Wallwash lens**

---

Description	Part ID	C1
Wallwash lens IO-20	139-1860-AP	332

---



---

**Snoot**

---

Description	Part ID	A	C1
Snoot ET	139-1865	222	393

---

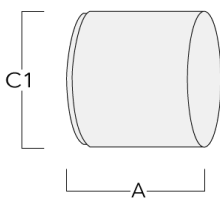

**FLC260-CC LED**

**Glare shield**

---

Description	Part ID	A	C1
Glare shield ES	139-1864	222	393

---

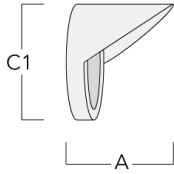

**Mounting Accessories**

**Planted root**

Description	Part ID	D1	D2	D3	D4	H1	H2	M1	T1	T2	Weight (kg)
Planted root ESV4	300-0461-AP	150	130	60	89	400	350	8	200	50 x 100	3.85

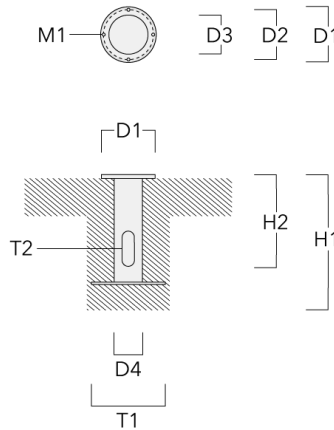

**Spigot cap**

Description	Part ID	D1	Weight (kg)
Spigot Cap KF1-M16 (ø 60 x 100)	310-9120	60 x 100	1.40

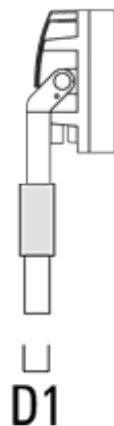

**FLC260-CC LED**

Description	Part ID	D1	Weight (kg)
Spigot Cap KF1-M16 (ø 76 x 100)	310-9121	76 x 100	2.2

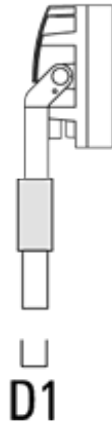

**Pole clamp SP - Tilttable**

Description	Part ID	D1	Weight (kg)	D
Pole clamp SP1-M16, single (Ø 76-89)	146-0242	76-89	1.30	76-89

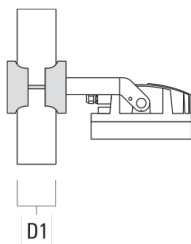



**FLC260-CC LED**

Description	Part ID	D1	Weight (kg)	D
Pole clamp SP2-M16, double (Ø 76-89)	146-0244	76-89	1.50	

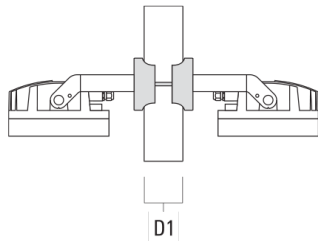

Pole clamp SP1-M16, single (Ø 38-60)	146-0241	38-60	1.30	
--------------------------------------	----------	-------	------	--

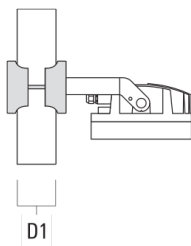

Pole clamp SP2-M16, double (Ø 38-60)	146-0243	38-60	1.50	
--------------------------------------	----------	-------	------	--

**FLC260-CC LED**

**Junction box**

Description	Part ID	Additional information	A	B	C1	Weight (kg)
Junction box JB20 - Cable side entries	310-9017	Junction boxes are made from marine-grade, die-cast aluminium alloy. IK10. IP66. For side entries and suitable to be used with cable glands.	180	143	51	1.02

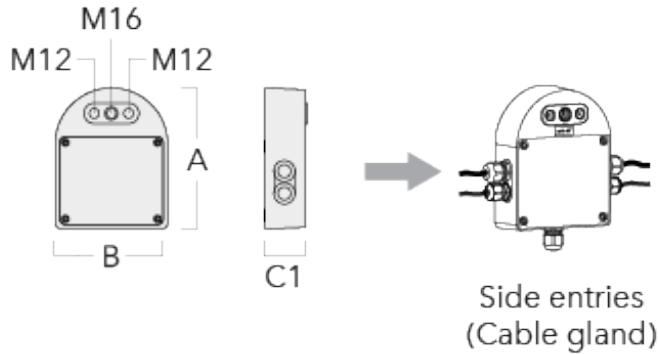

Junction box JB20 - Conduit side entries	310-9015	Junction boxes are made from marine-grade, die-cast aluminium alloy. IK10. IP66. For side entries and suitable to be used with conduits.	180	143	51	1.02
--	----------	--	-----	-----	----	------

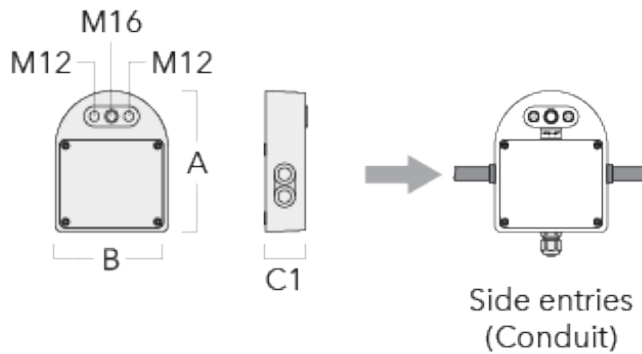

**FLC260-CC LED**

Description	Part ID	Additional information	A	B	C1	Weight (kg)
Junction box JB20 - Wall entries	310-9019	Junction boxes are made from marine-grade, die-cast aluminium alloy. IK10. IP66. For wall entries.	180	143	51	1.02

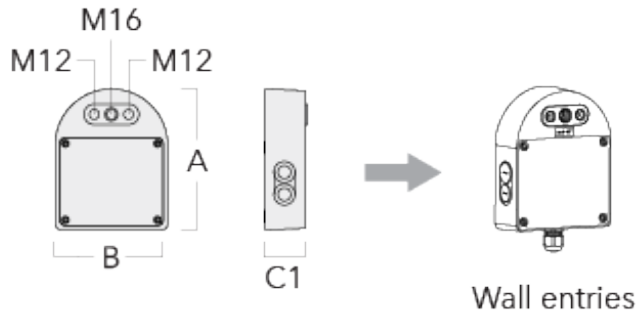

**Pole clamp PC - Rotatable**

Description	Part ID	D1	Weight (kg)
PC2 76-89/60 Pole clamp, double (Ø 76-89)	139-2703	76-89	1.00

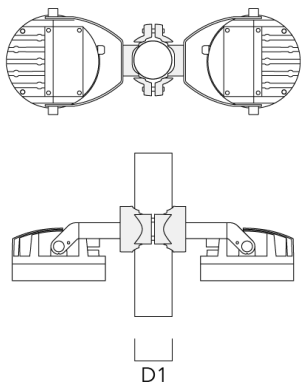

**FLC260-CC LED**

Description	Part ID	D1	Weight (kg)
PC1 76-89/60 Pole clamp, single (Ø 76-89)	139-2702	76-89	1.00

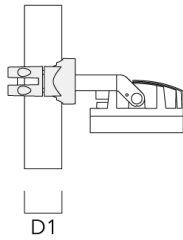
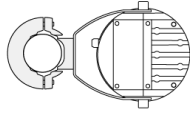

PC2 102-114/60 Pole clamp, double (Ø 102-114)	139-2707	102-114	1.20
---	----------	---------	------

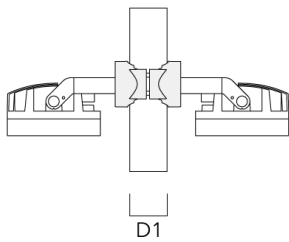

**FLC260-CC LED**

Description	Part ID	D1	Weight (kg)
PC1 102-114/60 Pole clamp, single (Ø 102-114)	139-2706	102-114	1.20

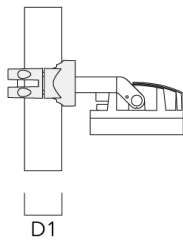
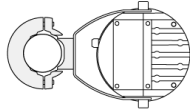

PC2 114-133/60 Pole clamp, double (Ø 114-133)	139-2709	114-133	1.40
--	----------	---------	------

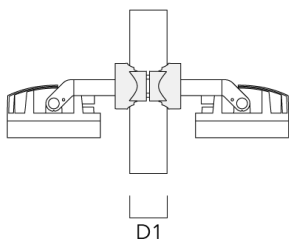
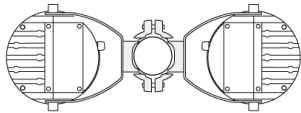

**FLC260-CC LED**

Description	Part ID	D1	Weight (kg)
PC1 114-133/60 Pole clamp, single (Ø 114-133)	139-2708	114-133	1.40

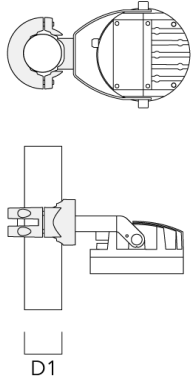

PC2 82-109/60 Pole camp, double (Ø 82-109)	139-2705	82-109	1.10
--	----------	--------	------

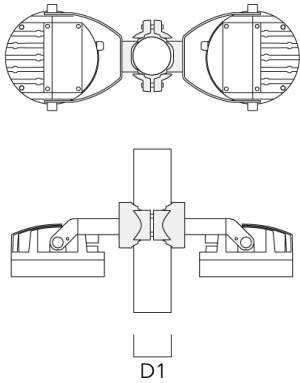

**FLC260-CC LED**

---

Description	Part ID	D1	Weight (kg)
PC1 82-109/60 Pole camp, single (Ø 82-109)	139-2704	82-109	1.10

---

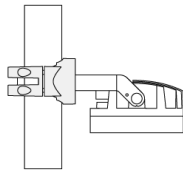
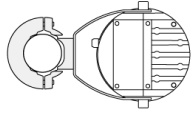

D1

**FLC260-CC LED**

**Control**

**DMX Controller**

---

Description	Part ID
DMX Controller	400-0469

---

**DMX Controller (smart)**

---

Description	Part ID	Additional information
DMX Controller (smart)	400-0470	IP20. The Touch Panel is an intuitive and easy-to-use keypad or one DMX universe. It can store up to 36 scenes; alternatively, via ....

---





**FLC260-CC LED**

**DMX Controller - RDM ready**

Description	Part ID
DMX Controller - RDM ready	400-0471



**DMX Splitter**

Description	Part ID
DMX Splitter	400-0473



139-2144+139-1861

**we-ef**

**FLC260-CC LED**

### DMX Booster Box

---

Description	Part ID
DMX Booster Box	400-0474

---



---

### DMX Motion Sensor

---

Description	Part ID
DMX Motion Sensor	400-0478

---



**WE-EF LIGHTING (Thailand) Co., Ltd.**

57 Moo 5, Kingkaew Rd., Bangplee, 10540 Samutprakarn - Phone: +66 2 738 96 20 - Fax: +66 2 738 96 29

<https://we-ef.com/asia>

Subject to technical changes and errors. - Generated on 10/03/2025

**FLC260-CC LED**

**DMX Termination Plug**

---

Description	Part ID
DMX Termination Plug	400-0475

---



---

**DMX Plug and Socket**

---

Description	Part ID
DMX Plug and Socket	400-0479

---



139-2144+139-1861

**we-ef**

**FLC260-CC LED**

### **DMX Combination Cable**

---

Description	Part ID
DMX Combination Cable	400-0480

---



---

### **DMX Wireless Repeater**

---

Description	Part ID
DMX Wireless Repeater	400-0477

---



---

**WE-EF LIGHTING (Thailand) Co., Ltd.**

57 Moo 5, Kingkaew Rd., Bangplee, 10540 Samutprakarn - Phone: +66 2 738 96 20 - Fax: +66 2 738 96 29

<https://we-ef.com/asia>

Subject to technical changes and errors. - Generated on 10/03/2025

**FLC260-CC LED**

**DMX Wireless Transceiver**

Description	Part ID
DMX Wireless Transceiver	400-0476



**DMX Controller (smart) - RDM ready**

Description	Part ID
DMX Controller (smart) - RDM ready	400-0472

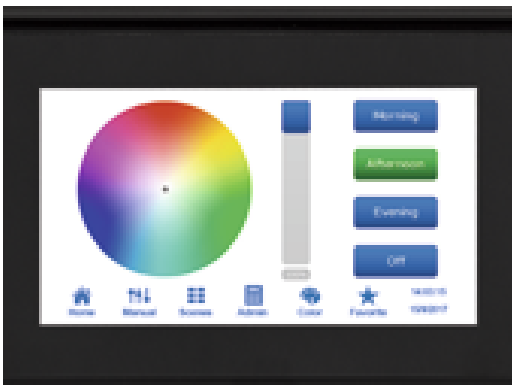

**DMX Wireless Antenna**

Description	Part ID
Antenna RF5dB	430-0036

**WE-EF LIGHTING (Thailand) Co., Ltd.**

57 Moo 5, Kingkaew Rd., Bangplee, 10540 Samutprakarn - Phone: +66 2 738 96 20 - Fax: +66 2 738 96 29

<https://we-ef.com/asia>

Subject to technical changes and errors. - Generated on 10/03/2025

**139-2144+139-1861**

**we-ef**

**FLC260-CC LED**

Description	Part ID
Antenna RF1.8dB	430-0018

**WE-EF LIGHTING (Thailand) Co., Ltd.**

57 Moo 5, Kingkaew Rd., Bangplee, 10540 Samutprakarn - Phone: +66 2 738 96 20 - Fax: +66 2 738 96 29

<https://we-ef.com/asia>

Subject to technical changes and errors. - Generated on 10/03/2025