



### Description

IP66, Class I. IK07. Marine-grade, die-cast aluminium alloy. 5CE superior corrosion protection + primer including PCS hardware. Silicone CCG® Controlled Compression Gasket. Safety glass lens. Two cable glands for improved wiring flexibility. Integral EC electronic converter, thermally separated. CAD-optimised optics for superior illumination and glare control. OLC® One LED Concept. Factory-installed LED circuit board with Tunable White Technology. DALI Interface.

Weight	7.70 kg
Light distribution	symmetric, wide beam [B]
Light source	LED-12/44W - 2200-6000 K
CRI	80
Power supply	EC
LEDs	12
Rated input power	51 W
<b>Nominal Lumen (lm)</b>	
LED Lumen	420
Total Lumen	5040
Tj	85
<b>Rated lumens (lm)</b>	
LED Lumen	318
Total Lumen	3815.8
Ta	25



## Specifications

### Material description

Body	Marine-grade, die-cast aluminium alloy
Lens	Safety glass lens
Colours	<div style="display: flex; align-items: center;"> <div style="width: 20px; height: 15px; background-color: black; margin-right: 5px;"></div> <div style="margin-right: 10px;">RAL9004 Signal black</div> </div> <div style="display: flex; align-items: center;"> <div style="width: 20px; height: 15px; background-color: #cccccc; margin-right: 5px;"></div> <div style="margin-right: 10px;">RAL9006 White aluminium</div> </div> <div style="display: flex; align-items: center;"> <div style="width: 20px; height: 15px; background-color: #808080; margin-right: 5px;"></div> <div style="margin-right: 10px;">RAL9007 Grey aluminium</div> </div>
Gasket	Silicone CCG® Controlled Compression Gasket
Fasteners	PCS Polymer Coated Stainless Steel Hardware (unpainted)
Ingress protection	IP66
Impact resistance	IK07
Corrosion resistance	5CE+Primer
Windage	0.054 m <sup>2</sup>

### Electrical description

Power supply	230V / 50 Hz
Driver / Ballast	DALI

### Additional information

Lifetime	Ta=40° L90B10 > 90000h
Warranty	The product is supplied with 10-year warranty. Please refer to the LED Warranty Statement located on <a href="http://www.we-ef.com">www.we-ef.com</a> for further details.

**Mounting Accessories**

**Floodlight mounting bracket TA**

Description	Part ID	A	C1	D x L1	Weight (kg)	D x S
TA2-L Mounting bracket, double (Ø 76 x 200)	147-0105	±90°	420	76 x 200	16.10	76 x 200

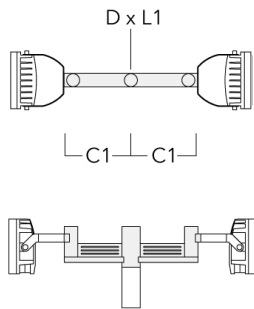

TA2 Mounting bracket, double* (Ø 76 x 200)	147-0024		130	76 x 200	1.90	76 x 200
--	----------	--	-----	----------	------	----------

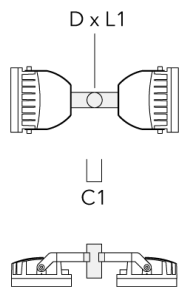

**FLC230-TW LED**

**Planted root**

Description	Part ID	D1	D2	D3	D4	H1	H2	M1	T1	T2	Weight (kg)
Planted root ESV4	300-0461-AP	150	130	60	89	400	350	8	200	50 x 100	3.85

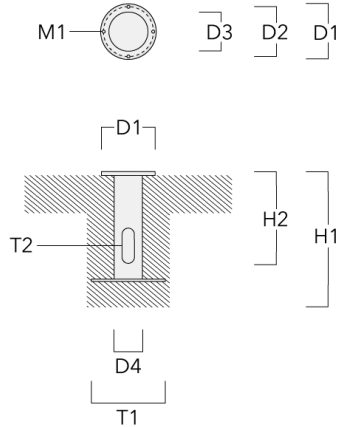

**Spigot cap KF**

Description	Part ID	D1	Weight (kg)	D
KF1-60/M16	310-9120	60x100	2.00	60 x 100

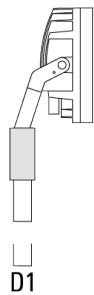

**FLC230-TW LED**

Description	Part ID	D1	Weight (kg)	D
KF1-76/M16	310-9121	76 x 100	2.00	76 x 100

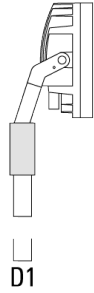

**Pole clamp PC - Rotatable**

Description	Part ID	D1	Weight (kg)
PC2 76-89/60 Pole clamp, double (Ø 76-89)	139-2703	76-89	1.00

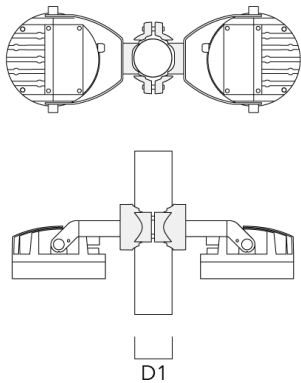

**FLC230-TW LED**

Description	Part ID	D1	Weight (kg)
PC1 76-89/60 Pole clamp, single (Ø 76-89)	139-2702	76-89	1.00

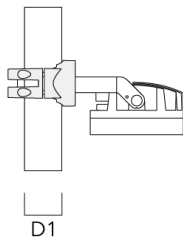
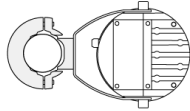

PC2 102-114/60 Pole clamp, double (Ø 102-114)	139-2707	102-114	1.20
---	----------	---------	------

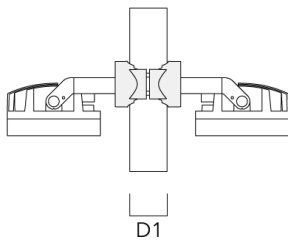

**FLC230-TW LED**

Description	Part ID	D1	Weight (kg)
PC1 102-114/60 Pole clamp, single (Ø 102-114)	139-2706	102-114	1.20



PC2 114-133/60 Pole clamp, double (Ø 114-133)	139-2709	114-133	1.40
--	----------	---------	------



**FLC230-TW LED**

Description	Part ID	D1	Weight (kg)
PC1 114-133/60 Pole clamp, single (Ø 114-133)	139-2708	114-133	1.40

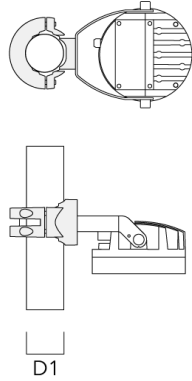

PC2 82-109/60 Pole camp, double (Ø 82-109)	139-2705	82-109	1.10
--	----------	--------	------

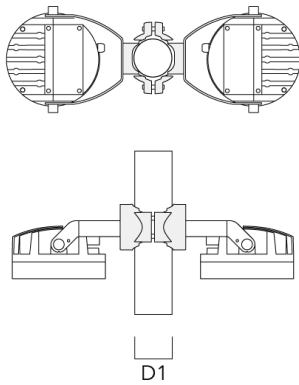



**FLC230-TW LED**

---

Description	Part ID	D1	Weight (kg)
PC1 82-109/60 Pole camp, single (Ø 82-109)	139-2704	82-109	1.10

---

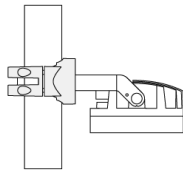

D1

### Optical Accessories

#### Linear spread lens

---

Description	Part ID	C1
IO-180-FLC230-LED	139-1849	199

---

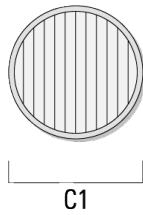

---

#### Surface wash lens

---

Description	Part ID	C1
IO-360-FLC230-LED	139-1850	199

---

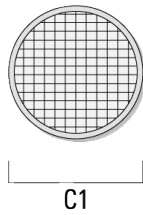

**Glare shield**

Description	Part ID	A	C1
ES-FLC230-LED	139-1852	159	266

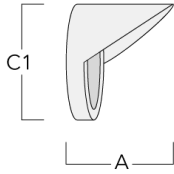

**Snoot**

Description	Part ID	A	C1
ET-FLC230-LED	139-1853	160	266

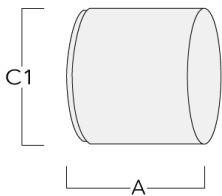

**139-2044**

**FLC230-TW LED**

**we-ef**

**Wallwash lens**

---

Description	Part ID	C1
Wallwash lens IO-20°	139-1848	199

---

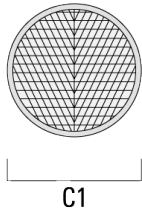

---

**WE-EF LIGHTING Pty Ltd**

6/13 Downard Street, 3195 Braeside, Victoria - Phone: +61 3 8587 0444 - Fax: +61 3 8587 0499

info.australia@we-ef.com - <https://we-ef.com/aus>

Subject to technical changes and errors. - Generated on 23/11/2024

**139-2044**

**FLC230-TW LED**

**we-ef**

## **Control**

### **R2C Ready to Connect**

Description	Part ID
R2C Ready to Connect (top)	430-0019

**WE-EF LIGHTING Pty Ltd**

6/13 Downard Street, 3195 Braeside, Victoria - Phone: +61 3 8587 0444 - Fax: +61 3 8587 0499

info.australia@we-ef.com - <https://we-ef.com/aus>

Subject to technical changes and errors. - Generated on 23/11/2024