

139-2135

FLC230-TW LED

**we-ef**



### Description

IP66. Classe I. Classe II sur demande. IK07. Corps en fonte d'aluminium. Visserie inox avec traitement PCS. Protection contre la corrosion 5CE. Joint silicone. Verre de sécurité. DALI interface.

Poids	7.70 kg
Distribution de la lumière	faisceau symétrique, intensif [E]
Source lumineuse	LED-12/44W - 2200-6000 K
IRC	80
Alimentation électrique	ballast électronique
LEDs	12
Rated input power	51 W

### Flux lumineux nominal (lm)

LED Lumen	420
Total Lumen	5040
Tj	85

### Rated lumens (lm)

LED Lumen	344.1
Total Lumen	4128.9
Ta	25

### WE-EF Switzerland AG

Himmelrichstrasse 6, 6003 Luzern - Téléphone: +41 22 752 49 94

info.switzerland@we-ef.com - [https://we-ef.com/ch\\_fr](https://we-ef.com/ch_fr)

Sous réserve de modifications techniques et d'erreurs. - Généré le 23/11/2024

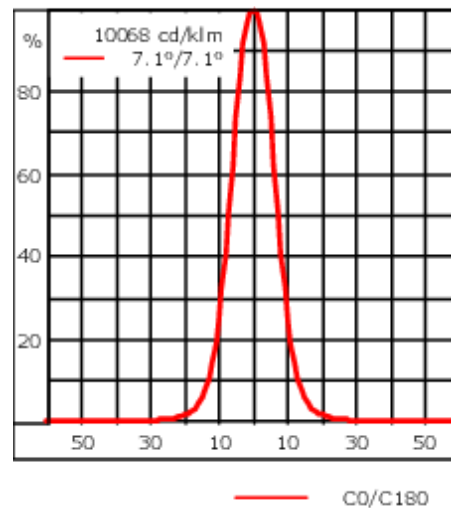
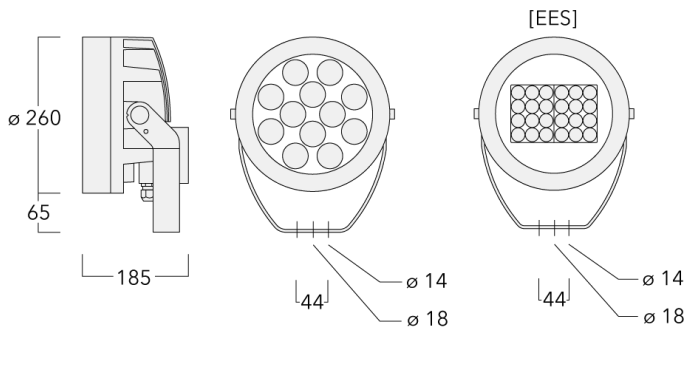

## Spécifications

### Description du matériel

Corps	Corps en fonte d'aluminium, visserie inox avec traitement PCS
Lentille	Safety glass lens
Couleurs	<div style="display: flex; flex-direction: column; gap: 5px;"> <div><span style="display: inline-block; width: 20px; height: 10px; background-color: black; margin-right: 5px;"></span> RAL9004 Noir de sécurité</div> <div><span style="display: inline-block; width: 20px; height: 10px; background-color: gray; margin-right: 5px;"></span> RAL9007 Aluminium gris</div> <div><span style="display: inline-block; width: 20px; height: 10px; background-color: darkgray; margin-right: 5px;"></span> RAL7016 Gris anthracite</div> <div><span style="display: inline-block; width: 20px; height: 10px; background-color: lightgray; margin-right: 5px;"></span> RAL9016 Blanc signalisation</div> </div>
Joint	Joint silicone CCG®
Visserie	PCS Inox avec recouvrement polymère
IP	IP66
IK	IK07
Protection contre la corrosion	5CE
Surface exposée au vent	0.054 m <sup>2</sup>

### Description électrique

Driver	DALI
--------	------

### Informations complémentaires

Durée de vie	Ta=25° L90B10 > 90000h
Classe d'efficacité énergétique	E

#### WE-EF Switzerland AG

Himmelrichstrasse 6, 6003 Luzern - Téléphone: +41 22 752 49 94

info.switzerland@we-ef.com - [https://we-ef.com/ch\\_fr](https://we-ef.com/ch_fr)

Sous réserve de modifications techniques et d'erreurs. - Généré le 23/11/2024

## Accessoires d'installation

## Traverse pour mâts

Description	Référence	A	C1	D x L1	Poids (kg)	D x S
TA2-L traverse longue orientable (Ø 76 x 200)	147-0105	±90°	420	76 x 200	16.10	76 x 200

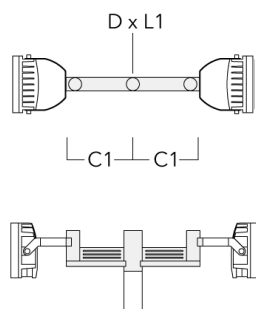

TA2 traverse double (Ø 76 x 200)	147-0024		130	76 x 200	1.90	76 x 200
----------------------------------	----------	--	-----	----------	------	----------

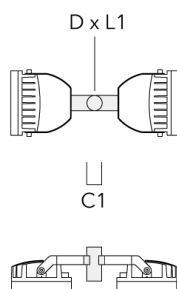

## Collier pour mâts PC

Description	Référence	D1	Poids (kg)
PC2 76-89/60 collier double pour tube (Ø 76-89)	139-2703	76-89	1.00

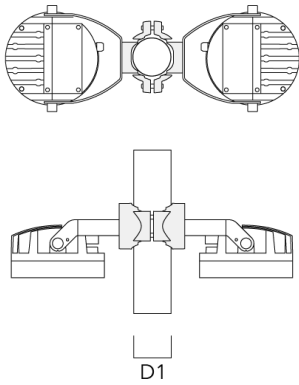

PC1 76-89/60 collier simple (Ø 76-89)	139-2702	76-89	1.00
---------------------------------------	----------	-------	------

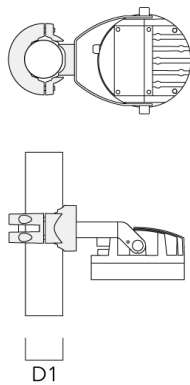

## FLC230-TW LED

Description	Référence	D1	Poids (kg)
PC2 102-114/60 collier double pour tube (Ø 102-114)	139-2707	102-114	1.20

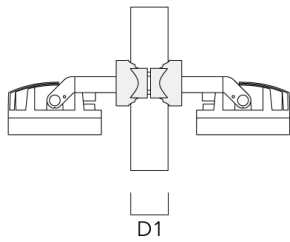
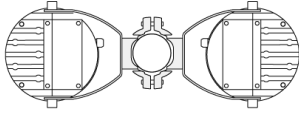

PC1 102-114/60 collier simple (Ø 102-114)	139-2706	102-114	1.20
---	----------	---------	------

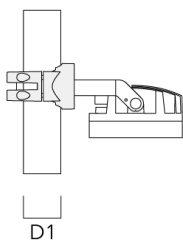
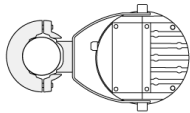

## FLC230-TW LED

Description	Référence	D1	Poids (kg)
PC2 114-133/60 collier double pour tube (Ø 114-133)	139-2709	114-133	1.40



PC1 114-133/60 collier simple (Ø 114-133)	139-2708	114-133	1.40
---	----------	---------	------

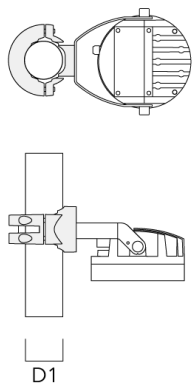

## FLC230-TW LED

---

Description	Référence	D1	Poids (kg)
PC2 82-109/60 collier double pour tube (Ø 82-109)	139-2705	82-109	1.10

---

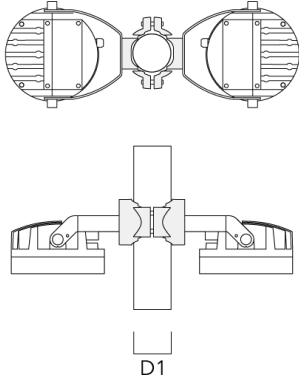

---

PC1 82-109/60 collier simple (Ø 82-109)	139-2704	82-109	1.10
---	----------	--------	------

---

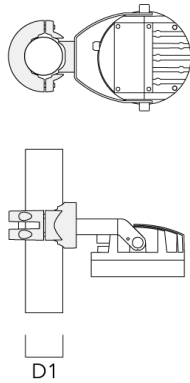

**Accessoires Optiques****Lentille ovalisante**

Description	Référence	C1
IO-180-FLC230-LED	139-1849	199

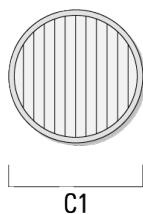
**Lentille e'largissante**

Description	Référence	C1
IO-360-FLC230-LED	139-1850	199

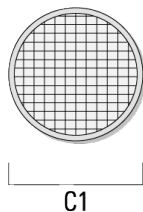



**Visière**

Description	Référence	A	C1
Visière ES	139-1852	159	266

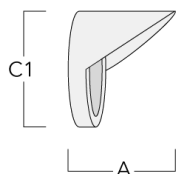
**Canon anti-éblouissement**

Description	Référence	A	C1
Canon anti-éblouissement ET	139-1853	160	266

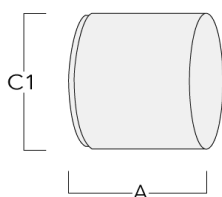

**Lentille rasante**

Description	Référence	C1
IO-20-FLC230-LED	139-1848	199

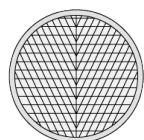

C1

**Control****DMX Wireless Repeater**

---

Description	Référence
DMX Wireless Repeater	400-0477

---

**DMX Wireless Transceiver**

---

Description	Référence
DMX Wireless Transceiver	400-0476

---

**WE-EF Switzerland AG**

Himmelrichstrasse 6, 6003 Luzern - Téléphone: +41 22 752 49 94

info.switzerland@we-ef.com - [https://we-ef.com/ch\\_fr](https://we-ef.com/ch_fr)

Sous réserve de modifications techniques et d'erreurs. - Généré le 23/11/2024

**139-2135**

**FLC230-TW LED**

**we-ef**

**R2C Ready to Connect**

Description	Référence
R2C Ready to Connect (top)	430-0019

**WE-EF Switzerland AG**

Himmelrichstrasse 6, 6003 Luzern - Téléphone: +41 22 752 49 94

info.switzerland@we-ef.com - [https://we-ef.com/ch\\_fr](https://we-ef.com/ch_fr)

Sous réserve de modifications techniques et d'erreurs. - Généré le 23/11/2024