



Description

IP66. Classe I. Classe II sur demande. IK07. Corps en fonte d'aluminium. Visserie inox avec traitement PCS. Protection contre la corrosion 5CE. Joint silicone. Verre de sécurité. LED Tunable White Technology. Interface DALI.

| | |
|----------------------------|-----------------------------------|
| Poids | 13.80 kg |
| Distribution de la lumière | faisceau symétrique, extensif [B] |
| Source lumineuse | LED-24/88W - 2200-6000 K |
| IRC | 80 |
| Alimentation électrique | ballast électronique |
| LEDs | 24 |
| Rated input power | 102 W |

Flux lumineux nominal (lm)

| | |
|-------------|-------|
| LED Lumen | 420 |
| Total Lumen | 10080 |
| Tj | 85 |

Rated lumens (lm)

| | |
|-------------|--------|
| LED Lumen | 318 |
| Total Lumen | 7631.5 |
| Ta | 25 |

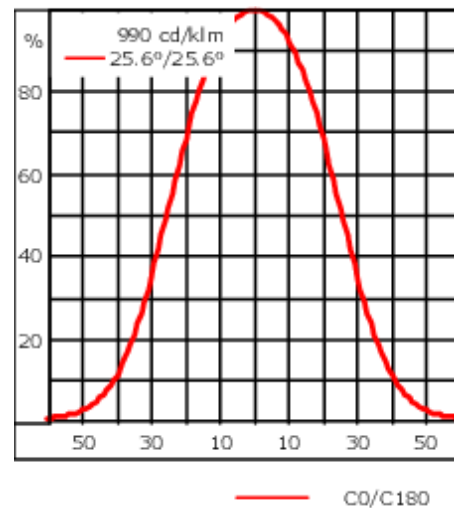
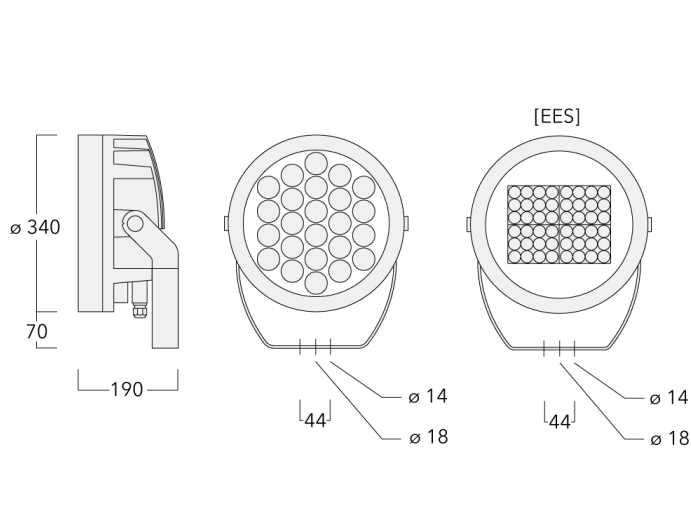

Spécifications

Description du matériel

| | |
|--------------------------------|----------------------------------------------------------------------------------------------------------------------------------------------------------------------------------------------------------------------------------------------------------------------------------------------------------------------------------------------------------------------------------------------------------------------------------------------------------------------------------------------------------------------------------------------------------------------------------------------------------------------------------------------------------------------------------------------------------------------------------------------------------------------------------------------------------------------------------|
| Corps | Corps en fonte d'aluminium, visserie inox avec traitement PCS |
| Lentille | Verre de sécurité |
| Couleurs | <div style="display: flex; align-items: center;"> <div style="width: 20px; height: 15px; background-color: black; margin-right: 5px;"></div> RAL9004 Noir de sécurité </div> <div style="display: flex; align-items: center; margin-top: 5px;"> <div style="width: 20px; height: 15px; background-color: gray; margin-right: 5px;"></div> RAL9007 Aluminium gris </div> <div style="display: flex; align-items: center; margin-top: 5px;"> <div style="width: 20px; height: 15px; background-color: darkgray; margin-right: 5px;"></div> RAL7016 Gris anthracite </div> <div style="display: flex; align-items: center; margin-top: 5px;"> <div style="width: 20px; height: 15px; background-color: lightgray; margin-right: 5px;"></div> RAL9016 Blanc signalisation </div> |
| Joint | Joint silicone CCG® |
| Visserie | PCS Inox avec recouvrement polymère |
| IP | IP66 |
| IK | IK07 |
| Protection contre la corrosion | 5CE |
| Surface exposée au vent | 0.090 m ² |

Description électrique

| | |
|--------|------|
| Driver | DALI |
|--------|------|

Informations complémentaires

| | |
|--------------|------------------------|
| Durée de vie | Ta=25° L90B10 > 90000h |
|--------------|------------------------|

WE-EF Switzerland AG

Himmelrichstrasse 6, 6003 Luzern - Téléphone: +41 22 752 49 94

info.switzerland@we-ef.com - https://we-ef.com/ch_fr

Sous réserve de modifications techniques et d'erreurs. - Généré le 23/11/2024

Accessoires d'installation

Collier pour mâts TS

| Description | Référence | D1 | Poids (kg) | D |
|-------------------------------------------------|-----------|-------|------------|-------|
| TS1-2/M12 collier simple pour tube (Ø 76-89) | 147-0543 | 76-89 | 1.40 | 76-89 |

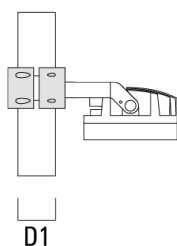
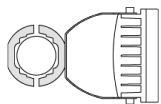

| | | | | |
|---------------------------------------------------|----------|---------|------|---------|
| TS1-2/M12 collier simple pour tube (Ø 102-114) | 147-0526 | 102-114 | 1.50 | 102-114 |
|---------------------------------------------------|----------|---------|------|---------|

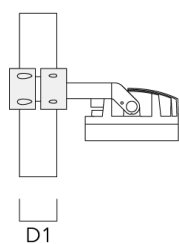
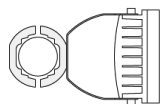

FLC240-TW LED

| Description | Référence | D1 | Poids (kg) | D |
|---------------------------------------------------|-----------|---------|------------|---------|
| TS1-2/M12 collier simple pour tube (Ø 114-133) | 147-0544 | 114-133 | 1.70 | 114-133 |

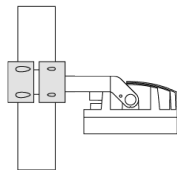
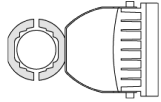

D1

| | | | | |
|-------------------------------------------------|----------|-------|------|-------|
| TS2-2/M12 collier double pour tube (Ø 76-89) | 147-0545 | 76-89 | 1.40 | 76-89 |
|-------------------------------------------------|----------|-------|------|-------|

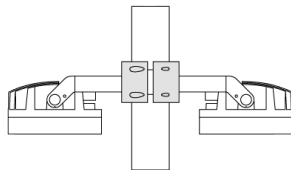
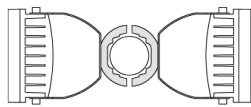

D1

FLC240-TW LED

| Description | Référence | D1 | Poids (kg) | D |
|---------------------------------------------------|-----------|---------|------------|---------|
| TS2-2/M12 collier double pour tube (Ø 102-114) | 147-0527 | 102-114 | 1.50 | 102-114 |

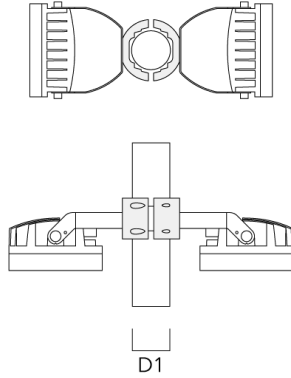

| | | | | |
|---------------------------------------------------|----------|---------|------|---------|
| TS2-2/M12 collier double pour tube (Ø 114-133) | 147-0546 | 114-133 | 1.60 | 114-133 |
|---------------------------------------------------|----------|---------|------|---------|

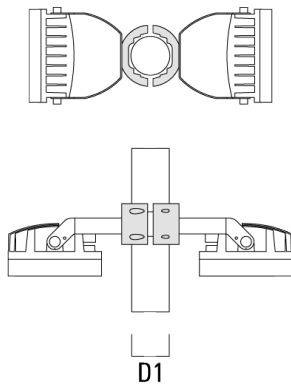

Traverse pour mâts

| Description | Référence | A | C1 | D x L1 | Poids (kg) | D x S |
|-----------------------------------------------|-----------|------|-----|----------|------------|----------|
| TA2-L traverse longue orientable (Ø 76 x 200) | 147-0105 | ±90° | 420 | 76 x 200 | 16.10 | 76 x 200 |

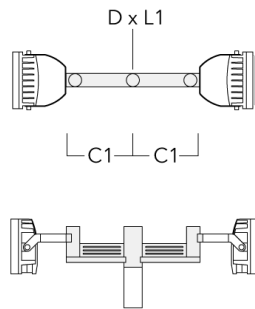

| | | | | | | |
|---------------------------------------------|----------|------|-----|----------|-------|----------|
| TA3 traverse triple orientable (Ø 89 x 200) | 147-0025 | ±90° | 650 | 89 x 200 | 17.90 | 89 x 200 |
|---------------------------------------------|----------|------|-----|----------|-------|----------|

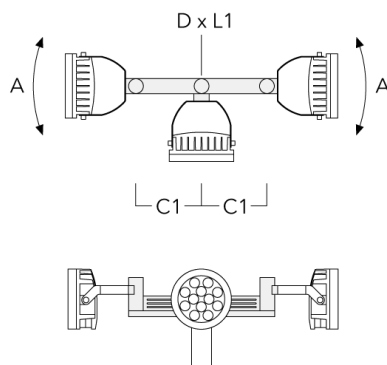

FLC240-TW LED

| Description | Référence | A | C1 | D x L1 | Poids (kg) | D x S |
|----------------------------------------------|-----------|------|-----|----------|------------|----------|
| TA4 Traverse pour 4 projecteurs (Ø 89 x 200) | 147-0099 | ±90° | 650 | 89 x 200 | 20.80 | 89 x 200 |



| | | | | | | |
|-----------------------------------|----------|--|-----|-----------|------|-----------|
| TA1 traverse simple (Ø 108 x 200) | 147-0096 | | 130 | 108 x 200 | 7.50 | 108 x 200 |
|-----------------------------------|----------|--|-----|-----------|------|-----------|

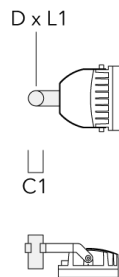

FLC240-TW LED

| Description | Référence | A | C1 | D × L1 | Poids (kg) | D × S |
|-----------------------------------|-----------|---|-----|-----------|------------|-----------|
| TA2 traverse double (Ø 108 x 200) | 147-0097 | | 130 | 108 x 200 | 7.50 | 108 x 200 |

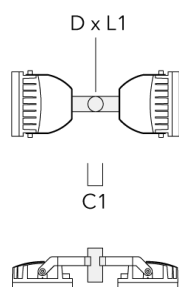

| | | | | | | |
|------------------------------------------------|----------|------|-----|-----------|-------|-----------|
| TA2-L traverse longue orientable (Ø 108 x 200) | 147-0148 | ±90° | 420 | 108 x 200 | 20.20 | 108 x 200 |
|------------------------------------------------|----------|------|-----|-----------|-------|-----------|

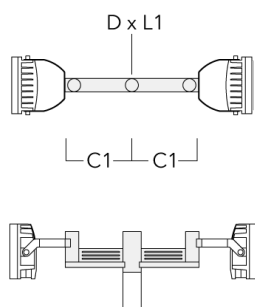

FLC240-TW LED

| Description | Référence | A | C1 | D x L1 | Poids (kg) | D x S |
|----------------------------------------------|-----------|------|-----|-----------|------------|-----------|
| TA3 traverse triple orientable (Ø 108 x 200) | 147-0098 | ±90° | 650 | 108 x 200 | 24.20 | 108 x 200 |

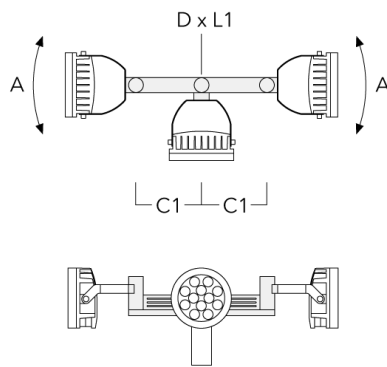

| | | | | | | |
|-----------------------------------------------|----------|------|-----|-----------|-------|-----------|
| TA4 Traverse pour 4 projecteurs (Ø 108 x 200) | 147-0100 | ±90° | 650 | 108 x 200 | 24.20 | 108 x 200 |
|-----------------------------------------------|----------|------|-----|-----------|-------|-----------|

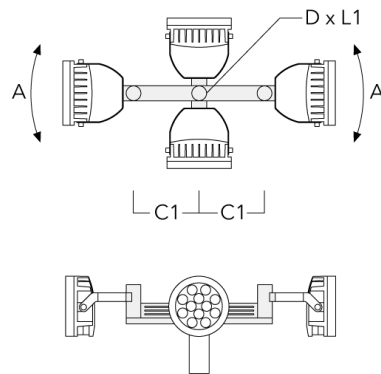
**WE-EF Switzerland AG**

Himmelrichstrasse 6, 6003 Luzern - Téléphone: +41 22 752 49 94

info.switzerland@we-ef.com - https://we-ef.com/ch_fr

Sous réserve de modifications techniques et d'erreurs. - Généré le 23/11/2024

FLC240-TW LED

Collier pour mâts PC

| Description | Référence | D1 | Poids (kg) |
|-------------------------------------------------|-----------|-------|------------|
| PC2 76-89/60 collier double pour tube (Ø 76-89) | 139-2703 | 76-89 | 1.00 |

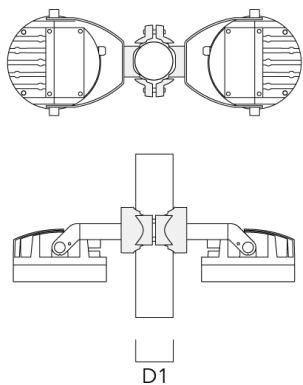

| | | | |
|---------------------------------------|----------|-------|------|
| PC1 76-89/60 collier simple (Ø 76-89) | 139-2702 | 76-89 | 1.00 |
|---------------------------------------|----------|-------|------|

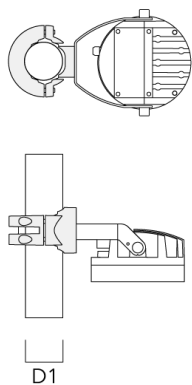

FLC240-TW LED

| Description | Référence | D1 | Poids (kg) |
|-----------------------------------------------------|-----------|---------|------------|
| PC2 102-114/60 collier double pour tube (Ø 102-114) | 139-2707 | 102-114 | 1.20 |

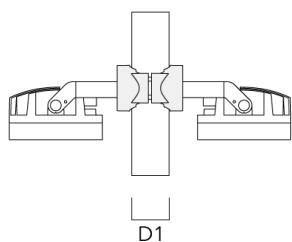
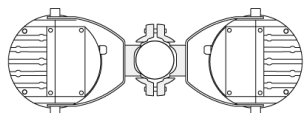

| | | | |
|-------------------------------------------|----------|---------|------|
| PC1 102-114/60 collier simple (Ø 102-114) | 139-2706 | 102-114 | 1.20 |
|-------------------------------------------|----------|---------|------|

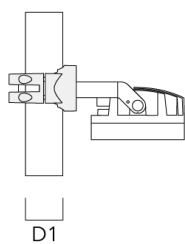
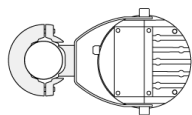

FLC240-TW LED

| Description | Référence | D1 | Poids (kg) |
|-----------------------------------------------------|-----------|---------|------------|
| PC2 114-133/60 collier double pour tube (Ø 114-133) | 139-2709 | 114-133 | 1.40 |

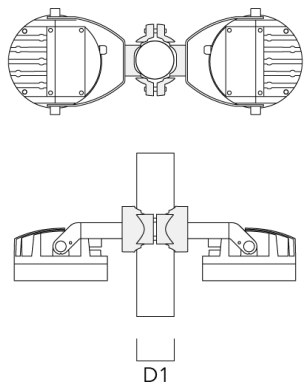

| | | | |
|-------------------------------------------|----------|---------|------|
| PC1 114-133/60 collier simple (Ø 114-133) | 139-2708 | 114-133 | 1.40 |
|-------------------------------------------|----------|---------|------|

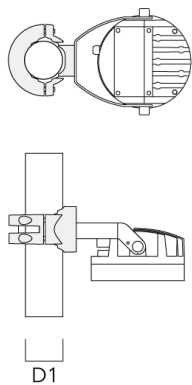

FLC240-TW LED

| Description | Référence | D1 | Poids (kg) |
|---------------------------------------------------|-----------|--------|------------|
| PC2 82-109/60 collier double pour tube (Ø 82-109) | 139-2705 | 82-109 | 1.10 |

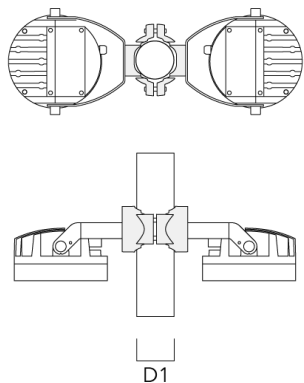

Accessoires Optiques

Canon anti-éblouissement

| Description | Référence | A | C1 |
|---------------|-----------|-----|-----|
| ET-FLC240-LED | 139-1859 | 200 | 346 |

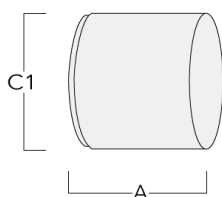

Visière

| Description | Référence | A | C1 |
|---------------|-----------|-----|-----|
| ES-FLC240-LED | 139-1858 | 200 | 346 |

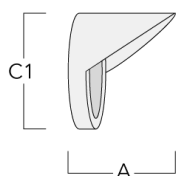

Control**DMX Wireless Repeater**

| Description | Référence |
|-----------------------|-----------|
| DMX Wireless Repeater | 400-0477 |



DMX Wireless Transceiver

| Description | Référence |
|--------------------------|-----------|
| DMX Wireless Transceiver | 400-0476 |

**WE-EF Switzerland AG**

Himmelrichstrasse 6, 6003 Luzern - Téléphone: +41 22 752 49 94

info.switzerland@we-ef.com - https://we-ef.com/ch_fr

Sous réserve de modifications techniques et d'erreurs. - Généré le 23/11/2024

R2C Ready to Connect

| Description | Référence |
|----------------------------|-----------|
| R2C Ready to Connect (top) | 430-0019 |