

## FLC240 LED TUNABLE WHITE

**Description**

Tunable White.

IP66. Class I. IK07. Marine-grade, die-cast aluminum alloy. 5CE superior corrosion protection including PCS hardware. Silicone CCG® Controlled Compression Gasket. Safety glass lens. One cable gland, second gland for through wiring on request. CAD-optimized optics for superior illumination and glare control. Integral driver, thermally separated. OLC® One LED Concept. Factory-installed LED circuit board. DMX interface.

Specify product with 7 Digit product code - Finish Color. Accessories, such as mounting, optical, and electrical, must be specified separately.

Example: XXX-XXXX-9004 (Black)  
+ XXX-XXXX (Accessory 1)

Weight	30.42 lb
Light distribution	symmetric, narrow beam [N]
Light source	LED-24/88W - 2200-6000 K
CRI	80
Power supply	electronic gear
LEDs	24
Rated input power	102 W

**Nominal Lumen (lm)**

LED Lumen	420
Total Lumen	10080
Tj	85

**Delivered lumens (lm)**

LED Lumen	344.1
Total Lumen	8257.8
Ta	25

**FLC240 LED TUNABLE WHITE**

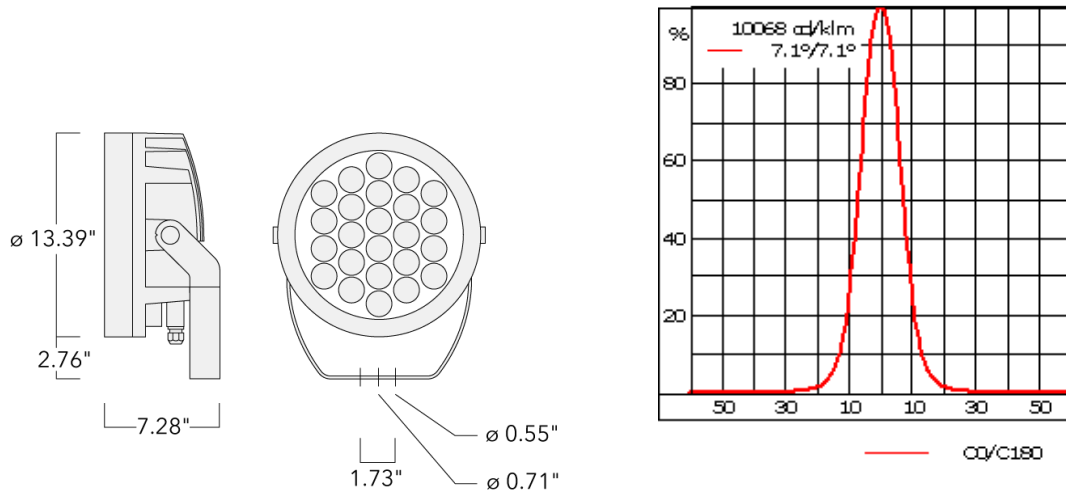

**Specifications**

**Material description**

Body	Marine-grade, die-cast aluminium alloy
Lens	Safety glass lens
Colors	<div style="display: flex; flex-direction: column; gap: 5px;"> <div><span style="display: inline-block; width: 15px; height: 15px; background-color: black; margin-right: 5px;"></span> RAL9004 Black</div> <div><span style="display: inline-block; width: 15px; height: 15px; background-color: grey; margin-right: 5px;"></span> RAL9007 Grey Metallic</div> <div><span style="display: inline-block; width: 15px; height: 15px; background-color: white; margin-right: 5px;"></span> RAL9016 White</div> <div><span style="display: inline-block; width: 15px; height: 15px; background-color: darkgrey; margin-right: 5px;"></span> RAL8019 Dark Bronze</div> </div>
Gasket	Silicone CCG® Controlled Compression Gasket
Fasteners	PCS Polymer Coated Stainless Steel Hardware
Ingress protection	IP66
Impact resistance	IK07
Corrosion resistance	5CE
Windage	1.176

**Electrical description**

Power supply	Integral [ECG] electronic driver 120V-277V. DMX enabled driver.
Driver / Ballast	120-277V DMX
Surge protection	Integral 10kV Surge Protector

**WE-EF LIGHTING USA, LLC**

410-D Keystone Drive, 15086 Warrendale, PA 15086 - Phone: +1 724 742 0030

customersupport.usa@we-ef.com - <https://we-ef.com/us>

Subject to technical changes and errors. - Generated on 12/13/2025

**FLC240 LED TUNABLE WHITE**

---

**Additional information**

---

Lifetime	Ta=25°/40° L90B10 > 90000h
Listings	ETL, UL-1598, CSA-C22.2#250.0. Suitable for Wet Locations. Meets ANSI C136.31 - 3G Vibration Rating for Bridge and Overpass Applications.

---

**FLC240 LED TUNABLE WHITE**

**Mounting Accessories**

**Pole clamp TS**

Description	Part ID	D1	Weight (lb)	D
TS1-2/M12 Pole clamp, single (Ø 3"-3.5")	147-0543	3.0-3.50	3.31	76-89

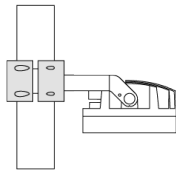
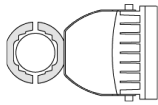

D1

TS1-2/M12 Pole clamp, single (Ø 4.0"-4.5")	147-0526	4.0-4.5	3.53	102-114
--	----------	---------	------	---------

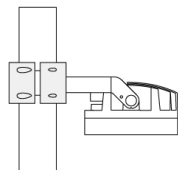
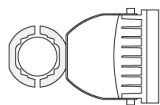

D1

**FLC240 LED TUNABLE WHITE**

Description	Part ID	D1	Weight (lb)	D
TS1-2/M12 Pole clamp, single (Ø 4.5"-5.25")	147-0544	4.5"-5.25"	3.75	114-133

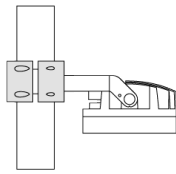
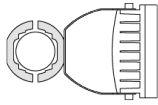

D1

TS2-2/M12 Pole clamp, double (Ø 3"-3.5")	147-0545	3.0"-3.5"	3.09 lbs	76-89
--	----------	-----------	----------	-------

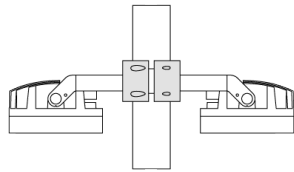
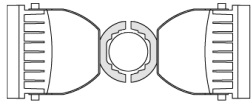

D1

**FLC240 LED TUNABLE WHITE**

Description	Part ID	D1	Weight (lb)	D
TS2-2/M16 Pole clamp, double (Ø 4.0"-4.5")	147-0527	4.0-4.50	3.31	102-114

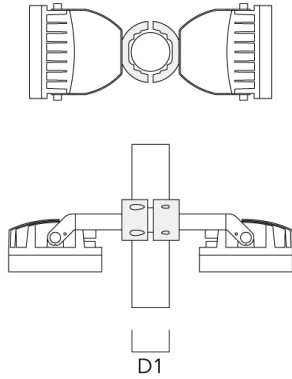

TS2-2/M16 Pole clamp, double (Ø 4.5"-5.25")	147-0546	4.50-5.25	3.53	114-133
---	----------	-----------	------	---------

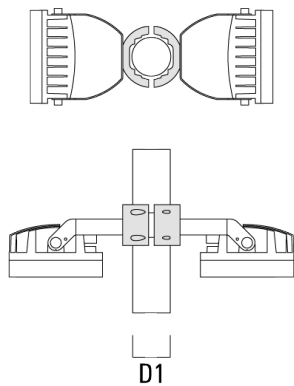

**FLC240 LED TUNABLE WHITE**

**Floodlight mounting bracket TA**

Description	Part ID	A	C1	D x L1	L	Weight (lb)	D x S
TA2-L Mounting bracket, double (Ø 3 x 8)	147-0105	±90°	16.54	3 x 8	2.99	35.49	76 x 200

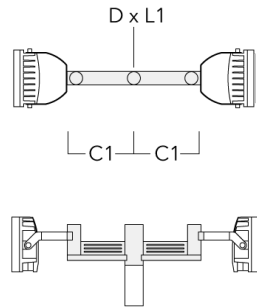

TA3 Mounting bracket, triple (Ø 3.50 x 8)	147-0025	±90°	25.59	3.50 x 8	3.5	39.46	89 x 200
---	----------	------	-------	----------	-----	-------	----------

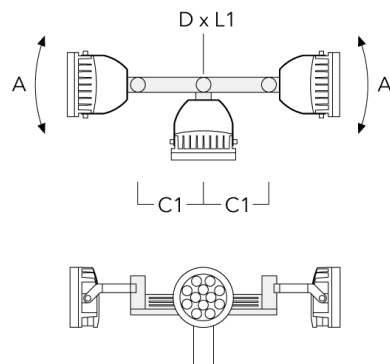

**FLC240 LED TUNABLE WHITE**

Description	Part ID	A	C1	D x L1	L	Weight (lb)	D x S
TA4 Mounting bracket, quad (Ø 3.50 x 8)	147-0099	±90°	25.59	3.50 x 8		45.86 lbs	89 x 200

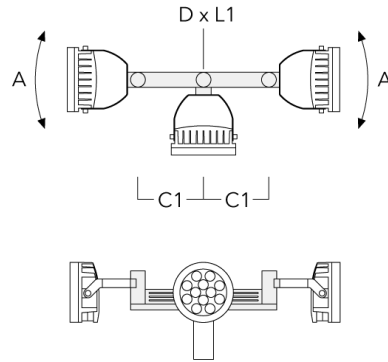

TA1 Mounting bracket, single (Ø 4.25 x 8)	147-0096		5.12	4.25 x 8	4.25	16.53	108 x 200
---	----------	--	------	----------	------	-------	-----------

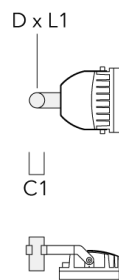



**FLC240 LED TUNABLE WHITE**

Description	Part ID	A	C1	D x L1	L	Weight (lb)	D x S
TA2-L Mounting bracket, double (Ø 4.25 x 8)	147-0148	±90°	16.54	4.25 x 8	4.25	44.53	108 x 200

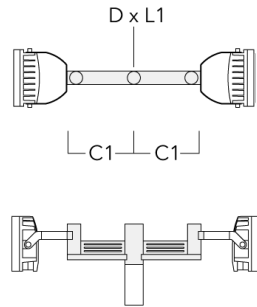

TA3 Mounting bracket, triple (Ø 4.25 x 8)	147-0098	±90°	25.59"	4.25 x 8		53.35 lbs	108 x 200
---	----------	------	--------	----------	--	-----------	-----------

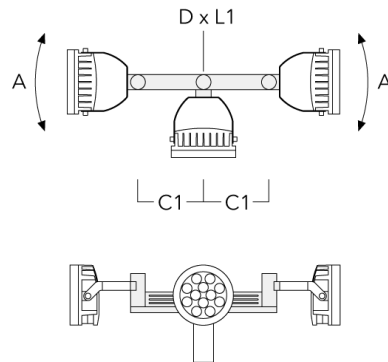

**FLC240 LED TUNABLE WHITE**

Description	Part ID	A	C1	D × L1	L	Weight (lb)	D × S
TA4 Mounting bracket, quad (Ø 4.25 x 8)	147-0100	±90°	650	4.25 x 8		53.00	108 x 200

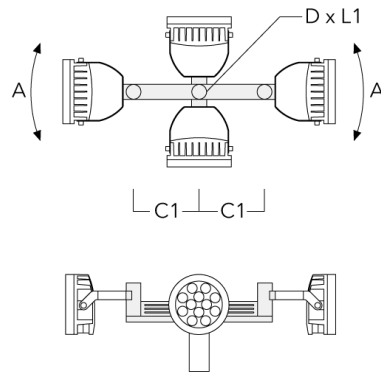

**Pole top caps KF**

Description	Part ID	D1	D × L1	Weight (lb)	D
KF16-60/M16 Spigot Cap (Ø 2.36")	310-9120	2.36	2.36 x 4	4.4 lbs	60 x 100

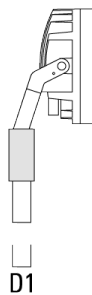

**FLC240 LED TUNABLE WHITE**

---

Description	Part ID	D1	D × L1	Weight (lb)	D
KF16-76/M16 Spigot Cap (Ø 3.0")	310-9121	3	3 x 4	1.10 lbs	76 x 100

---

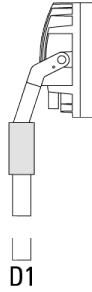

---

KF16-89/M16 Spigot Cap (Ø 3.5")	300-0734	3.50	3.5 x 3	1.10 lbs	89
---------------------------------	----------	------	---------	----------	----

---

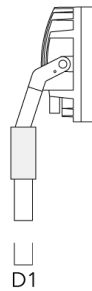

**FLC240 LED TUNABLE WHITE**

Description	Part ID	D1	D × L1	Weight (lb)	D
KF16-108/M16 Spigot Cap (Ø 4.25")	300-0735	4.25	4.25 x 3	4.4 lbs	108

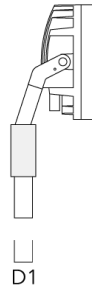

**Pole Mount Brackets PMB**

Description	Part ID	C1	C2	D1	D2	H1	H2	Weight (lb)
PMB200-1 Pole mount bracket	147-6017	39.67	20.09	6.0	3 x 3 + 4 x 3	28.94	15.89	37.8 lbs

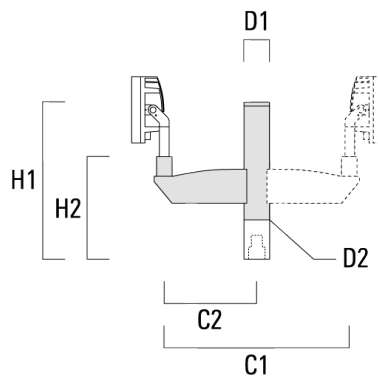

**FLC240 LED TUNABLE WHITE**

Description	Part ID	C1	C2	D1	D2	H1	H2	Weight (lb)
PMB200-2 Pole mount bracket	147-6018	39.67	20.09	6.0	3 x 3 + 4 x 3	28.94	15.89	57.0 lbs

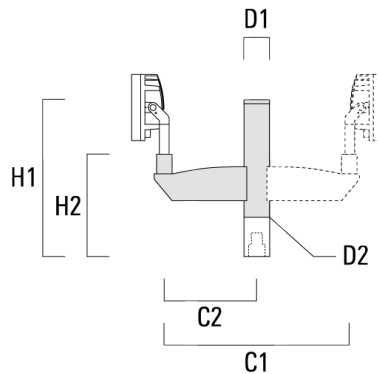

**Short post EM**

Description	Part ID	D1	D2	H1	M1	Weight (lb)
EM1-M16 AL	270-0001	6.3"	5.12"	8"	0.35"	4.85 lbs

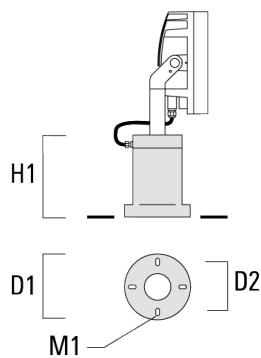

**FLC240 LED TUNABLE WHITE**

---

**Surface Mount Canopy SMC**

Description	Part ID	D1	D2	Weight (lb)
SMC-200	147-6915	10.83	9.25	15.4 lbs

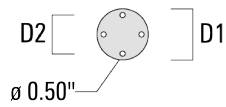

**FLC240 LED TUNABLE WHITE**

**Junction box**

Description	Part ID	Additional information	A	B	C1	Weight (lb)
Junction box JB20 - Cable side entries	310-9013	Junction boxes are made from marine-grade, die-cast aluminium alloy. IK10. IP66. For side entries and suitable to be used with cable glands.	7.09	5.63	2.01	2.25

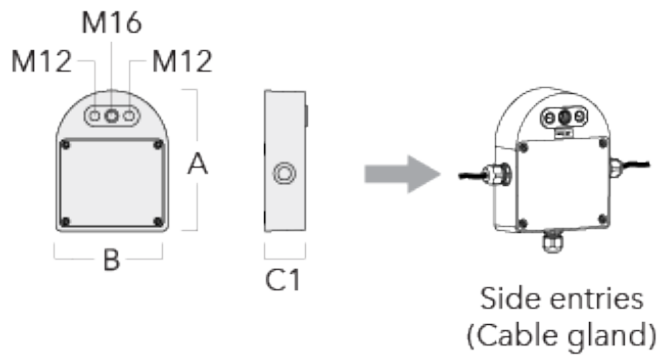

Junction box JB20 - Conduit side entries	310-9014	Junction boxes are made from marine-grade, die-cast aluminium alloy. IK10. IP66. For side entries and suitable to be used with conduits.	7.09	5.63	2.01	2.25
--	----------	--	------	------	------	------

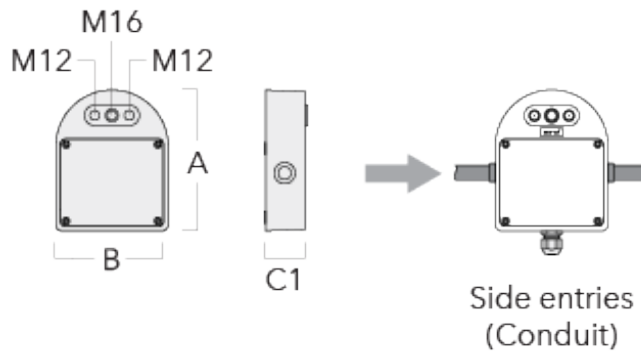

**FLC240 LED TUNABLE WHITE**

**Pole clamp PC**

Description	Part ID	D1	Weight (lb)
PC2 76-89/60 Pole clamp, double (Ø 3"-3.5")	139-2703	3.0-3.50	2.20

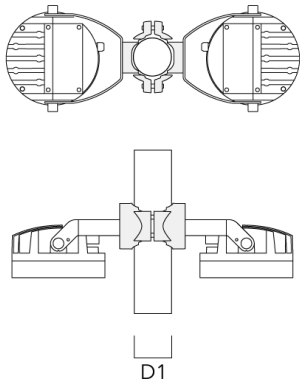

PC1 76-89/60 Pole clamp, single (Ø 3"-3.5")	139-2702	3.0-3.50	2.20
---	----------	----------	------

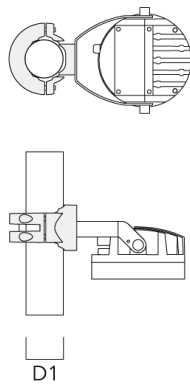



**FLC240 LED TUNABLE WHITE**

Description	Part ID	D1	Weight (lb)
PC2 102-114/60 Pole clamp, double (Ø 4"-4.5")	139-2707	4.0-4.50	2.65

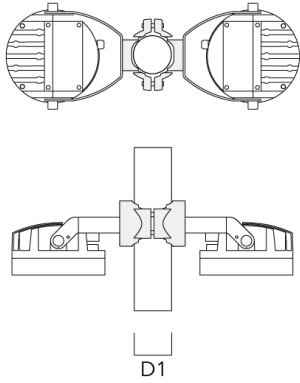

PC1 102-114/60 Pole clamp, single (Ø 4"-4,5")	139-2706	4.0-4.50	2.65
--	----------	----------	------

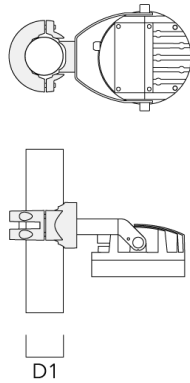

**FLC240 LED TUNABLE WHITE**

Description	Part ID	D1	Weight (lb)
PC2 114-133/60 Pole clamp, double (Ø 4.5"-5.25")	139-2709	4.5-5.25	3.10

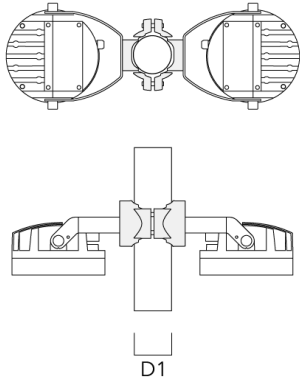

PC1 114-133/60 Pole clamp, single (Ø 4.5"-5.25")	139-2708	4.5-5.25	3.10
---	----------	----------	------

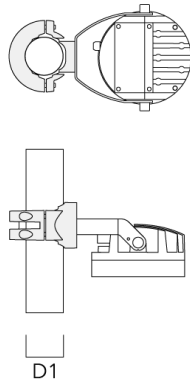

**FLC240 LED TUNABLE WHITE**

Description	Part ID	D1	Weight (lb)
PC2 82-109/60 Pole clamp, double (Ø 3.25"-4.25")	139-2705	3.20-4.30	2.40

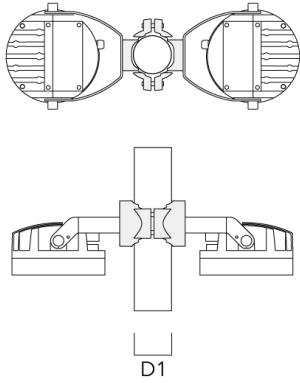

PC1 82-109/60 Pole clamp, single (Ø 3.25"-4.3")	139-2704	3.20-4.30	2.40
---	----------	-----------	------

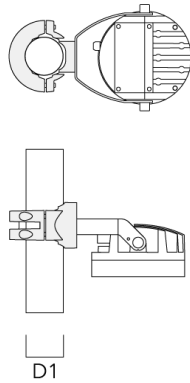

**FLC240 LED TUNABLE WHITE**

**Optical Accessories**

**Snoot**

Description	Part ID	A	C1
ET-FLC240-LED	139-1859	7.87	11.50

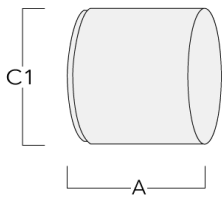

ET-FLC240-CC-LED	139-6975	7.87	13.62
------------------	----------	------	-------

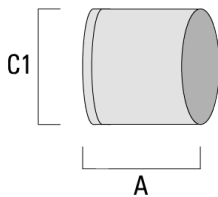

**FLC240 LED TUNABLE WHITE**

---

**Glare shield**

---

Description	Part ID	A	C1
ES-FLC240-LED	139-1858	7.87	13.62

---

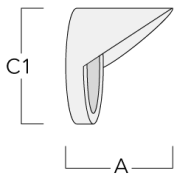

---

ES-FLC240-CC-LED	139-6971	7.87	13.62
------------------	----------	------	-------

---

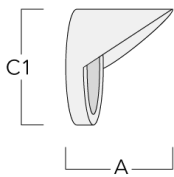

**FLC240 LED TUNABLE WHITE**

**Wallwash lens**

Description	Part ID	Additional information	C1
IO-20-FLC240-LED	139-1854	for symmetric [M] medium beam luminaire only	11.40

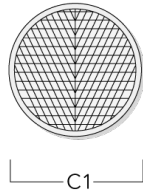

**Linear spread lens**

Description	Part ID	C1
Linear spread lens IO-180	139-1855	11.40

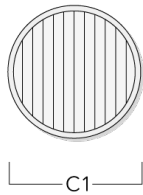

**FLC240 LED TUNABLE WHITE**

---

**Control**

**DMX Booster Box**

---

Description	Part ID
DMX Booster Box	400-0474

---



**FLC240 LED TUNABLE WHITE**

---

**DMX Combination Cable**

---

Description	Part ID
DMX Combination Cable	400-0480



---

**DMX Controller**

---

Description	Part ID	Additional information
DMX Controller	400-0469	IP20. DIN Rail system. Is designed for either live or stand-alone control. It features one DMX universe, a USBconnection, 128k flash memory for storing stand-alone programs.

---



**FLC240 LED TUNABLE WHITE**

---

**DMX Controller (smart)**

---

Description	Part ID	Additional information
DMX Controller (smart)	400-0470	IP20. The Touch Panel is an intuitive and easy-to use keypad or one DMX universe. It can store up to 36 scenes; alternatively, via ....

---



**FLC240 LED TUNABLE WHITE**

---

**DMX Plug and Socket**

---

Description	Part ID
DMX Plug and Socket	400-0479

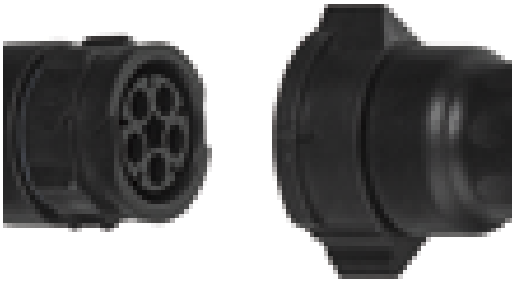

---

**DMX Termination Plug**

---

Description	Part ID
DMX Termination Plug	400-0475



**FLC240 LED TUNABLE WHITE**

---

**DMX Wireless Antenna**

---

Description	Part ID
DMX Wireless	430-0018

---

**DMX Wireless Transceiver**

---

Description	Part ID
DMX Wireless Transceiver	400-0476

---



**FLC240 LED TUNABLE WHITE**

---

**DMX Wireless Repeater**

---

Description	Part ID
DMX Wireless Repeater	400-0477

---

