

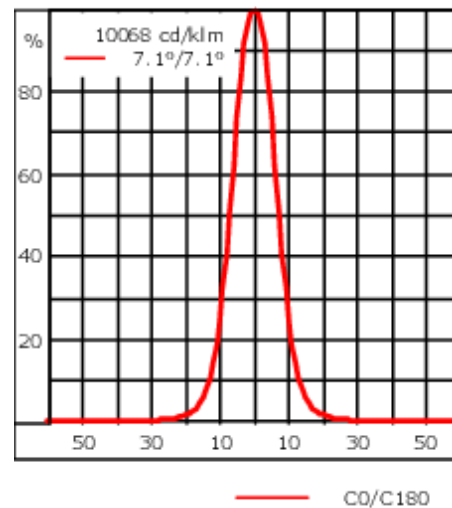

### Beschreibung

Tunable White. IP66, SKI. SKII auf Anfrage. IK07. Korrosionsbeständiger Aluminiumguss. PCS beschichtete Edelstahlschrauben. 5CE Korrosionsschutz. CCG® Silikonichtung. Sicherheitsglas. Eine Kabelverschraubung, eine zweite Kabelverschraubung zur Durchverdrahtung auf Anfrage. Eingebaute elektronische Betriebsgeräte, thermisch getrennt. CAD-optimierte OLC® One LED Concept Technik zur Lichtlenkung und Entblendung. Eingebaute LED Platine mit Tunable White Technologie. DALI Schnittstelle.

Gewicht	13.80 kg
Lichtverteilung	symmetrisch engstrahlend [E]
Lichtquelle	LED-24/88W - 2200-6000 K
CRI	80
Netz	EVG
LEDs	24
Bemessungsleistung	102 W
<b>Nominal Lichtstrom (lm)</b>	
LED Lumen	420
Total Lumen	10080
Tj	85
<b>Bemessungslichtstrom (lm)</b>	
LED Lumen	344.1
Total Lumen	8257.8
Ta	25

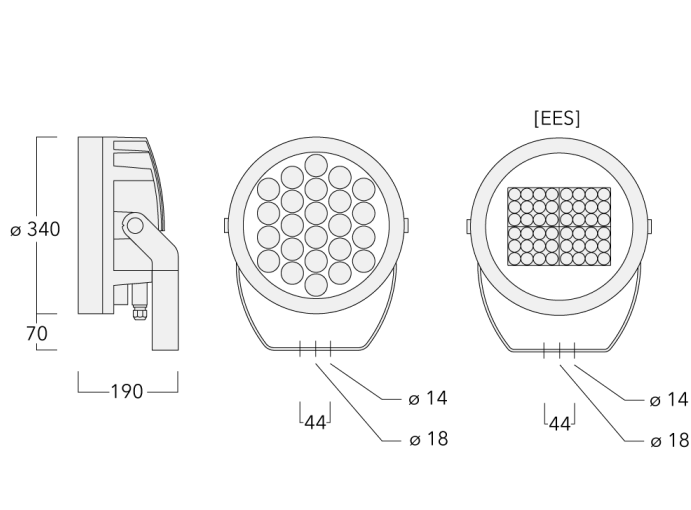

## Spezifikationen

### Materialbeschreibung

Gehäuse	Korrosionsbeständiges Aluminium
Abdeckung	Sicherheitsglasscheibe
Farben	<div style="display: flex; flex-direction: column; gap: 5px;"> <div style="display: flex; align-items: center;"> <div style="width: 20px; height: 15px; background-color: black; margin-right: 5px;"></div> <span>RAL9004 Signalschwarz</span> </div> <div style="display: flex; align-items: center;"> <div style="width: 20px; height: 15px; background-color: #cccccc; margin-right: 5px;"></div> <span>RAL9006 Weißaluminium</span> </div> <div style="display: flex; align-items: center;"> <div style="width: 20px; height: 15px; background-color: #808080; margin-right: 5px;"></div> <span>RAL9007 Graualuminium</span> </div> <div style="display: flex; align-items: center;"> <div style="width: 20px; height: 15px; background-color: #333333; margin-right: 5px;"></div> <span>RAL7016 Anthrazitgrau</span> </div> <div style="display: flex; align-items: center;"> <div style="width: 20px; height: 15px; background-color: #e0e0e0; margin-right: 5px;"></div> <span>RAL9016 Verkehrsweiß</span> </div> </div>
Dichtung	CCG® Silikondichtung
Schrauben	PCS beschichtete Edelstahlschrauben
Schutzart	IP66
Schlagfestigkeit	IK07
Korrosionsbeständigkeit	5CE
Windangriffsfläche	0.090 m <sup>2</sup>

### Elektrische Beschreibung

Netz	220-240V / 50-60 Hz
Netzgerät / Vorschaltgerät	DALI
Leistungsfaktor	> 0.9
Überspannungsschutz	1/2 kV (optional SP10)

#### WE-EF LEUCHTEN GmbH

Töpinger Straße 16, 29646 Bispingen, Germany - Tel: +49 5194 909-0  
 info.germany@we-ef.com - <https://we-ef.com/de>

Technische Änderungen und Irrtümer vorbehalten. - Erstellt am 23.11.2024

**139-2049**

**FLC240-TW LED**

**we-ef**

**Weitere Informationen**

---

Lebensdauer	Ta=25° L90B10 > 90000h
-------------	------------------------

---

**WE-EF LEUCHTEN GmbH**

Töpinger Straße 16, 29646 Bispingen, Germany - Tel: +49 5194 909-0  
info.germany@we-ef.com - <https://we-ef.com/de>

Technische Änderungen und Irrtümer vorbehalten. - Erstellt am 23.11.2024

## Montagezubehör

## Mastschelle TS

Beschreibung	Artikelnummer	D1	Gewicht (kg)	D
TS1-2/M12 Mastschelle, einfach (Ø 76-89)	147-0543	76-89	1.40	76-89

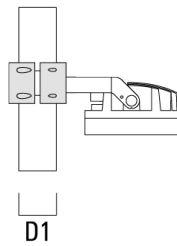
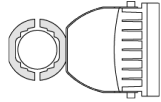

TS1-2/M12 Mastschelle, einfach (Ø 102-114)	147-0526	102-114	1.50	102-114
--	----------	---------	------	---------

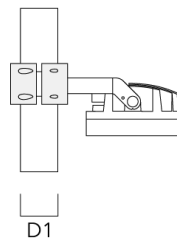
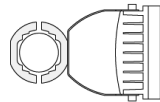

## FLC240-TW LED

Beschreibung	Artikelnummer	D1	Gewicht (kg)	D
TS1-2/M12 Mastschelle, einfach (Ø 114-133)	147-0544	114-133	1.70	114-133

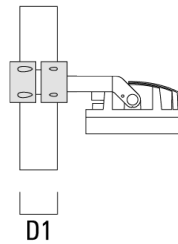
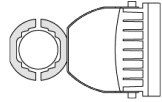

TS2-2/M12 Mastschelle, zweifach (Ø 76-89)	147-0545	76-89	1.40	76-89
---	----------	-------	------	-------

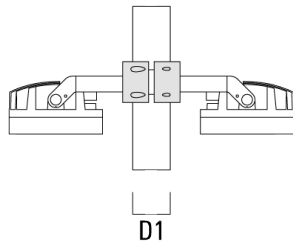
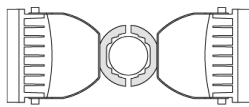

## FLC240-TW LED

Beschreibung	Artikelnummer	D1	Gewicht (kg)	D
TS2-2/M12 Mastschelle, zweifach (Ø 102-114)	147-0527	102-114	1.50	102-114

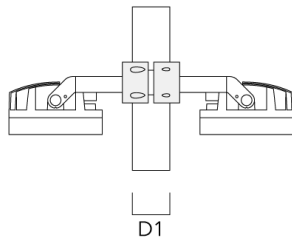
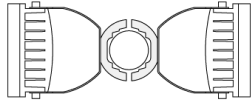

TS2-2/M12 Mastschelle, zweifach (Ø 114-133)	147-0546	114-133	1.60	114-133
---	----------	---------	------	---------

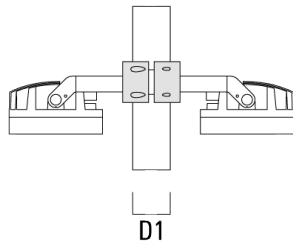
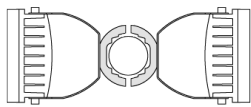

## Mastaufsatztraverse TA

Beschreibung	Artikelnummer	A	C1	D x L1	Gewicht (kg)	D x S
TA2-L Mastaufsatztraverse, zweifach (Ø 76 x 200)	147-0105	±90°	420	76 x 200	16.10	76 x 200

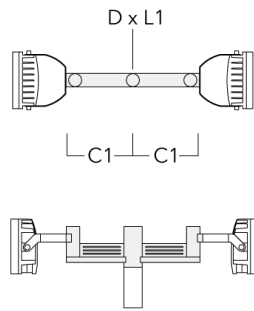

TA3 Mastaufsatztraverse, dreifach (Ø 89 x 200)	147-0025	±90°	650	89 x 200	17.90	89 x 200
--	----------	------	-----	----------	-------	----------

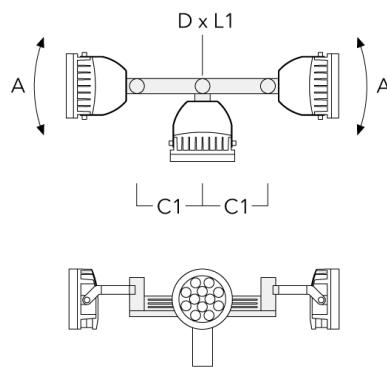

## FLC240-TW LED

Beschreibung	Artikelnummer	A	C1	D × L1	Gewicht (kg)	D × S
TA4 Mastaufsatztraverse, vierfach (Ø 89 x 200)	147-0099	±90°	650	89 x 200	20.80	89 x 200

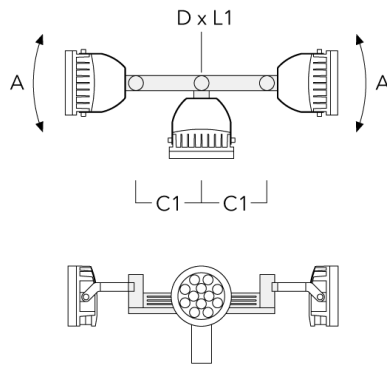

TA1 Mastaufsatztraverse, einfach (Ø 108 x 200)	147-0096		130	108 x 200	7.50	108 x 200
--	----------	--	-----	-----------	------	-----------

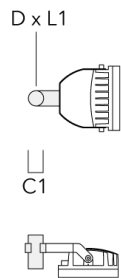



## FLC240-TW LED

Beschreibung	Artikelnummer	A	C1	D × L1	Gewicht (kg)	D × S
TA2 Mastaufsatztraverse, zweifach (Ø 108 x 200)	147-0097		130	108 x 200	7.50	108 x 200

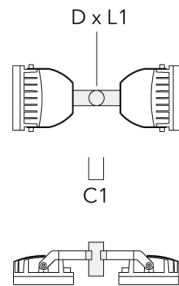

TA2-L Mastaufsatztraverse, zweifach (Ø 108 x 200)	147-0148	±90°	420	108 x 200	20.20	108 x 200
---	----------	------	-----	-----------	-------	-----------

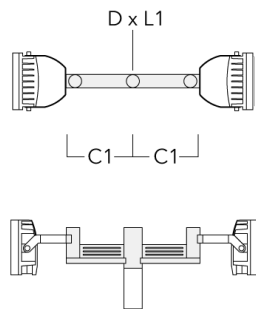

## FLC240-TW LED

Beschreibung	Artikelnummer	A	C1	D x L1	Gewicht (kg)	D x S
TA3 Mastaufsatztraverse, dreifach (Ø 108 x 200)	147-0098	±90°	650	108 x 200	24.20	108 x 200

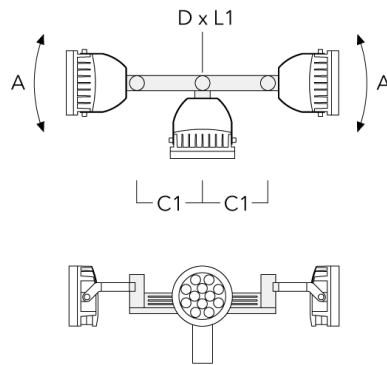

TA4 Mastaufsatztraverse, vierfach (Ø 108 x 200)	147-0100	±90°	650	108 x 200	24.20	108 x 200
---	----------	------	-----	-----------	-------	-----------

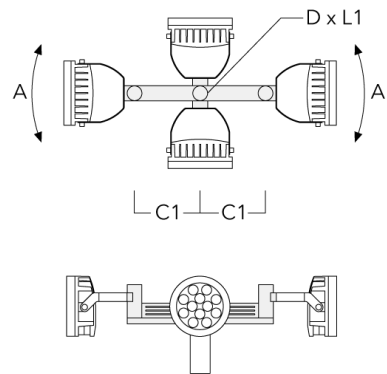

**Mastschelle PC**

Beschreibung	Artikelnummer	D1	Gewicht (kg)
PC2 76-89/60 Mastschelle, zweifach (Ø 76-89)	139-2703	76-89	1.00



PC1 76-89/60 Mastschelle, einfach (Ø 76-89)	139-2702	76-89	1.00
---	----------	-------	------

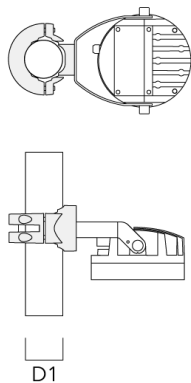

## FLC240-TW LED

Beschreibung	Artikelnummer	D1	Gewicht (kg)
PC2 102-114/60 Mast­schelle, zweifach (Ø 102-114)	139-2707	102-114	1.20



PC1 102-114/60 Mast­schelle, einfach (Ø 102-114)	139-2706	102-114	1.20
---	----------	---------	------



## FLC240-TW LED

Beschreibung	Artikelnummer	D1	Gewicht (kg)
PC2 114-133/60 Mastschelle, zweifach (Ø 114-133)	139-2709	114-133	1.40



PC1 114-133/60 Mastschelle, einfach (Ø 114-133)	139-2708	114-133	1.40
--	----------	---------	------



139-2049

FLC240-TW LED

**we-ef**

---

Beschreibung	Artikelnummer	D1	Gewicht (kg)
PC2 82-109/60 Mastschelle, zweifach (Ø 82-109)	139-2705	82-109	1.10

---

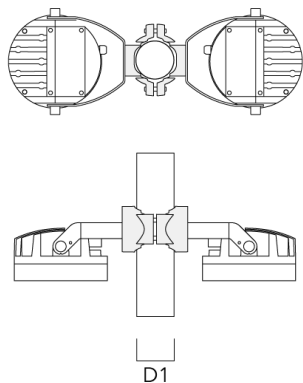

**WE-EF LEUCHTEN GmbH**

Töpinger Straße 16, 29646 Bispingen, Germany - Tel: +49 5194 909-0

info.germany@we-ef.com - <https://we-ef.com/de>

Technische Änderungen und Irrtümer vorbehalten. - Erstellt am 23.11.2024

**Optisches Zubehör****Abblendtubus**

Beschreibung	Artikelnummer	A	C1
ET-FLC240-LED	139-1859	200	346

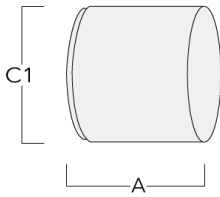
**Seitenblende**

Beschreibung	Artikelnummer	A	C1
ES-FLC240-LED	139-1858	200	346

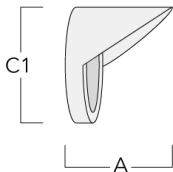

139-2049

FLC240-TW LED

**we-ef**

### Wallwash Linse

Beschreibung	Artikelnummer	Weitere Informationen	C1
IO-20-FLC240-LED	139-1854	for symmetric [M] medium beam luminaire only	289

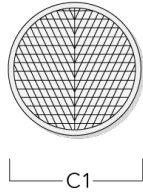

### Streulinse bandförmig

Beschreibung	Artikelnummer	C1
Linear spread lens IO-180	139-1855	289

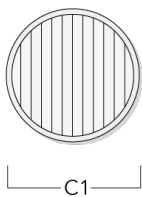

#### WE-EF LEUCHTEN GmbH

Töpinger Straße 16, 29646 Bispingen, Germany - Tel: +49 5194 909-0

info.germany@we-ef.com - <https://we-ef.com/de>

Technische Änderungen und Irrtümer vorbehalten. - Erstellt am 23.11.2024



**139-2049**

**FLC240-TW LED**

**we-ef**

## Steuerung

### DMX Wireless Repeater

---

Beschreibung	Artikelnummer
DMX Wireless Repeater	400-0477

---



---

### DMX Wireless Transceiver

---

Beschreibung	Artikelnummer
DMX Wireless Transceiver	400-0476

---



---

#### WE-EF LEUCHTEN GmbH

Töpinger Straße 16, 29646 Bispingen, Germany - Tel: +49 5194 909-0

info.germany@we-ef.com - <https://we-ef.com/de>

Technische Änderungen und Irrtümer vorbehalten. - Erstellt am 23.11.2024

**139-2049**

**FLC240-TW LED**

**we-ef**

**R2C Ready to Connect**

Beschreibung	Artikelnummer
R2C Ready to Connect (oben)	430-0019

**WE-EF LEUCHTEN GmbH**

Töpinger Straße 16, 29646 Bispingen, Germany - Tel: +49 5194 909-0

info.germany@we-ef.com - <https://we-ef.com/de>

Technische Änderungen und Irrtümer vorbehalten. - Erstellt am 23.11.2024