

139-2051

FLC260-TW LED

**we-ef**



### Beschreibung

Tunable White. IP66, SKI. SKII auf Anfrage. IK07. Korrosionsbeständiger Aluminiumguss. PCS beschichtete Edelstahlschrauben. 5CE Korrosionsschutz. CCG® Silikonichtung. Sicherheitsglas. Eine Kabelverschraubung, eine zweite Kabelverschraubung zur Durchverdrahtung auf Anfrage. Eingebaute elektronische Betriebsgeräte, thermisch getrennt. CAD-optimierte OLC® One LED Concept Technik zur Lichtlenkung und Entblendung. Eingebaute LED Platine mit Tunable White Technologie DALI Schnittstelle.

Gewicht	18.50 kg
Lichtverteilung	symmetrisch mediumstrahlend [M]
Lichtquelle	LED-36/132W - 2200-6000 K
CRI	80
Netz	EVG
LEDs	36
Bemessungsleistung	152 W
<b>Nominal Lichtstrom (lm)</b>	
LED Lumen	420
Total Lumen	15120
Tj	85
<b>Bemessungslichtstrom (lm)</b>	
LED Lumen	338.2
Total Lumen	12174
Ta	25

### WE-EF LEUCHTEN GmbH

Töpinger Straße 16, 29646 Bispingen, Germany - Tel: +49 5194 909-0  
info.germany@we-ef.com - <https://we-ef.com/de>

Technische Änderungen und Irrtümer vorbehalten. - Erstellt am 23.11.2024

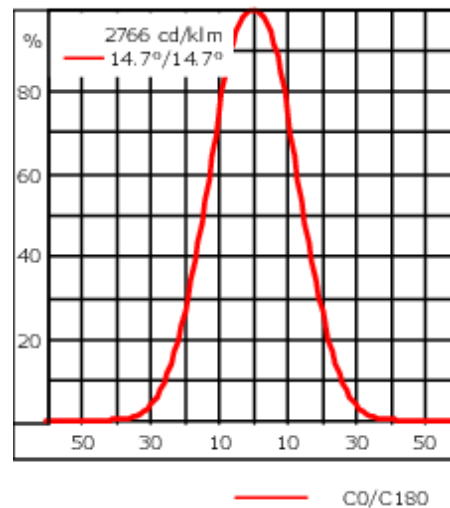
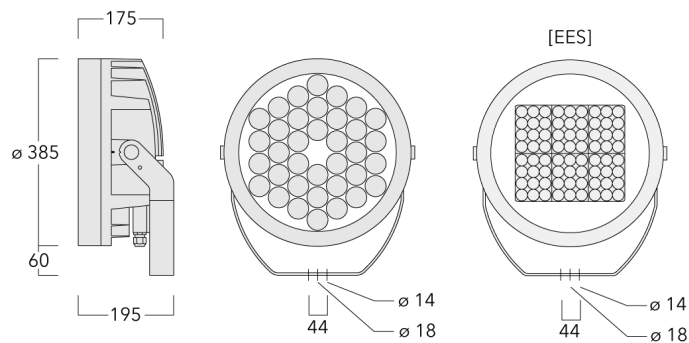

## Spezifikationen

### Materialbeschreibung

Gehäuse	Korrosionsbeständiges Aluminium
Abdeckung	Sicherheitsglasscheibe
Farben	<div style="display: flex; flex-direction: column; gap: 5px;"> <div style="display: flex; align-items: center;"> <div style="width: 20px; height: 10px; background-color: black; margin-right: 5px;"></div> <span>RAL9004 Signalschwarz</span> </div> <div style="display: flex; align-items: center;"> <div style="width: 20px; height: 10px; background-color: #cccccc; margin-right: 5px;"></div> <span>RAL9006 Weißaluminium</span> </div> <div style="display: flex; align-items: center;"> <div style="width: 20px; height: 10px; background-color: #808080; margin-right: 5px;"></div> <span>RAL9007 Graualuminium</span> </div> <div style="display: flex; align-items: center;"> <div style="width: 20px; height: 10px; background-color: #333333; margin-right: 5px;"></div> <span>RAL7016 Anthrazitgrau</span> </div> <div style="display: flex; align-items: center;"> <div style="width: 20px; height: 10px; background-color: #e0e0e0; margin-right: 5px;"></div> <span>RAL9016 Verkehrsweiß</span> </div> </div>
Dichtung	CCG® Silikondichtung
Schrauben	PCS beschichtete Edelstahlschrauben
Schutzart	IP66
Schlagfestigkeit	IK07
Korrosionsbeständigkeit	5CE
Windangriffsfläche	0.116 m <sup>2</sup>

### Elektrische Beschreibung

Netz	220-240V / 50-60 Hz
Netzgerät / Vorschaltgerät	DALI
Leistungsfaktor	> 0.9
Überspannungsschutz	1/2 kV (optional SP10)

#### WE-EF LEUCHTEN GmbH

Töpinger Straße 16, 29646 Bispingen, Germany - Tel: +49 5194 909-0

info.germany@we-ef.com - <https://we-ef.com/de>

Technische Änderungen und Irrtümer vorbehalten. - Erstellt am 23.11.2024

**139-2051**

**FLC260-TW LED**

**we-ef**

### Weitere Informationen

---

Lebensdauer Ta=25° L90B10 > 90000h

Energieeffizienzklasse E (Lichtquelle)

---

**WE-EF LEUCHTEN GmbH**

Töpinger Straße 16, 29646 Bispingen, Germany - Tel: +49 5194 909-0

info.germany@we-ef.com - <https://we-ef.com/de>

Technische Änderungen und Irrtümer vorbehalten. - Erstellt am 23.11.2024

**139-2051**

**FLC260-TW LED**

**we-ef**

## Optisches Zubehör

### Wallwash Linse

Beschreibung	Artikelnummer	C1
IO-20-FLC260-LED	139-1860	332

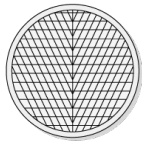

C1

### Streulinse bandförmig

Beschreibung	Artikelnummer	C1
IO-180-FLC260-LED	139-1861	332

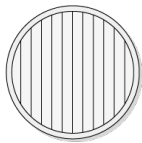

C1

#### WE-EF LEUCHTEN GmbH

Töpinger Straße 16, 29646 Bispingen, Germany - Tel: +49 5194 909-0

info.germany@we-ef.com - <https://we-ef.com/de>

Technische Änderungen und Irrtümer vorbehalten. - Erstellt am 23.11.2024

**Abblendtubus**

Beschreibung	Artikelnummer	A	C1
ET-FLC260-LED	139-1865	222	393

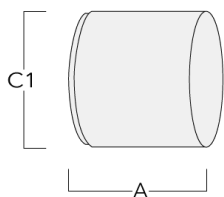
**Seitenblende**

Beschreibung	Artikelnummer	A	C1
ES-FLC260-LED	139-1864	222	393

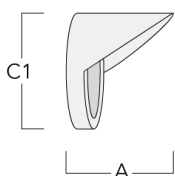

139-2051

FLC260-TW LED

**we-ef**

## Montagezubehör

### Mastschelle TS

Beschreibung	Artikelnummer	D1	Gewicht (kg)	D
TS1-2/M12 Mastschelle, einfach (Ø 114-133)	147-0544	114-133	1.70	114-133

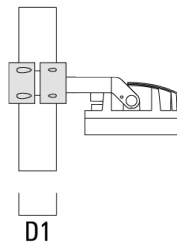
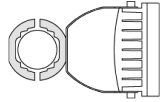

TS2-2/M12 Mastschelle, zweifach (Ø 76-89)	147-0545	76-89	1.40	76-89
---	----------	-------	------	-------

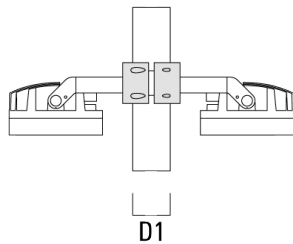
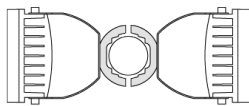

#### WE-EF LEUCHTEN GmbH

Töpinger Straße 16, 29646 Bispingen, Germany - Tel: +49 5194 909-0

info.germany@we-ef.com - <https://we-ef.com/de>

Technische Änderungen und Irrtümer vorbehalten. - Erstellt am 23.11.2024

**Mastaufsatztraverse TA**

Beschreibung	Artikelnummer	C1	D x L1	Gewicht (kg)	D x S
TA1 Mastaufsatztraverse, einfach* (Ø 76 x 200)	147-0023	130	76 x 200	1.90	76 x 200

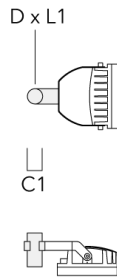
**Mastschelle PC**

Beschreibung	Artikelnummer	D1	Gewicht (kg)
PC2 76-89/60 Mastschelle, zweifach (Ø 76-89)	139-2703	76-89	1.00

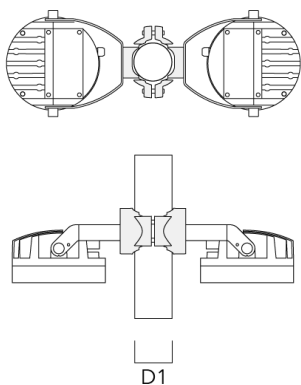

## FLC260-TW LED

Beschreibung	Artikelnummer	D1	Gewicht (kg)
PC1 76-89/60 Mastschelle, einfach (Ø 76-89)	139-2702	76-89	1.00

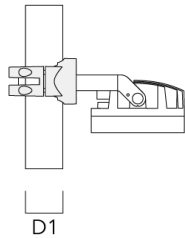
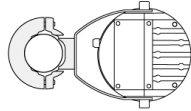

D1

PC2 102-114/60 Mastschelle, zweifach (Ø 102-114)	139-2707	102-114	1.20
--	----------	---------	------

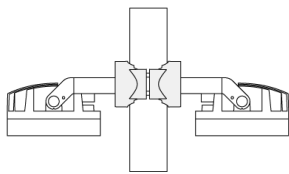
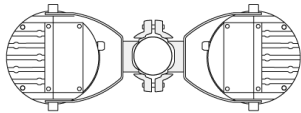

D1



Beschreibung	Artikelnummer	D1	Gewicht (kg)
PC1 102-114/60 Mast­schelle, einfach (Ø 102-114)	139-2706	102-114	1.20

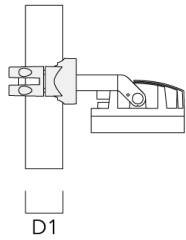
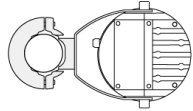

PC2 114-133/60 Mast­schelle, zweifach (Ø 114-133)	139-2709	114-133	1.40
--	----------	---------	------

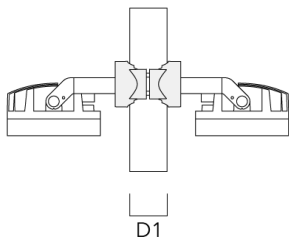
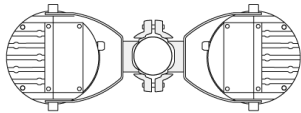

## FLC260-TW LED

---

Beschreibung	Artikelnummer	D1	Gewicht (kg)
PC1 114-133/60 Mastschelle, einfach (Ø 114-133)	139-2708	114-133	1.40

---

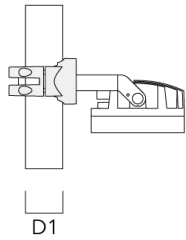
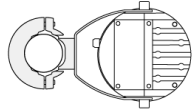

---

PC2 82-109/60 Mastschelle, zweifach (Ø 82-109)	139-2705	82-109	1.10
---	----------	--------	------

---

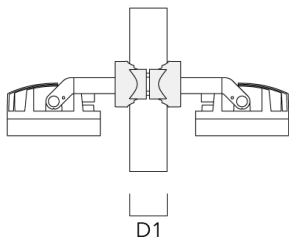
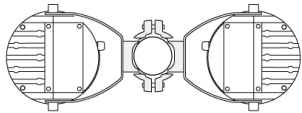

**139-2051**

**FLC260-TW LED**

**we-ef**

## Steuerung

### DMX Wireless Repeater

---

Beschreibung	Artikelnummer
DMX Wireless Repeater	400-0477

---



---

### DMX Wireless Transceiver

---

Beschreibung	Artikelnummer
DMX Wireless Transceiver	400-0476

---



---

#### WE-EF LEUCHTEN GmbH

Töpinger Straße 16, 29646 Bispingen, Germany - Tel: +49 5194 909-0

info.germany@we-ef.com - <https://we-ef.com/de>

Technische Änderungen und Irrtümer vorbehalten. - Erstellt am 23.11.2024